

---

**4090/40105**  
*9002/10512*  
*LD090/LD0105*  
**Aficio™ 2090/2105**

## Operating Instructions General Settings Guide



ZJBH050N

- 
- 1** What You Can Do with This Machine
  - 2** Getting Started
  - 3** Combined Function Operations
  - 4** Document Server
  - 5** User Tools (System Settings)
  - 6** Paper Tray Settings
  - 7** Troubleshooting
  - 8** Remarks
  - 9** Security
  - 10** Specification

For safe and correct operation of this machine, please be sure to read the Safety Information before you use it.

Type for 4090/9002/LD090/Aficio 2090  
Type for 40105/10512/LD0105/Aficio 2105  
Printed in Japan  
EN (USA) B071-8507

## Introduction

This manual contains detailed instructions on the operation and maintenance of this machine. To get maximum versatility from this machine all operators should carefully read and follow the instructions in this manual. Please keep this manual in a handy place near the machine.



## Notes

Some illustrations in this manual might be slightly different from the machine.

Certain options may not be available in some countries. For details, please contact your local dealer.



## Laser Safety:

### CDRH Regulations

This equipment complies with requirements of 21 CFR subchapter J for class 1 laser products. This equipment contains AlGaAs four beam laser diode array, 10-milliwatt, 770-810 nanometer wavelength for each emitter. This equipment does not emit hazardous light, since the beam is totally enclosed during all customer modes of operation and maintenance.

## Warning:

Use of controls, adjustment or performance of procedures other than those specified in this manual may result in hazardous radiation exposure.

The model names of the machines do not appear on the following pages. Check the type of your machine before reading this manual. (For details, see p.11 "Machine Types".)

- Type 1 : 4090/9002/LD090/Aficio 2090
- Type 2 : 40105/10512/LD0105/Aficio 2105

Certain types may not be available in some countries. For details, contact your local dealer.

Two kinds of size notation are employed in this manual. With this machine refer to the inch version.

For good copy quality, the manufacturer recommends that you use manufacturer-genuine toner.

The supplier shall not be responsible for any damage or expense that may result from use of parts other than manufacturer-genuine parts.

## Power Source

208-240V, 60Hz, 20A

Be sure to connect the power cord to a power source as above. For details about the power source, see p.144 "Power Connection".

In accordance with IEC 60417, this machine uses the following symbols for the main power switch:

**I** means **POWER ON.**

**⏻** means **STAND BY.**

### Note to users in the United States of America

**Notice:**

This equipment has been tested and found to comply with the limits for a Class B digital device, pursuant to Part 15 of the FCC Rules. These limits are designed to provide reasonable protection against harmful interference in a residential installation. This equipment generates, uses and can radiate radio frequency energy and, if not installed and used in accordance with the instructions, may cause harmful interference to radio communications. However, there is no guarantee that interference will not occur in a particular installation. If this equipment does cause harmful interference to radio or television reception, which can be determined by turning the equipment off and on, the user is encouraged to try to correct the interference by one more of the following measures:

**Reorient or relocate the receiving antenna.**

**Increase the separation between the equipment and receiver.**

**Connect the equipment into an outlet on a circuit different from that to which the receiver is connected.**

**Consult the dealer or an experienced radio /TV technician for help.**

**Warning**

Changes or modifications not expressly approved by the party responsible for compliance could void the user's authority to operate the equipment.

### Note to users in Canada

**Note:**

This Class B digital apparatus complies with Canadian ICES-003.

### Remarque concernant les utilisateurs au Canada

**Avertissement:**

Cet appareil numérique de la classe B est conforme à la norme NMB-003 du Canada.



# Manuals for This Machine

The following manuals describe the operational procedures of this machine. For particular functions, see the relevant parts of the manual.

## **Note**

- Manuals provided are specific to machine type.
- Adobe Acrobat Reader is necessary to view the manuals as a PDF file.
- Two CD-ROMs are provided:
  - CD-ROM 1 “Operating Instructions for Printer / Scanner”
  - CD-ROM 2 “Scanner Driver & Document Management Utilities”

## ❖ **General Settings Guide (this Manual)**

Provides an overview of the machine.

It also describes System Settings (such as paper trays and user codes settings), Document Server functions, and troubleshooting.

## ❖ **Network Guide (PDF file - CD-ROM1)**

Describes procedures for configuring the machine and computers in a network environment.

## ❖ **Copy Reference**

Describes operations, functions, and troubleshooting for the machine's copier function.

## ❖ **Printer Reference 1**

Describes system settings and operations for the machine's printer function.

## ❖ **Printer Reference 2 (PDF file - CD-ROM1)**

Describes operations, functions, and troubleshooting for the machine's printer function.

## ❖ **Scanner Reference (PDF file - CD-ROM1)**

Describes operations, functions, and troubleshooting for the machine's scanner function.

## ❖ **Manuals for DeskTopBinder V2 Lite**

DeskTopBinder V2 Lite is a utility included on the CD-ROM labeled “Scanner Driver & Document Management Utilities”.

- DeskTopBinder V2 Lite Setup Guide (PDF file - CD-ROM2)  
Describes installation of, and the operating environment for DeskTopBinder V2 Lite in detail. This guide can be displayed from the **[Setup]** dialog box when DeskTopBinder V2 Lite is installed.
- DeskTopBinder V2 Lite Introduction Guide (PDF file - CD-ROM2)  
Describes operations of DeskTopBinder V2 Lite and provides an overview of its functions. This guide is added to the **[Start]** menu when DeskTopBinder V2 Lite is installed.

- Auto Document Link Guide (PDF file - CD-ROM2)  
Describes operations and functions of Auto Document Link installed with DeskTopBinder V2 Lite. This guide is added to the **[Start]** menu when DeskTopBinder V2 Lite is installed.

❖ **Manuals for ScanRouter V2 Lite**

ScanRouter V2 Lite is a utility included on the CD-ROM labeled “Scanner Driver & Document Management Utilities”.

- ScanRouter V2 Lite Setup Guide (PDF file - CD-ROM2)  
Describes installation of, settings, and the operating environment for ScanRouter V2 Lite in detail. This guide can be displayed from the **[Setup]** dialog box when ScanRouter V2 Lite is installed.
- ScanRouter V2 Lite Management Guide (PDF file - CD-ROM2)  
Describes delivery server management and operations, and provides an overview of ScanRouter V2 Lite functions. This guide is added to the **[Start]** menu when ScanRouter V2 Lite is installed.

❖ **Other manuals**

- PS3 Supplement (PDF file - CD-ROM1)
- Unix Supplement (Available from an authorized dealer, or as a PDF file on our Web site.)

# TABLE OF CONTENTS

<b>Manuals for This Machine</b> .....	<b>i</b>
<b>Notice</b> .....	<b>1</b>
<b>Copyrights and Trademarks</b> .....	<b>2</b>
Trademarks .....	2
Information about Installed Software.....	2
<b>How to Read This Manual</b> .....	<b>5</b>
<b>Safety Information</b> .....	<b>6</b>
Safety During Operation.....	6
<b>Positions of Labels and Hallmarks for ⚠WARNING and ⚠CAUTION.....</b>	<b>8</b>
<b>ENERGY STAR Program</b> .....	<b>9</b>
<b>Machine Types</b> .....	<b>11</b>

## 1. What You Can Do with This Machine

---

<b>Available Functions</b> .....	<b>13</b>
Copier Mode.....	13
Printer Mode.....	13
Scanner Mode.....	13
Document Server Mode .....	14
User Management.....	16
Security Functions.....	16

## 2. Getting Started

---

<b>Guide to Components</b> .....	<b>17</b>
<b>External Options</b> .....	<b>19</b>
<b>Control Panel</b> .....	<b>20</b>
Display Panel .....	23
<b>Turning On the Power</b> .....	<b>24</b>
Turning On the Main Power .....	24
Turning On the Power .....	25
Turning Off the Power .....	25
Turning Off the Main Power .....	25

## 3. Combined Function Operations

---

<b>Changing Modes</b> .....	<b>27</b>
Saving Energy .....	28
Job List.....	29
<b>Multi-Access</b> .....	<b>32</b>

## 4. Document Server

---

<b>Relationship between Document Server and Other Functions</b> .....	<b>35</b>
Document Server Display .....	36
<b>Using the Document Server</b> .....	<b>37</b>
Storing Data .....	37
Changing the File Name, User Name, or Password .....	41
To Check Details of Stored Documents .....	42
Searching for Stored Documents .....	43
Printing Stored Documents .....	44
Print Selected Pages.....	48
Edit File .....	49
Deleting Stored Documents .....	51
Viewing Stored Documents on the Web Browser .....	52
Downloading Stored Documents.....	52
<b>Functions Available in Document Server Mode</b> .....	<b>53</b>
<b>Settings for the Document Server</b> .....	<b>56</b>

## 5. User Tools (System Settings)

---

<b>User Tools Menu (System Settings)</b> .....	<b>57</b>
<b>Accessing User Tools (System Settings)</b> .....	<b>60</b>
Changing the Default .....	60
Exiting User Tools .....	61
<b>Settings You Can Change with User Tools</b> .....	<b>62</b>
General Features .....	62
Timer Setting.....	66
Key Operator Tools .....	69
<b>User Codes</b> .....	<b>75</b>
Registering a New User Code.....	75
Changing a User Code.....	77
Deleting a User Code .....	78
Displaying the Counter for Each User Code .....	79
Printing the Counter for Each User Code.....	79
Clearing the Counter .....	80
<b>E-mail Destination</b> .....	<b>81</b>
Registering an E-mail Address.....	81
Changing a Registered E-mail Destination .....	83
Deleting a Registered E-mail Address .....	84
<b>Registering E-mail Destinations to a Group</b> .....	<b>86</b>
Registering a New Group .....	86
Registering E-mail Destinations to a Group .....	87
Deleting an E-mail Destination from a Group.....	88
Displaying the Destinations Registered in Groups.....	89
Changing a Group Name .....	90
Deleting a Group .....	90
<b>Entering Text</b> .....	<b>91</b>
Available Characters .....	91
Keys .....	91
Entering Text.....	92







## 6. Paper Tray Settings

---

<b>Accessing Paper Tray Settings</b> .....	<b>93</b>
Changing Paper Tray Settings .....	93
Exiting Paper Tray Settings.....	94
<b>Settings You Can Change with User Tools</b> .....	<b>95</b>
Tray Paper Settings .....	95
Designation Sheet 1-8.....	97
Front Cover .....	97
Back Cover.....	98
Slip Sheets .....	98
Separation Sheets.....	98

## 7. Troubleshooting

---

<b>If Your Machine Does Not Operate as You Want</b> .....	<b>99</b>
General .....	99
Document Server .....	101
 <b>Loading Paper</b> .....	<b>102</b>
Loading Paper in Tray 1 (Tandem Tray) .....	102
Loading Paper in Tray 2 and 3.....	104
Loading Paper in the Large Capacity Tray (Tray 4, Tray 5, and Tray 6).....	105
Loading Paper in the Optional A3/11" × 17" Tray Kit .....	106
Loading Paper in the Interposer.....	107
<b>Pausing Copy When Using Finisher 3000B (100–Sheet Staples)</b> .....	<b>110</b>
 <b>Adding Toner</b> .....	<b>111</b>
<b>Replacing Toner</b> .....	<b>112</b>
 <b>Clearing Misfeeds</b> .....	<b>113</b>
<b>Changing the Paper Size</b> .....	<b>122</b>
Changing the Paper Size of the Optional A3/11" × 17" Tray Unit (Tray 1).....	122
Changing the Paper Size in Tray 2 or 3 .....	122
Changing the Paper Size of the Large Capacity Tray (Tray 4 and 5) .....	124
 <b>Adding Staples</b> .....	<b>127</b>
Booklet Finisher .....	127
Booklet Finisher (Saddle Stitch).....	129
Finisher 3000B (100-Sheet Staples) .....	131
 <b>Removing Jammed Staples</b> .....	<b>133</b>
Booklet Finisher .....	133
Booklet Finisher (Saddle Stitch).....	134
Finisher 3000B (100-Sheet Staples) .....	136
 <b>Removing Punch Waste</b> .....	<b>138</b>

## 8. Remarks

---

<b>Do's and Don'ts</b> .....	<b>141</b>
<b>Toner</b> .....	<b>142</b>
Handling Toner .....	142
Toner Storage .....	142
Used Toner .....	142
<b>Where to Put Your Machine</b> .....	<b>143</b>
Machine Environment .....	143
Moving .....	144
Power Connection .....	144
Access to the Machine .....	145
<b>Maintaining Your Machine</b> .....	<b>146</b>
Cleaning the Exposure Glass .....	146
Cleaning the Auto Document Feeder .....	146
<b>Other Functions</b> .....	<b>147</b>
Inquiry .....	147
Changing the Display Language .....	148
Counter .....	148

## 9. Security

---

<b>Security</b> .....	<b>149</b>
Primary Security Functions .....	149
Extended Security Function .....	149
Temporarily Disabling Document Security .....	151
<b>Operating Environment and Notes</b> .....	<b>152</b>
Operating Environment .....	152
For Administrator .....	152
For User .....	153

## 10. Specification

---

<b>Main Machine</b> .....	<b>155</b>
Document Server .....	159
Auto Document Feeder .....	160
<b>Options</b> .....	<b>161</b>
Booklet Finisher .....	161
Finisher 3000B (100-Sheet Staples) .....	164
Large Capacity Tray .....	165
Multi Bypass Tray (Tray 7) .....	166
Interposer .....	166
Punch Unit .....	167
<b>Others</b> .....	<b>169</b>
<b>Copy Paper</b> .....	<b>170</b>
Recommended Paper Sizes and Types .....	170
Non-recommended Paper .....	173
Paper Storage .....	174
<b>INDEX</b> .....	<b>175</b>

# Notice

---

## Important

---

Do not make copies of any item for which copying is prohibited by law.

Copying the following items is normally prohibited by local law:

Bank bills, revenue stamps, bonds, stock certificates, bank drafts, checks, passports, driver's licenses.

This machine is equipped with a function that prevents making counterfeit bank bills. Due to this, images similar to bank bills may not be copied properly.

# Copyrights and Trademarks

---

## Trademarks

---

Ethernet is a registered trademark of Xerox Corporation.

Microsoft, Windows and Windows NT are registered trademarks of Microsoft Corporation in the United States and/or other countries.

Novell, NetWare and NDS are registered trademarks of Novell, Inc.

PostScript® is a registered trademark of Adobe Systems Incorporated.

Other product names used herein are for identification purposes only and may be trademarks of their respective companies. We disclaim any and all rights to those marks.

The proper names of the Windows operating systems are as follows:

- The product name of Windows® 95 is Microsoft® Windows 95.
- The product name of Windows® 98 is Microsoft® Windows 98.
- The product name of Windows® Me is Microsoft® Windows Millennium Edition (Windows Me).
- The product names of Windows® XP are as follows:  
Microsoft® Windows® XP Professional  
Microsoft® Windows® XP Home Edition
- The product names of Windows® 2000 are as follows:  
Microsoft® Windows® 2000 Advanced Server  
Microsoft® Windows® 2000 Server  
Microsoft® Windows® 2000 Professional
- The product names of Windows NT® 4.0 are as follows:  
Microsoft® Windows NT® Server 4.0
- Microsoft® Windows NT® Workstation 4.0

---

## Information about Installed Software

---

### expat

---

- The software including controller, etc. (hereinafter “software”) installed on this product uses the expat Version 1.95.2 (hereinafter “expat”) under the conditions mentioned below.
- The product manufacturer provides warranty and support to the software of the product including the expat, and the product manufacturer makes the initial developer and copyright holder of the expat, free from these obligations.
- Information relating to the expat is available at:  
<http://expat.sourceforge.net/>



Copyright (c) 1998, 1999, 2000 Thai Open Source Software Centre, Ltd. and Clark Cooper.

Permission is hereby granted, free of charge, to any person obtaining a copy of this software and associated documentation files (the "Software"), to deal in the Software without restriction, including without limitation the rights to use, copy, modify, merge, publish, distribute, sublicense, and/or sell copies of the Software, and to permit persons to whom the Software is furnished to do so, subject to the following conditions:

The above copyright notice and this permission notice shall be included in all copies or substantial portions of the Software.

THE SOFTWARE IS PROVIDED "AS IS", WITHOUT WARRANTY OF ANY KIND, EXPRESS OR IMPLIED, INCLUDING BUT NOT LIMITED TO THE WARRANTIES OF MERCHANTABILITY, FITNESS FOR A PARTICULAR PURPOSE AND NONINFRINGEMENT. IN NO EVENT SHALL THE AUTHORS OR COPYRIGHT HOLDERS BE LIABLE FOR ANY CLAIM, DAMAGES OR OTHER LIABILITY, WHETHER IN AN ACTION OF CONTRACT, TORT OR OTHERWISE, ARISING FROM, OUT OF OR IN CONNECTION WITH THE SOFTWARE OR THE USE OR OTHER DEALINGS IN THE SOFTWARE.

---

## Authors Name List

---

All product names mentioned herein are trademarks of their respective owners. The following notices are required to satisfy the license terms of the software that we have mentioned in this document:

- This product includes software developed by the University of California, Berkeley and its contributors.
- This product includes software developed by Jonathan R. Stone for the NetBSD Project.
- This product includes software developed by the NetBSD Foundation, Inc. and its contributors.
- This product includes software developed by Manuel Bouyer.
- This product includes software developed by Charles Hannum.
- This product includes software developed by Charles M. Hannum.
- This product includes software developed by Christopher G. Demetriou.
- This product includes software developed by TooLs GmbH.
- This product includes software developed by Terrence R. Lambert.
- This product includes software developed by Adam Glass and Charles Hannum.
- This product includes software developed by Theo de Raadt.
- This product includes software developed by Jonathan Stone and Jason R. Thorpe for the NetBSD Project.
- This product includes software developed by the University of California, Lawrence Berkeley Laboratory and its contributors.

- This product includes software developed by Christos Zoulas.
- This product includes software developed by Christopher G. Demetriou for the NetBSD Project.
- This product includes software developed by Paul Kranenburg.
- This product includes software developed by Adam Glass.
- This product includes software developed by Jonathan Stone.
- This product includes software developed by Jonathan Stone for the NetBSD Project.
- This product includes software developed by Winning Strategies, Inc.
- This product includes software developed by Frank van der Linden for the NetBSD Project.
- This product includes software developed for the NetBSD Project by Frank van der Linden.
- This product includes software developed for the NetBSD Project by Jason R. Thorpe.
- The software was developed by the University of California, Berkeley.
- This product includes software developed by Chris Provenzano, the University of California, Berkeley, and contributors.

# How to Read This Manual

---

## Symbols

---

In this manual, the following symbols are used:

 **WARNING:**

This symbol indicates a potentially hazardous situation that might result in death or serious injury if you use the machine without following the instructions under this symbol. Be sure to read the instructions, all of which are included in the Safety Information section.

 **CAUTION:**

This symbol indicates a potentially hazardous situation that may result in minor or moderate injury or damage; not injury if you use the machine without following the instructions under this symbol. Be sure to read the instructions, all of which are included in the Safety Information section.

\* The statements above are notes for your safety.

 **Important**

If this instruction is not followed, paper might misfeed, originals damaged, or data lost. Be sure to read this.

 **Preparation**

This symbol indicates prior knowledge or preparation is required before operation.

 **Note**

This symbol indicates precautions for operation, or actions to take after misoperation.

 **Limitation**

This symbol indicates numerical limits, functions that cannot be used together, or conditions in which a particular function cannot be used.

 **Reference**

This symbol indicates a reference.

[    ]

Keys that appear on the machine's display panel.

[    ]

Keys built into the machine's control panel.

---

## Notice

---

- The image of the display panel may differ depending on installed options.

# Safety Information

When using this machine, the following safety precautions should always be followed.

---

## Safety During Operation

---

In this manual, the following important symbols are used:

**⚠ WARNING:**  
*Indicates a potentially hazardous situation which, if instructions are not followed, could result in death or serious injury.*

**⚠ CAUTION:**  
*Indicates a potentially hazardous situation which, if instructions are not followed, may result in minor or moderate injury or damage to property.*

---

### **⚠ WARNING:**

---

- **Connect the power cord directly into a wall outlet and never use an extension cord.**
- **Disconnect the power plug (by pulling the plug, not the cable) if the power cable or plug becomes frayed or otherwise damaged.**
- **To avoid hazardous electric shock or laser radiation exposure, do not remove any covers or screws other than those specified in this manual.**
- **Turn off the power and disconnect the power plug (by pulling the plug, not the cable) if any of the following occurs:**
  - **You spill something into the machine.**
  - **You suspect that your machine needs service or repair.**
  - **The external housing of your machine has been damaged.**
- **Do not incinerate spilled or used toner. Toner dust might ignite when exposed to an open flame.**
- **Disposal of toner can take place at our authorized dealer.**
- **Dispose of the used toner bottle in accordance with local regulations.**
- **Do not remove the toner bottle, fuser unit, duplex unit and paper tray all at once. The machine might fall and cause injury. Make sure to first return each component back to its original position before checking other components.**

---

**⚠ CAUTION:**

---

- *Protect the machine from dampness or wet weather, such as rain and snow.*
- *Unplug the power cord from the wall outlet before you move the machine. While moving the machine, you should take care that the power cord will not be damaged under the machine.*
- *When you disconnect the power plug from the wall outlet, always pull the plug (not the cable).*
- *Do not allow paper clips, staples, or other small metallic objects to fall inside the machine.*
- *Keep toner (used or unused) and toner bottle out of the reach of children.*
- *For environmental reasons, do not dispose of the machine or expended supply waste at household waste collection points. Disposal can take place at an authorized dealer.*
- *The inside of the machine could be very hot. Do not touch the parts with a label indicating the “hot surface”. Otherwise, an injury might occur.*
- *Our products are engineered to meet high standards of quality and functionality, and we recommend that you use only the expendable supplies available at an authorized dealer.*

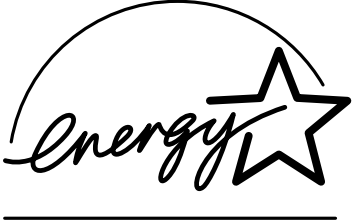

# ENERGY STAR Program

<p>ENERGY STAR®</p> 	<p>As an ENERGY STAR Partner, we have determined that this machine model meets the ENERGY STAR Guidelines for energy efficiency.</p>
---	--

The ENERGY STAR Guidelines intend to establish an international energy-saving system for developing and introducing energy-efficient office equipment to deal with environmental issues, such as global warming.

When a product meets the ENERGY STAR Guidelines for energy efficiency, the Partner shall place the ENERGY STAR logo onto the machine model.

This product was designed to reduce the environmental impact associated with office equipment by means of energy-saving features, such as Low-power mode.

- **Low Power Mode**

This product automatically lowers its power consumption 15 minutes after the last copy or print job has finished. Printing is still possible in Low Power Mode, but if you want to make copies press the **【Energy Saver】** key first.

 **Reference**

For details about how to change the default interval, see p.66 “Energy Saver Timer”.

- **Off Mode (Copier only)**

To conserve energy, this product automatically turns off 90 minutes (Type 2: 120 minutes) after completing the last copy or print job. Printing is still possible in Off Mode, but if you want to make copies, press the operation switch first.

 **Reference**

For details about how to change the default interval, see p.66 “Auto Off Timer”.

- **Sleep Mode (Printer, Scanner installed)**

If the printer features are installed, this product automatically lowers its power consumption even further 90 minutes (Type 2: 120 minutes) after completing the last copy or print job. Printing is still possible in Sleep Mode, but if you want to make copies press the operation switch first.

 **Reference**

For details about how to change the default interval, see p.66 “Auto Off Timer”.

- **Duplex Priority**  
The ENERGY STAR Program recommends use of the Duplex function. By conserving paper, this function has environmental benefits. For applicable machines, duplex function (one-sided original → two-sided copies) is selected when the operation switch or the main power switch is turned on, the **【Energy Saver】** key is pressed, or when the machine resets automatically.

 **Reference**

To change the settings of the Duplex Priority mode, see “Duplex Mode Priority”, *Copy Reference*.

**Specification**

		Copying function only		Multiple function printer with copying, printing, scanning functions	
		Type 1	Type 2	Type 1	Type 2
Low Power Mode	Power consumption	340 W	350 W	345 W	355 W
	Default interval	15 minutes		15 minutes	
	Recovery Time	40 sec.		40 sec.	
Off Mode	Power consumption	6 W		--	
	Default interval	90 minutes	120 minutes	--	
	Recovery Time	360 sec. or less		--	
Sleep Mode	Power consumption	--		50 W	
	Default interval	--		90 minutes	120 minutes
	Recovery Time	--		360 sec. or less	

Duplex Priority	1 Sided → 2 Sided
-----------------	-------------------





❖ **Recycled Paper**

In accordance with the ENERGY STAR Program, we recommend use of environmentally friendly recycled paper. Contact your sales representative for recommended paper.



# Machine Types

This machine comes in two models that differ by copy speed. To determine which model you have, see the machine's inside front cover.

	Type 1	Type 2
Copy speed	90 copies/minute (A4  , 8 1/2" x 11"  )	105 copies/minute (A4  , 8 1/2" x 11"  )



# 1. What You Can Do with This Machine

## Available Functions

You can use this machine as a copier, printer, or scanner. This machine also has a Document Server function which has File Merge, Insert Printing and On Demand Printing functions.

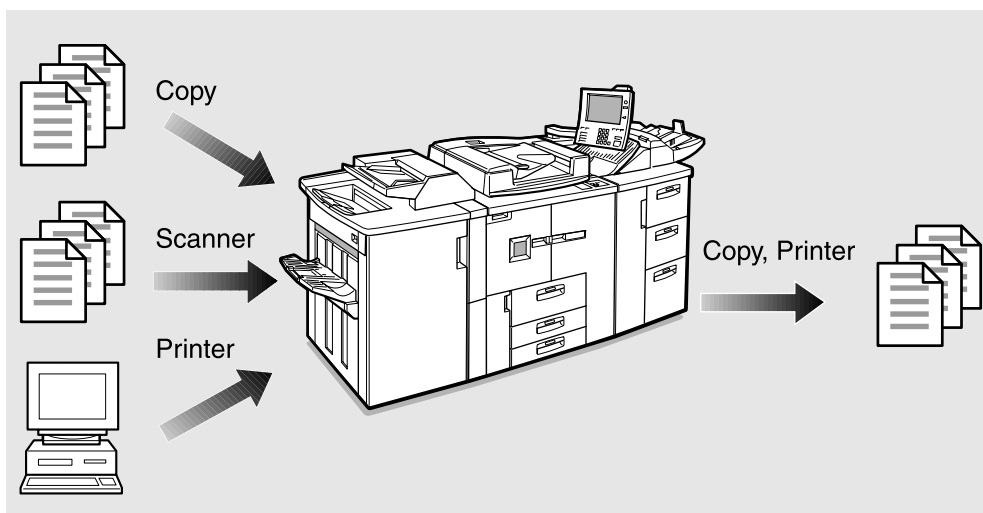

GXMFP22E

---

## Copier Mode

---

In copier mode you can make basic copies and also copy using more sophisticated techniques, such as reduction/enlargement or combining several originals onto one copy. You can install several options for using sort, staple, and saddle stitch functions.

---

## Printer Mode

---

You can print documents under various environments.

---

## Scanner Mode

---

You can use this machine as a network scanner.

It is also possible to e-mail the scanned image as an attached file via the LAN, or Internet.

## Document Server Mode

1

You can save the documents from copy and printer functions to the hard disk. Documents can be printed later, or the machine can be controlled from the computer.

Scanned, copied, or printed documents can be stored on the hard disk, or you can view the document's thumbnails on the computer. The documents can also be downloaded to the computer. <sup>\*1</sup>

<sup>\*1</sup> The stored documents can be viewed, printed, or downloaded using the Web browser. These functions are also available when DeskTopBinder V2 Professional/Lite is installed in the computer.

The machine shown below is equipped with options.

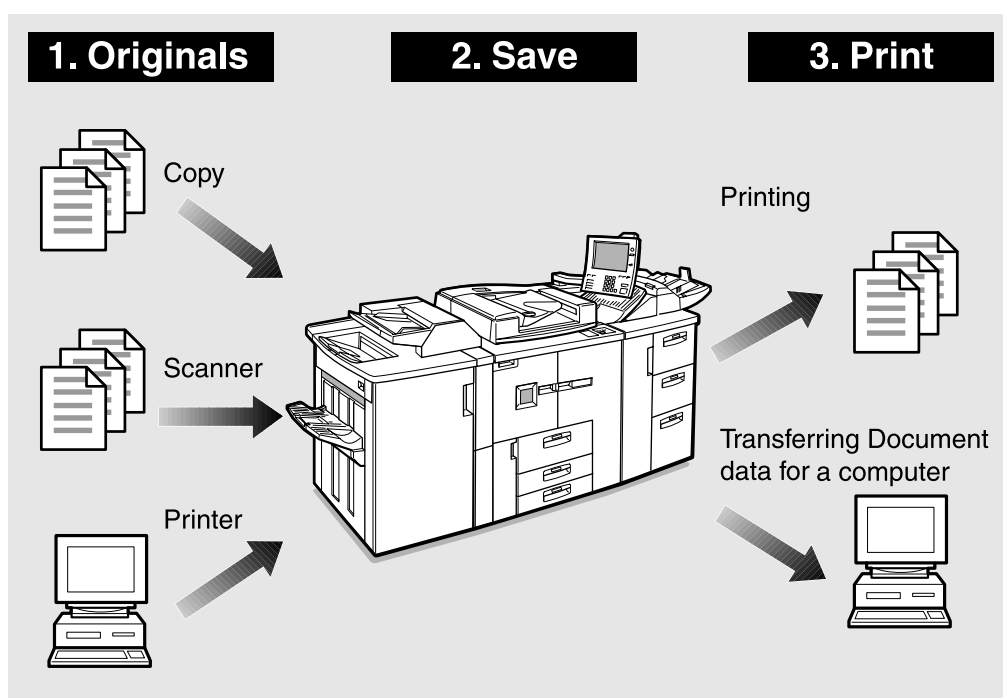

GXD003E

### Note

- You can save the following:
  - Data from documents scanned using the Auto Document Feeder (ADF), and the exposure glass
  - Data sent from a computer

### Important

- Do not turn off the main power switch when the On indicator is lit or blinking. If you turn it off during an operation, the memory or hard disk might be damaged.
- The machine should not be subjected to strong impacts. Strong shocks damage the hard disk or delete stored files.

---

**❖ On Demand Printing**

If you save a document in the Document Server, you can print it out at any time using print settings such as duplex and stapling.

**❖ File Printing**

You can merge and print documents stored in the Document Server, sent from a computer, or scanned.

**❖ Operation from computer**

If you install DeskTopBinder V2 Professional (optional) or DeskTopBinder V2 Lite on the computer, you can check the contents of stored documents, print copies for confirmation and perform other operations. These operations are also possible using the Web browser.

You can also perform operations on data stored in the Document Server from the computer, rather than from the machine.

** Reference**

For more detailed information, see the DeskTopBinder V2 Professional/Lite manuals.

For more information about the Web browser, see p.52 “Viewing Stored Documents on the Web Browser” and *Network Guide*.

## User Management

You can limit users of the machine, and restrict certain functions with user codes.

You can limit the user of the key operator tools to the key operator only. See p.69 “Key Operator Code”.

### Using the User Code

The user is requested to enter a registered user code to operate the machine. You can check machine use by each user.

#### ❖ Managing items

- You can set the functions permitted to each user, as shown below.
- You can output list of usage amounts for each user.

The functions you can restrict are as follows:

Function	Limitation	Usage amount management
Copy	○	○
Printer	○	○/Auto program
Scanner	○	○(manages the number of scannes)
Document Server	○	(depending on the mode to store the document) *1

\*1 When you print the documents by pressing the **【Document Server】** key, the copy counter shows the number of copies for the documents stored in copy and Document Server mode, and the print counter shows the number of documents stored in printer mode.

#### 🔍 Reference

p.69 “User Code Management” and p.75 “User Codes”

## Security Functions

The security functions protect the documents from being copied without permission or unauthorized access through the network. See p.149 “Security”.

#### ❖ Security Functions

- Protecting stored documents (setting passwords)
- Protecting data remaining in memory
- Authenticating administrator (setting the key operator code). See p.69 “Key Operator Code”.

#### ❖ Extended Security Function

By setting a password, documents will be protected from illegitimate accesses. See p.74 “Extended Security”.

# 2. Getting Started

## Guide to Components

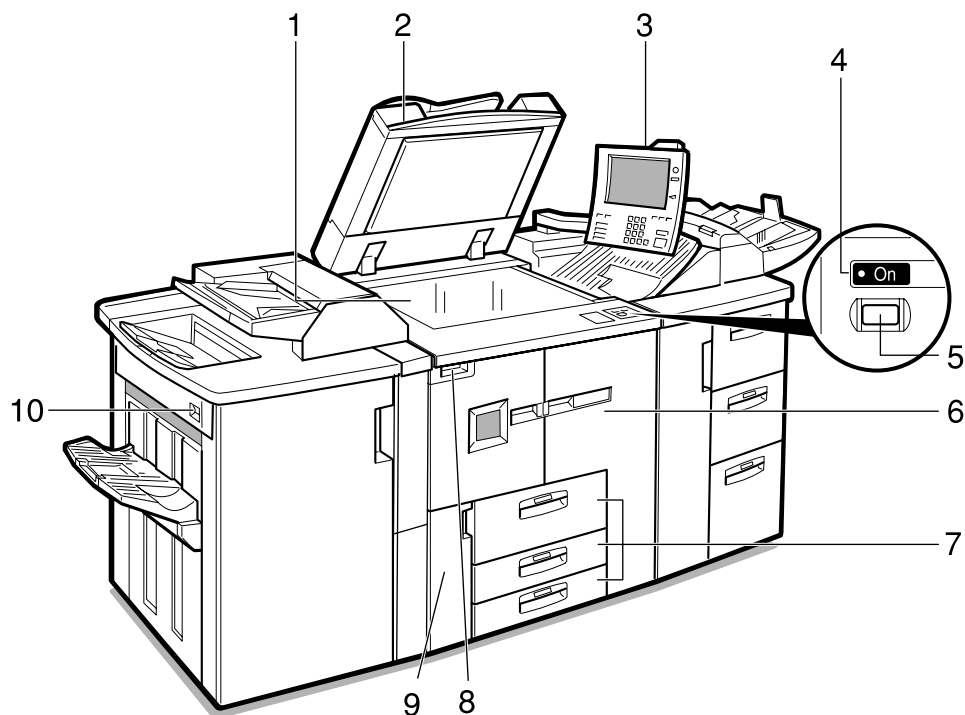

ZJBH030N

### 1. Exposure glass

Place single-page originals here face down for copying.

### 2. Auto Document Feeder (ADF)

The ADF automatically feeds a stack of originals one by one.

### 3. Control panel

See p.20 "Control Panel".

### 4. On indicator

This indicator lights when you press the operation switch.

### 5. Operation switch

Press when you want to use the machine. The On indicator lights when this switch is pressed. See p.24 "Turning On the Power".

### 6. Front cover

Open to remove misfed paper.

### 7. Paper tray

Place copy paper here.

Tray 1 is a tandem tray where paper on the left side automatically moves to the right when paper there has run out.

### 8. Main power switch

Press to turn the main power on or off. We recommend you only turn this switch off when the machine is not going to be used for an extended period of time (e.g. over a vacation). See p.24 "Turning On the Power".

### 9. Toner cover

Open to change the toner bottle.

### 10. Suspend/Resume switch

Press to momentarily stop copying. Pressing again resumes the stopped operation.

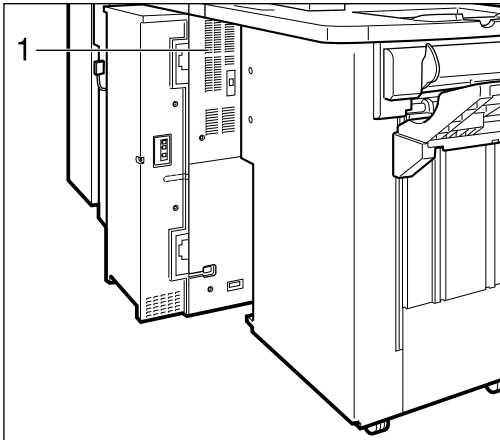

Z1BH040E

### **1. Ventilation hole**

Prevents overheating. Do not obstruct the ventilation hole by placing or leaning an object near it. If the machine overheats, a fault might occur.



# External Options

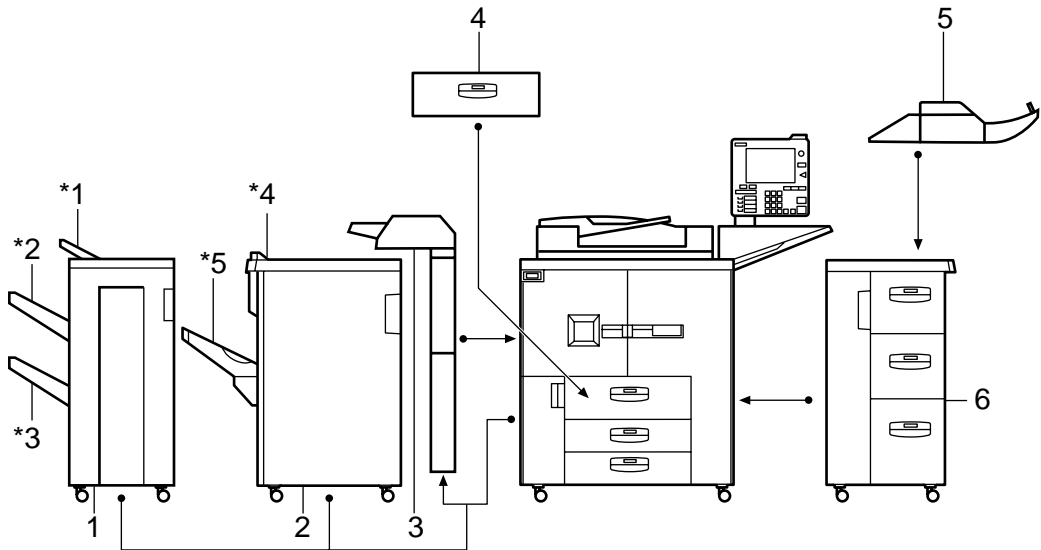

ZJBP560E

## 1. Booklet finisher

Sorts, stacks, staples, and punches copies. The saddle stitch function is also available.

- \*1: Finisher upper tray
- \*2: Finisher shift tray 1
- \*3: Finisher shift tray 2

## 2. Finisher 3000B (100-sheet staples)

Sorts, stacks, staples, and punches copies (optional punch unit required)

- \*4: Finisher upper tray
- \*5: Finisher shift tray

## 3. Interposer

Inserts cover or slip sheets between copies.

## 4. A3/11" × 17" tray unit

Holds A3/11" × 17" size paper.

### Note

- If you install the A3/11" × 17" tray unit on your machine, you cannot use it as a tandem tray.

## 5. Multi bypass tray (Tray 7)

This tray can be used the same way as others.

## 6. Large Capacity Tray (LCT)

Holds 4,550 sheets of paper.

Other options:

- Punch Unit
- Output Jogger

# Control Panel

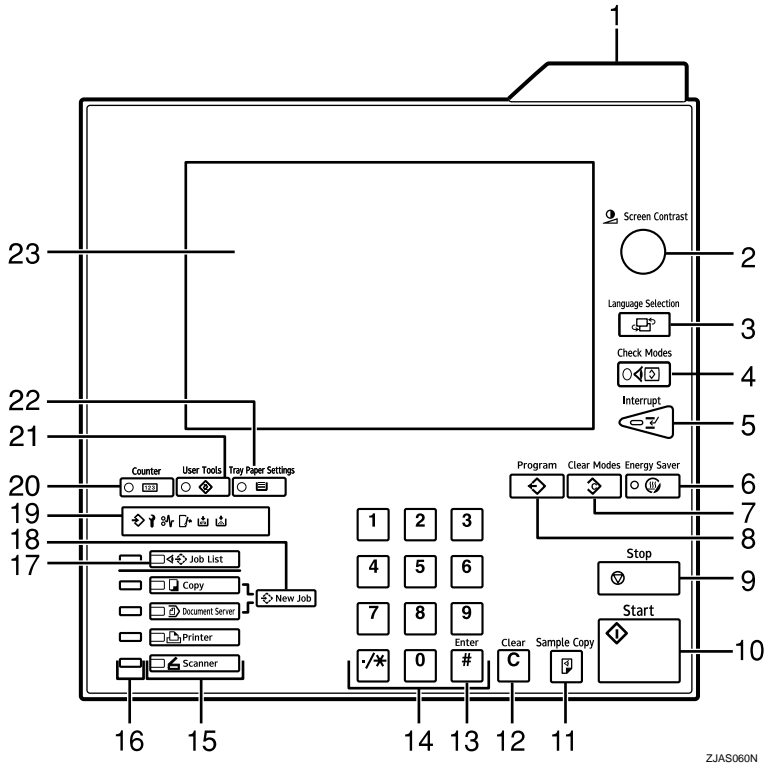

ZJAS060N

## 1. Status indicator

Machine status is described by this indicator. By default, this indicator is turned off. You can select the status indicator lit or not. See p.63 “Status Indicator”.

Off	The main power switch is turned off or ready to make copies.
Flashing green	Scanning originals
Lit green	Copying (ready to scan originals)
Flashing red	Toner has nearly run out.
Lit red	Paper jam or other malfunction

## Note

- ❑ If the status indicator is blinking red, paper jam has occurred in the current copy job. Bring up the current job screen.

## 2. [Screen Contrast] knob

Adjusts display panel brightness.

## 3. [Language Selection] key

Press to change the language of the display.

## 4. [Check Modes] key

Press to check settings.

## 5. [Interrupt] key

Press to make interrupt copies during a copy run. See “Interrupt Copy”, *Copy Reference*.

## 6. [Energy Saver] key

Switch to and from Energy Saver mode. See p.28 “Saving Energy”.

**7. 【Clear Modes】 key**

Press to clear previously entered copy job settings.

**8. 【Program】 key**

Press to register or recall a program.  
See “Program”, *Copy Reference*.

**9. 【Stop】 key**

Press to stop a job in progress such as scanning originals, or printing.

**10. 【Start】 key**

Press to start copying, scanning, or printing documents.

**11. 【Sample Copy】 key**

Press to make a single set of copies or prints before starting a long copy run. By checking a sample set and making necessary changes to image quality settings before starting a multiple copy run, you can save time and paper. See p.46 “Sample copy”.

**12. 【Clear】 key**

Press to delete a number entered.

**13. 【#】 key**

Press to enter a value or confirm a setting.

**14. Number keys**

Use to enter the number of copies.

**15. Function keys**

Press the appropriate key to select one of the functions.

- Copier
- Document Server
- Printer
- Scanner

**16. Function status indicators**

These show the status of the functions.

- Green: active.
- Red: interrupted. Press the function key to change the display, and then follow the displayed instructions.

**17. 【Job List】 key**

Shows the job list for a copy job or jobs stored in the Document Server.

**18. 【New Job】 key**



Use this key to set up the next copy job while a copy job or storing data in the Document Server is in progress.

**19. Indicators**



Show errors and machine status.



: Data In indicator. See p.32 “Multi-Access”.

: Service Call indicator

: Misfeed indicator. See p.113 “ Clearing Misfeeds”.

: Open Cover indicator

: Add Staple indicator. See p.127 “ Adding Staples”.

: Add Toner indicator. See p.111 “ Adding Toner”.

**20. 【Counter】 key**

Press to see the total number of copies made. See p.148 “Counter”.

**21. 【User Tools】 key**

Press to access the User Tools menu where you can customize default settings. See p.57 “User Tools (System Settings)”.

**22. 【Tray Paper Settings】 key**

Specify the paper tray settings for delivery. See p.93 “Paper Tray Settings”.

**23. Display panel**

Shows operation status, error messages, and function menus. See p.23 “Display Panel”.

 **Note**

- You can adjust the angle of the control panel.

2

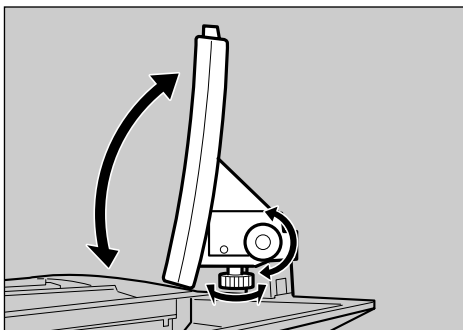

ZAJS070E

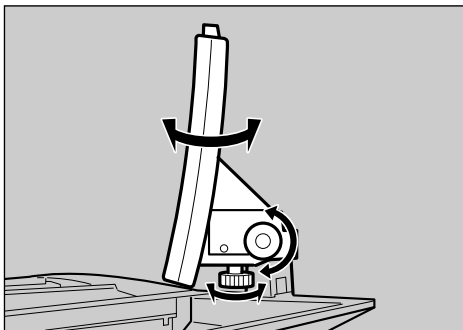

ZAJS080E

## Display Panel

The display panel shows machine status, error messages, and function menus.

### Important

- A force or impact of more than 30 N (about 3 kgf) will damage the display panel.

The default is to display the screen for copying when you first turn the power on. The function items displayed serve as selector keys. You can select or specify an item by lightly pressing them.

When you select or specify an item on the display panel, it is highlighted like this: **Full Size**. Keys appearing as **OK** cannot be used.

### ◆ Initial Copy Display

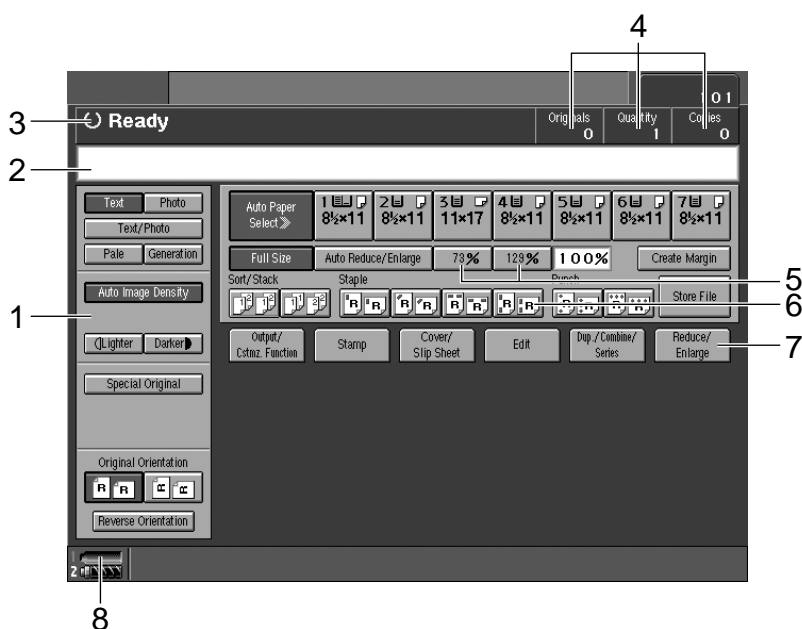

1. Original mode, Image Density and Special Original mode.

2. Operational messages.

3. Operational status.

4. The number of originals, copies, and printed pages.

5. You can register up to two frequently used reduce/enlarge ratios other than the fixed reduce/enlarge ratios.

6. Sort, Stack, Staple or Punch mode.

7. Functions you can select. Press an item to bring up its function menu e.g. press [Reduce/Enlarge] to bring up the Reduce/Enlarge menu.

8. This indicator shows when toner has nearly run out.

# Turning On the Power

This machine has two power switches.

❖ **Operation switch (right front side of the exposure glass)**

Press to activate the machine. Once the machine has warmed up, you can make copies.

❖ **Main power switch (left side of the machine)**

When the machine will not be used for an extended period of time, turn off the main power switch.

 **Note**

- ❑ This machine automatically goes into Low Power mode, or turns itself off if you do not use it for a specified period of time. See p.66 “Auto Off Timer” and p.66 “Energy Saver Timer”.

---

## Turning On the Main Power

---

**1** Make sure the power cord is firmly plugged into the wall outlet.

**2** Turn on the main power switch.

Make sure that the main power indicator lights up.

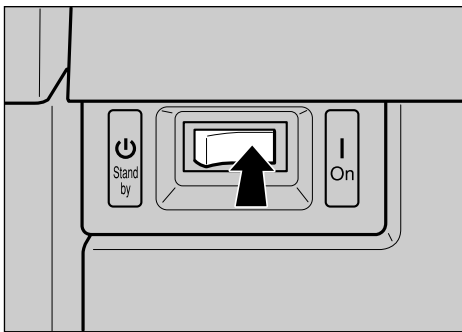

ZAKH010N

 **Important**

- ❑ Do not turn off the main power immediately after switching it on. Doing so may result in damage to the hard disk or memory, leading to malfunction.

---

## Turning On the Power

---

- 1 Press the operation switch to make the On indicator light up.

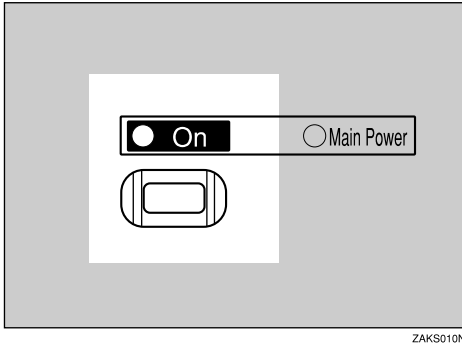

 **Note**

- If the power is not turned on when the operation switch is pressed, check the main power switch is on. If off, turn it on.

---

## Turning Off the Power

---

- 1 Press the operation switch to make the On indicator go out.

 **Note**

- Even if you press the operation switch, the indicator remains lit and blinks in the following cases:
  - When communication with external equipment is in progress.
  - When the hard disk is active.

---

## Turning Off the Main Power

---

 **Important**

- Do not turn off the main power switch when the On indicator is lit or blinking. Doing so may result in damage to the hard disk or memory, leading to malfunction.
- Pull out the power cord after turning off the main power switch. Not doing so may result in damage to the hard disk or memory, leading to malfunction.

- 1 Make sure the On indicator is unlit.

- 2 Turn off the main power switch.

Make sure that the main power indicator goes out.





# 3. Combined Function Operations

## Changing Modes

### Note

- ❑ You cannot switch modes when accessing user tools or during interrupt copying.
- ❑ The default display is the screen for copying, which appears when you turn the power on. You can change this setting. For details about such settings, see p.62 “Function Priority”.

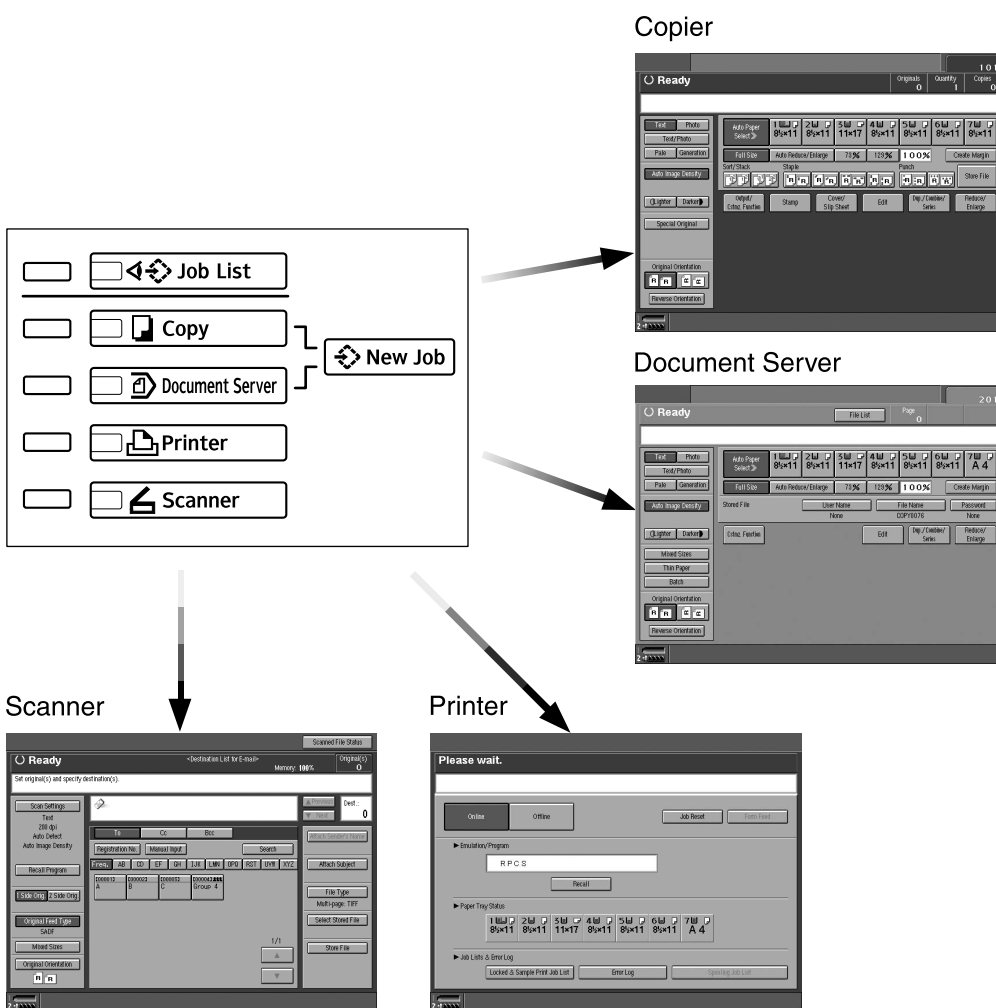

ZJBH490N

---

## Saving Energy

---

 **Low Power Mode**

If you do not operate the machine for a specified period of time after an operation, or when you press the **【Energy Saver】** key, the display disappears and the machine goes into Low Power mode. When you press the **【Energy Saver】** key again, the machine returns to the “Ready” status. In Low Power mode, the machine uses less electricity.

 **Note**

- You can change the Panel Off Timer. See p.67 “Panel Off Timer”.

 **System Reset**

The machine automatically returns to its initial condition when a job is finished, after a specified period of time. This function is called “System Reset”.

 **Note**

- You can change the System Reset Timer. See p.67 “System Auto Reset Timer”.

 **Auto Off**

The machine automatically turns itself off after a job is finished, after a specified period of time. This function is called “Auto Off”.

 **Note**

- You can change the Auto Off Timer. See p.66 “Auto Off Timer”.
- Auto Off Timer will not operate in the following cases:
  - When a warning message appears
  - When the service call message appears
  - When paper is jammed
  - When the cover is open
  - When the “Adding Toner” message appears
  - When toner is being added
  - When the User Tools or Counter screen is displayed
  - When fixed warm-up is in progress
  - When printer or other functions are operating

- When operations have been interrupted during printing
- When the Data In indicator is on or blinking
- When the sample print or confidential print screen is displayed

---

## Job List

---

In the Job List, you can check and delete the contents of jobs in the print queue and jobs currently printing.

### Note

- In the Job List, jobs reserved using copy mode and Document Server mode are displayed. When **[Print Priority]** in System Settings is set to **[Job Order]**, jobs reserved using copy mode, printer mode, Document Server mode, Web browser, DeskTopBinder V2 Professional (optional) or DeskTopBinder V2 Lite are displayed.
- You can set the length of interval between the end of a job and the start of a new job with the User Tools. See p.65 “Time Interval between Printing Jobs”. Even if you have set the interval, you can start printing a job before the set time has elapsed by pressing **[Start Printing]**.

### Reference

For setting the time interval, see p.65 “Time Interval between Printing Jobs”. For setting Web browser, see Web browser's Help menu, and for setting DeskTopBinder V2 Professional (optional) or DeskTopBinder V2 Lite, see the manuals.

---

## Checking the list

---

- 1** Press the **[Job List]** key.

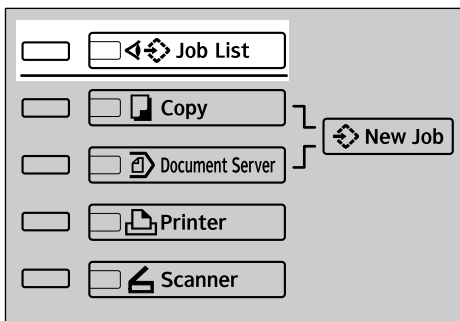

The job list appears.

**2** Select the number of the job you want to check.

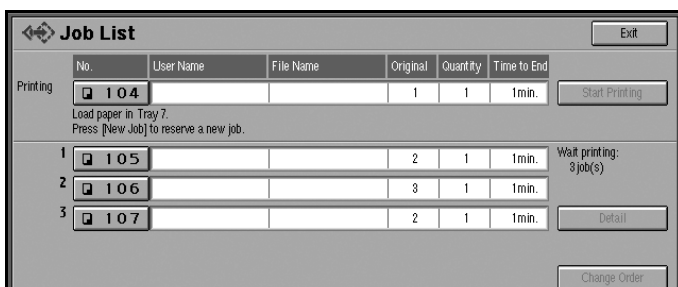

**3**

The icons below show the operation mode of stored documents.

Job printed using copy mode.	Job printed using printer mode.	Job printed using Document Server mode.	Job printed using DeskTop-Binder V2 Professional/Lite	Job printed using Web browser.

**Note**

- If more than ten jobs are registered, press [**▲Previous**] or [**▼Next**] to scroll the screen.

**3** Press [**Detail**].

**4** Check the contents of the list.

**5** Press [**OK**].

The display returns to the job list menu.

---

### Changing the order of jobs

---

**1** Press the [**Job List**] key.

**2** Select the number of the job you want to change the order.

**Note**

- You can change the order of jobs only in standby mode.

**3** Press [**Change Order**].

**4** Change the order using [**▲Previous**] or [**▼Next**].

**5** Press [**OK**].

---

## Deleting jobs

---

**1** Press the **[Job List]** key.

The job list appears.

**2** Select the number of the job to be deleted.

 **Note**

You can delete a job during printing.

**3** Press **[Delete Job]**.

**4** Press **[Yes]**.

The display returns to the job list menu.

# Multi-Access

You can carry out another job using a different function while the current job is being performed. Performing multiple functions simultaneously like this is called "Multi-Access".

This allows you to handle jobs efficiently, regardless of how the machine is being used. For example:

- While making copies, you can scan documents to store in the Document Server.
- While printing documents saved in the Document Server, the machine can receive print data.
- While printing print data, you can set copying operations.

 **Note**

- You can set the priority of functions, see p.63 "Print Priority". As default, the "Display Mode" is set to first priority.

---

 **Sample operations**

The tables on the following pages show sample operations for when "Print Priority" is set to "Interleave". See p.63 "Print Priority".

△: Simultaneous operations are available.

●: Operation is enabled when the relevant function key is pressed and remote switching (of the scanner) is done.

○: Operation is enabled when the **【Interrupt】** key is pressed to interrupt the current operation.

→: Operation is performed automatically once the current operation ends.

×: The operation must be started once the current operation ends. (Simultaneous operations are not available.)

Mode after you select		Copy			Interrupt Copying		Printer			Scanner		Document Server		DeskTopBinder V2 Professional/Lite	
							Print								
Mode before you select		Operations for copying	Stapling	Sort	Operations for copying	Copying	Data reception	Printing	Stapling	Operations for scanning	Scanning	Operations for document Server	Scanning a document to Store in Document Server	Printing from Document Server	Printing from Document Server
Copy	Operations for copying	×	×	×	○	○	△	△	△	●	●	●	●	●	△
	Stapling	△ <sup>*1</sup>	→ <sup>*1</sup>	→ <sup>*1</sup>	○	○ <sup>*4</sup>	△	△	→	●	● <sup>*2</sup>	●	● <sup>*2</sup>	△ <sup>*3</sup>	△ <sup>*3</sup>
	Sort	△ <sup>*1</sup>	→ <sup>*1</sup>	→ <sup>*1</sup>	○	○	△	△	△	●	● <sup>*2</sup>	●	● <sup>*2</sup>	△	△
Interrupt Copying	Operations for copying	○	○	○	×	×	△	△	△	×	×	×	×	×	△
	Copying	○	○	○	×	×	△	→	→	×	×	×	×	×	→
Printer	Data reception	△	△	△	△	△	→	→	→	△	△	△	△	△	△
	Sort print	△	△	△	○	○	△	→	→	△	△	△	△	△	△
	Stapling	△	→	△	○	○ <sup>*4</sup>	△	→	→	△	△	△	△	△ <sup>*3</sup>	△ <sup>*3</sup>
Scanner	Operations for scanning	●	●	●	○	○	△	△	△	×	×	●	●	●	△
	Scanning	×	×	×	×	×	△	△	△	×	×	×	×	×	△
Document Server	Operations for Document Server	●	●	●	○	○	△	△	△	●	●	×	×	×	△
	Scanning a document to store in Document Server	●	×	×	○	○	△	△	△	●	×	×	×	×	△
	Printing from Document Server	●	△ <sup>*3</sup>	△	○	○	△	△	△	△	△	△ <sup>*5</sup>	△ <sup>*5</sup>	△ <sup>*5</sup>	△

Mode after you select		Copy			Interrupt Copying		Printer		Scanner		Document Server		DeskTopBinder V2 Professional/Lite		
							Print								
Mode before you select		Operations for copying	Stapling	Sort	Operations for copying	Copying	Data reception	Printing	Stapling	Operations for scanning	Scanning	Operations for document Server	Scanning a document to Store in Document Server	Printing from Document Server	Printing from Document Server
DeskTopBinder V2 Professional/Lite	Printing from Document Server	△	△ <sup>*3</sup>	△	△	△	△	△	△	△	△	△	△	△	×
Web Browser	Printing from Document Server	△	△ <sup>*3</sup>	△	△	△	△	△	△	△	△	△	△	△	×

\*1 Simultaneous operations are only available after the preceding job documents are all scanned and **[New Job]** appears.  
 \*2 You can scan a document after the preceding job documents are all scanned.  
 \*3 During stapling, printing automatically starts after the current job.  
 \*4 Stapling is not available.  
 \*5 Simultaneous operations are possible when you press **[New Job]**.

 **Note**

Stapling cannot be used at the same time for multiple functions.





# 4. Document Server

## Relationship between Document Server and Other Functions

The following table describes the relationship between the Document Server and other machine functions.

Function name	From where documents are stored	Displaying a list <sup>*1</sup>	Printing stored documents <sup>*2</sup>	Sending document
Copier	Copier/Document Server	Enabled	Enabled	Disabled
Printer	Personal computer	Enabled	Enabled	Disabled
Scanner	Scanner	Disabled <sup>*3</sup>	Disabled	Enabled <sup>*4</sup>

<sup>\*1</sup> You can also display stored documents from a Web browser. See p.52 “Viewing Stored Documents on the Web Browser”.

<sup>\*2</sup> You can print stored documents from a Web browser. See p.44 “Printing Stored Documents”. If DeskTopBinder V2 Professional (optional) or DeskTopBinder V2 Lite is installed on your computer, all the stored documents can also be printed from your computer.

<sup>\*3</sup> You can display stored documents from scanner mode. See “Viewing a List of Stored Files”, *Scanner Reference*.

<sup>\*4</sup> You can e-mail stored documents from scanner mode. See “Using E-mail with the Document Server”, *Scanner Reference*.

# Document Server Display

## ❖ Document Server Main Display

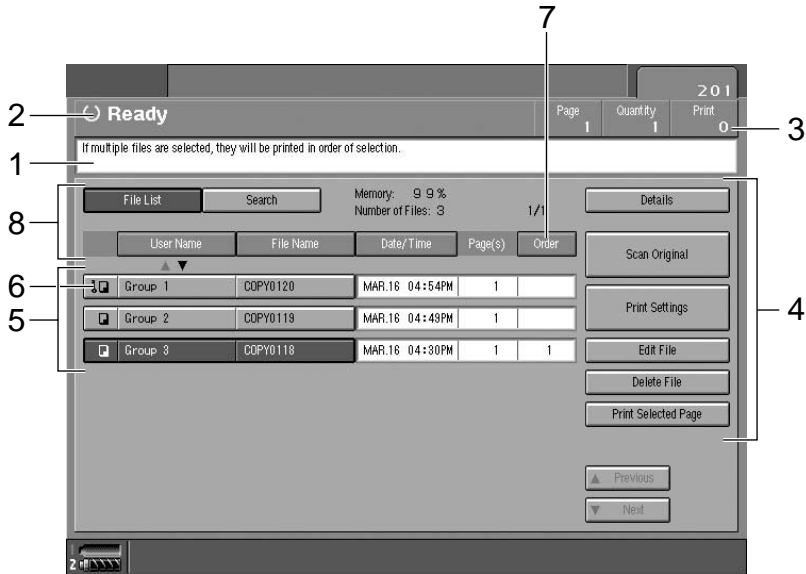

ZJBS100N

1. Operating status and messages.
2. The title of the currently selected screen.
3. The numbers of originals, copies, and printed pages.
4. The operation keys.
5. The stored operation mode.

6. Icons to show the operation mode. **1** is appeared when setting the password.
7. Pressing [Order] displays the documents in the selected order.
8. Press a desired key, and the documents are sorted in the order of the pressed key.

The icons below show the operation mode when documents stored in the Document Server.

Function	Copier	Printer	Scanner
Icon			--

# Using the Document Server

---

## Storing Data

---

### ❖ File Name

Saved documents will automatically be named "COPY0001", "COPY0002". You can change assigned file names.

### ❖ User Name

You can register user names to distinguish the person or department that saved the documents. To assign a user name, you can register it using the name assigned to the user code or entering the name.

#### Reference

For more information about user codes, see p.75 "User Codes".

### ❖ Password

You can set a password for saved documents, and use it to prevent others printing them. When a password is set for the documents,  appears against the document name.

#### Reference

To store documents in a mode other than Document Server mode, see References for the respective functions.

### Important

- Data stored in the machine might be lost if some kind of failure occurs. The manufacturer shall not be responsible for any damage that might result from loss of data. For long-term storage of data, we recommend use of DeskTopBinder V2 Lite or DeskTopBinder V2 Professional (optional). For more information, contact your local manufacture.

### Note

- Data stored in the Document Server is set to be deleted after 3 days (72 hours) by the factory default setting. You can specify the period after which the stored data is deleted automatically. See p.73 "Auto Delete File" .

## 1 Press the **[Document Server]** key.

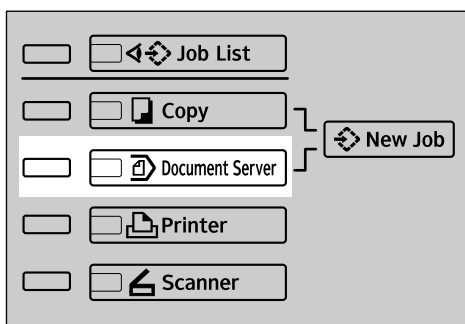

ZJAS343N

## 2 Press **[Scan Original]** when the list appears.

4

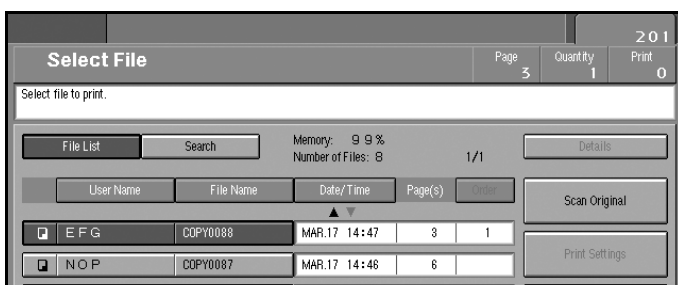

## 3 Enter a file name, user name, or password if necessary.

### Note

- If you do not register a file name, one is automatically assigned.

### Reference

- p.39 "To register or change a user name"
- p.40 "To change a file name"
- p.41 "To set or change a password"

## 4 Place originals.

### Reference

For more information about types of originals that can be placed and how to place them, see *Copy Reference*.

## 5 Make any desired settings.

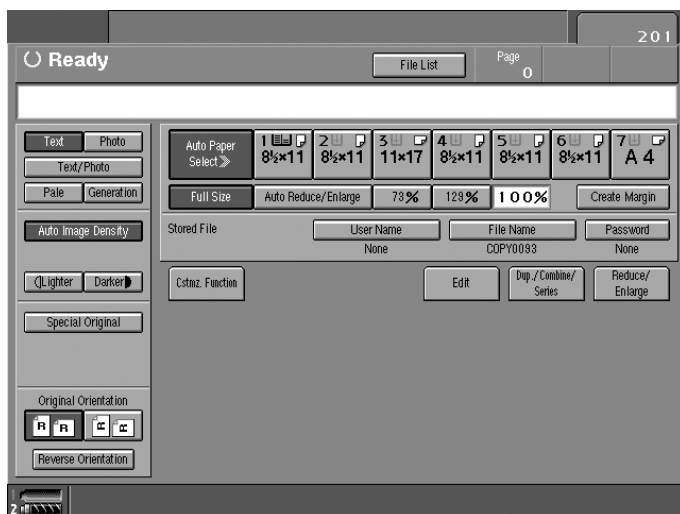

### Reference

For setting of scanning that you can use, see p.53 “Functions Available in Document Server Mode”.

For settings of scanning, see *Copy Reference*.

## 6 Press the **[Start]** key.

The document is saved in the Document Server.

### Note

- To stop scanning, press the **[Stop]** key. To resume a paused scanning job, press **[No]** in the confirmation dialog box. To delete saved images and cancel the job, press **[Yes]**.
- When a password has been set for the document, enter it, and then press **[OK]**.
- Saved documents appear on the “Select Files to Print” display. If it is not displayed, press **[Scanning Finished]**.

---

## To register or change a user name

---

### 1 Display the “Stored File” display.

### 2 Press **[User Name]**.

If user names have already been registered, the “Change User Name” display appears. To use an unregistered user name, press **[Non-programmed Name]**.

### Reference

p.75 “User Codes”

---

If registered user names are used

---

- 1 Select a registered user name from the list, and then press [OK].

To change your user name to an unregistered user name, proceed to the next step.

 **Reference**

p.75 "Registering a New User Code"

---

If there are no registered user names

---

- 1 Enter the new user name, and then press [OK].
- 2 Enter the user name, and then press [OK].

 **Note**

You can type up to 20 characters for user name.

 **Reference**

p.91 "Entering Text"

---

If no registered user names are used

---

- 1 Press [Non-programmed Name].
- 2 Enter the new user name, and then press [OK].

 **Reference**

p.91 "Entering Text"

---

To change a file name

---

- 1 Bring up the "Stored File" display.
- 2 Press [File Name].

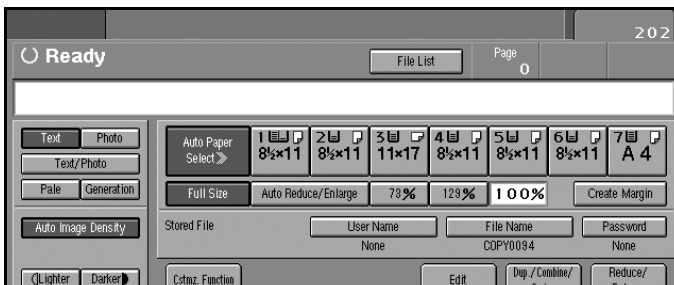

The "Change File Name" display appears.

- 3 Press [Delete All] to delete the previous file name.

 **Note**

You can also use [Backspace] to delete unnecessary characters.

#### 4 Enter a new file name, and then press [OK].

##### Note

- A string of up to 20 characters can be entered as a file name. Note that only 16 characters of each file name will appear in the document list.

##### Reference

p.91 “Entering Text”

### To set or change a password

#### 1 Bring up the “Stored File” display.

#### 2 Press [Password].

#### 3 Enter the password using the number keys (four-digits), and then press [OK] or the [#] key.

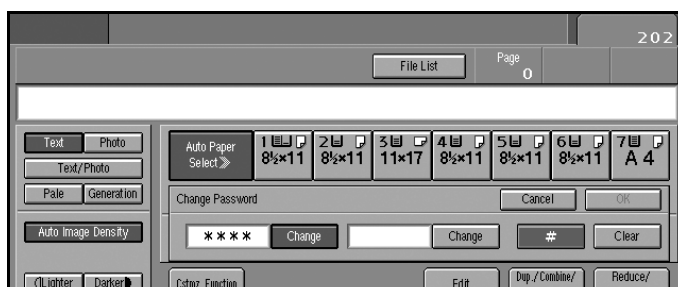

### Changing the File Name, User Name, or Password

#### 1 Press the [Document Server] key.

#### 2 Select the document for which the user name, file name, or password is to be changed.

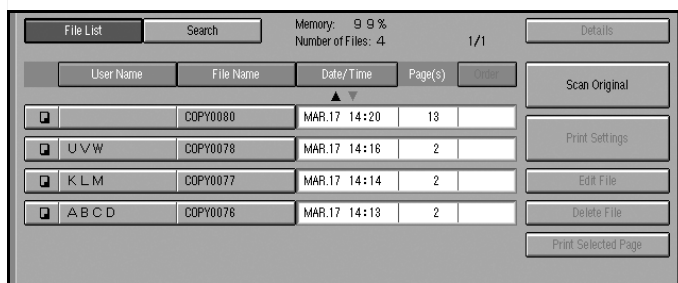

##### Note

- If a password has already been set for the document, enter it, and then press [OK].

**3** Press [Edit File].

**4** Press [Change File Name], [Change User Name], or [Change Password].

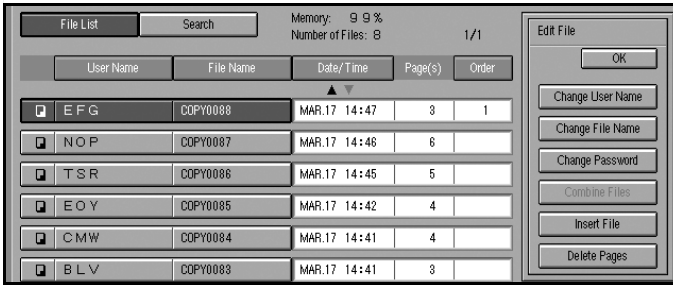

**5** Enter the new file name, user name, or password using the letter keys or number keys, and then press [OK].

**Reference**

- p.39 "To register or change a user name"
- p.40 "To change a file name"
- p.41 "To set or change a password"

**6** Press [OK].

---

## To Check Details of Stored Documents

---

**1** Press the [Document Server] key.

**2** Select the document for which you want to display detailed information.

**Note**

- If a password has been set for the document, enter it, and then press [OK].

**3** Press [Detail].

Detailed information about the document is displayed.

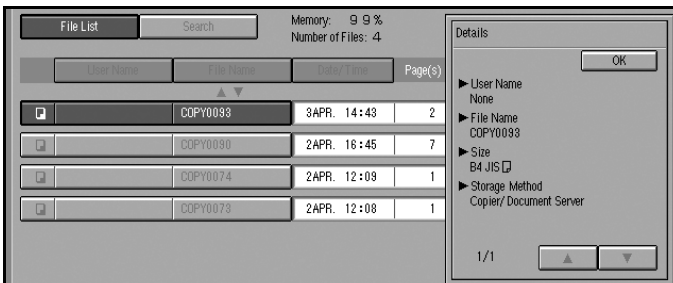

**Note**

- If you have selected several documents, use [▲] and [▼] to view the details of each.
- Press [OK]. The "Select Files" display appears.



---

## Searching for Stored Documents

---

You can use either **[Search by User Name]** or **[Search by File Name]** to search for documents stored on the Document Server. You can also list stored documents in the order you prefer.

### Note

- If you install DeskTopBinder V2 Professional (optional) or DeskTopBinder V2 Lite on the computer, you can search and rearrange documents from the computer.

### Reference

For more detailed information, see the DeskTopBinder V2 Professional/Lite manuals.

---

### To search by user name

---

**1** Press the **[Document Server]** key.

**2** Press **[Search]**.

**3** Press **[Search by User Name]**.

### Note

- If you also press **[Search by File Name]**, you can enter the file name simultaneously.

**4** To specify a registered user name, select the user name from the displayed list, and then press **[OK]**.

### Note

- To specify an unregistered user name, follow the procedures below.

**5** To specify an unregistered user name, press **[Non-programmed Name]**, enter the name, and then press **[OK]**.

### Reference

p.91 "Entering Text"

**6** Press **[OK]**.

Only files beginning with the name entered appear in the "Select Files to Print" display.

### Note

- To display all files saved in the Document Server, press **[File List]**.

---

## To search by file name

---

**1** Press the **[Document Server]** key.

**2** Press **[Search]**.

**3** Press **[Search by File Name]**.

 **Note**

- If you also press **[Search by User Name]**, you can enter the user name simultaneously.

**4** Enter the file name, and then press **[OK]**.

**5** Press **[OK]**.

Only files beginning with the name entered appear in the “Select Files” display.

 **Reference**

p.91 “Entering Text”

 **Note**

- To display all files saved in the Document Server, press **[File List]**.

---

## Printing Stored Documents

---

You can print documents stored in the Document Server with the procedures below.

 **Note**

- You can print stored documents from a network computer with the Web browser. For details about how to start the Web browser, see *Network Guide*.

---

## Printing from the list

---

**1** Press the **[Document Server]** key.

**2** Select the document to be printed.

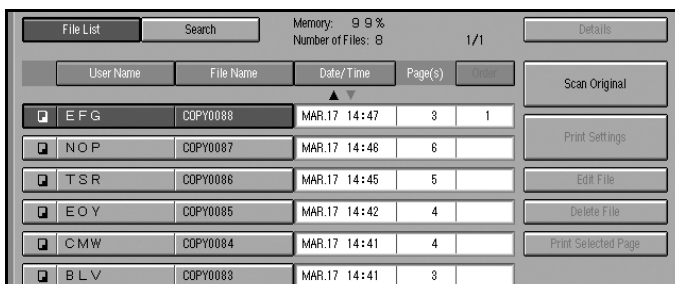

 **Note**

- If a password has been set for the document, enter the password, and then press **[OK]**.
- You can select up to 30 documents.
- If sizes, resolutions or quality of selected documents are not the same, the documents may not be printed.
- If you want to change the order of printing, cancel the selection, and select documents in the desired order.
- If you press **[Delete File]**, selection of all documents will be canceled.
- When multiple documents are printed at the same time, print settings made for the document printed first are applied to all other documents.

**3** Enter the required number of copies using the number key. **Note**

- Up to 9999 can be entered.

**4** Press the **[Start]** key.

---

**Change the print settings when printing**

---

**1** Select the document to be printed.**2** Press **[Print Settings]**.

The “Print Settings” display appears. User names, file names, and print order of documents appear.

 **Note**

- The print settings made for printing in copier or printer mode are stored by pressing **[Save Print Settings]**, and applied to the next printing.
- When multiple documents are printed at the same time, print settings made for the document printed first are applied to all other documents.
- When you press **[Save Print Settings]**, the changed print settings and the number of print are stored.
- If you print more than one set using the sort function, you can check the print result by printing out only the first set. See p.46 “Sample copy”.
- If you select multiple files, you can confirm file names or print order you selected in step **1** by scrolling through the list with **[▼]** and **[▲]**.
- Press **[File List]** to return to the “File List” display.

**3** Enter the required number of copies using the number keys. **Note**

- Up to 9999 can be entered.

**4** Press the **[Start]** key.

The machine starts printing.

---

### Stopping printing

---

**1** Press the **[Stop]** key.

**2** Press **[Stop]**.

---

### Changing the number of copies during printing

---

 **Note**

- The number of copies can only be changed when the sort function is selected in print settings.

**1** Press the **[Stop]** key.

**2** Press **[Change Quantity]**.

**3** Use the number keys to enter a new number of copies.

**4** Press the **[#]** key.

**5** Press **[Continue]**.

Printing restarts.

---

### Preset copy

---

You can set the next job while printing a document stored in the Document Server.

 **Reference**

For details about settings, see “Preset Job”, *Copy Reference*.

---

### Sample copy

---

If you print multiple sets using the sort function, you can check the print order or print settings are correct by printing out only the first set using the **[Sample Copy]** key.

 **Note**

- This function can be used only when the sort function is selected.

## 1 Select the document to be printed.

### Note

- If a password has been set for the document, enter it, and then press **[OK]**.
- You can search for a document using **[Search by User Name]** or **[Search by File Name]**. See p.43 "Searching for Stored Documents".
- You can sort document names in the list by user name, file name, or date. To sort the documents, press **[User Name]**, **[File Name]**, or **[Date/Time]**.
- To cancel a document selection, press the highlighted document again.

## 2 Check the print settings.

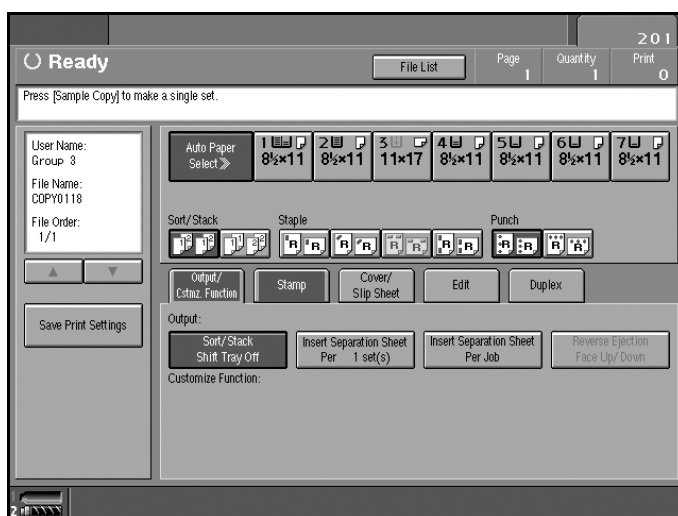

## 3 Press the **[Sample Copy]** key.

The first set is printed.

## 4 Press **[Print]**.

Printing restarts.

### Note

- Press **[Suspend]** to cancel printing and return to the Print Settings menu where you can change the settings.

---

## Print Selected Pages

---

You can print the first page or selected pages of the document selected in the Select Files to Print display to check content.

### **1** Select the document to be printed.

#### **Note**

- If a password has been set for the document, enter it, and then press **[OK]**.
- You can search for a document using **[Search by User Name]** or **[Search by File Name]**. See p.43 “Searching for Stored Documents”.
- You can sort document names in the list by user name, file name, or date. To sort documents, press **[User Name]**, **[File Name]**, or **[Date/Time]**.
- To cancel a document selection, press the highlighted document again.

### **2** Press **[Print Selected Page]**.

---

#### Printing the first page

---

You can print only the first page of the selected document to check content. If two or more documents are selected, the first page of each is printed.

#### **1** Press **[1st Page Only]**.

---

#### Printing the specified pages

---

You can print specified pages of the selected document to check content.

#### **Limitation**

- You cannot print specified pages if two or more documents are selected.

#### **1** Press **[Specify Page]**.

#### **2** Enter the first page number to be printed using the number keys.

#### **3** Press **[Page to Page]**.

#### **4** Enter the last page number to be printed using the number keys.

### **3** Press the **[Start]** key.

## Edit File

### Combining Files

You can combine two or more files stored in the Document Server. Follow the procedure below to combine files.

#### Note

- You cannot recover the original files from the new file.
- You cannot combine files if they are currently being used by another function.
- You can combine up to 30 files.

**1** Press the **[Document Server]** key.

**2** Select documents you want to combine.

#### Note

- If the password has been set for the document, enter it, and then press **[OK]**.
- The files are combined in the order of being selected.
- The print settings for the file selected first are stored.

**3** Press **[Edit File]**.

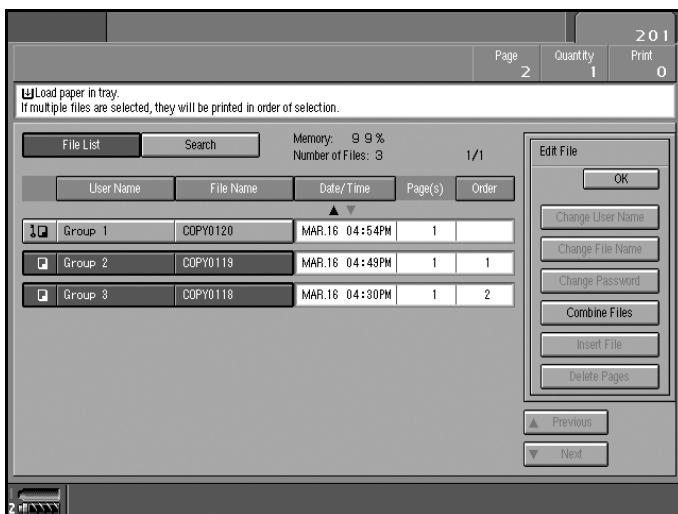

**4** Press **[Combine Files]**.

**5** Enter the new file name.

#### Note

- For setting the file name, see p.40 "To change a file name".
- If you do not set the file name, the name of the file selected first will be the name of the combined file.

**6** Press **[OK]**.

---

## Inserting Documents

---

You can insert a file into files already stored in the Document Server. Follow the procedure below to insert a file.

 **Note**

- You cannot recover the original file from the new file.
- You cannot insert files into a file that is currently being used by another function.

**1** Press the **[Document Server]** key.

**2** Select the document to be inserted in.

 **Note**

- If a password has been set for the document, enter it, and then press **[OK]**.

**3** Press **[Edit File]**.

**4** Press **[Insert File]**.

**5** Select the document you want to insert into.

**6** Enter the page number to insert the file using the number keys.

**7** Press **[Before Specified Page]** or **[After Specified Page]**.

**8** Press **[OK]**.

---

## Deleting Pages

---

Follow the procedure below to delete pages from a file stored on the Document Server.

 **Preparation**

To check the page numbers, print the file. See p.44 "Printing Stored Documents".

**1** Press the **[Document Server]** key.

**2** Select the document containing the pages you want to delete.

 **Note**

- If a password has been set for the document, enter it, and then press **[OK]**.

**3** Press **[Edit File]**.

**4** Press **[Delete Pages]**.

**5** Enter the number of the page you want to delete using the number keys.



**6** If you want to delete a series of pages, press **[Page to Page]**, and then enter the number of the last page you want to delete.

 **Note**

- If you want to delete only one page, proceed to step **7**.
- If you enter the last page number, the whole file will be deleted.

**7** Press **[OK]**.

**8** Press **[Yes]** in the confirmation dialog box.

---

## Deleting Stored Documents

---

 **Important**

- You can store up to 3,000 documents in the Document Server. No more documents can be stored when there are 3,000 documents in the Document Server. You should delete unnecessary documents.

 **Note**

- You can delete all stored documents at once with User Tools. See p.73 “Delete All Files”.
- You can delete stored documents from a network computer using the Web browser. For details about how to start the Web browser, see *Network Guide*.

**1** Press the **[Document Server]** key.

**2** Select the document to be deleted.

 **Note**

- If a password has been set for the document, enter it, and then press **[OK]**.
- You can delete multiple documents at once. See p.73 “Delete All Files”.
- You can search for a document by user name or file name, using **[Search by User Name]** or **[Search by File Name]** respectively. See p.43 “Searching for Stored Documents”.
- You can sort document names in the list by the user name, file name, or date. To sort documents, press **[User Name]**, **[File Name]**, or **[Date/Time]**.
- If you cannot find the document using its name, you can print the first page of a document to check its contents. See p.48 “Print Selected Pages”.
- Press the selected line again to cancel the print job.

**3** Press **[Delete File]**.

**4** Press **[Yes]** to delete the document.

---

## Viewing Stored Documents on the Web Browser

---

### Reference

For settings of the Web Browser, see *Network Guide*. For details about the Web Browser, see Help menu.

**1** Start the Web browser.

**2** Enter “http:// (the IP address of this machine) /” in the [Address] box.

The top page appears on the Web browser.

**3** Click [Document Server].

The Document Server File List appears.

### Note

The Document Server File List can be displayed without showing thumbnails. Click [Details].

**4** Click the Properties icon of the document you want to check.

The information of that document appears.

**5** Confirm the content of the document.

### Note

To enlarge the preview of the document, click [Preview].

---

## Downloading Stored Documents

---

### Note

An option is required to download documents stored in copier or printer mode.

**1** Start the Web browser.

**2** Enter “http:// (the IP address of this machine) /” in the [Address] box.

The top page appears on the Web browser.

**3** Click [Document Server].

The Document Server File List appears.

**4** Click the Properties icon of the document you want to download.

### Note

The Document Server File List can be displayed as thumbnails. Click [Thumbnail].

**5** Select PDF, JPEG, or Multi-pageTIFF as the file format by clicking one of the icons.

# Functions Available in Document Server Mode

Functions that you can use during scanning or printing documents in Document Server mode are as shown below.

Function	Key Display		Web Browser
	Scanning	Printing	
Batch Mode	○	×	—
Mixed Sizes	○	×	—
Custom Size Originals	○	×	—
SADF Mode	○	×	—
Thin Mode	○	×	—
Face Up	○	×	—
Auto Image Density	○	×	—
Dark Background	○	×	—
Manual Image Density	○	×	—
Original Type Setting	○	×	—
Number of Sets	×	○	○
Program	×	×	—
Auto Paper Select	○	○	○
Manual Paper Select	○	○	○
Reduce/Enlarge	○	×	—
Create Margin	○	×	—
Zoom	○	×	—
Auto Reduce/Enlarge	○	×	—
Size Magnification	○	×	—
Directional Magnification (%)	○	×	—
Directional Size Magnification (inch)	○	×	—
Sort	×	○	○
Stack	×	○	○
Staple	×	○	○
Punch	×	○	○
1 Sided → 2 Sided/2 Sided → 2 Sided	○	×	—
1 Sided Combine	○	×	—
2 Sided Combine	○	×	—

Function	Key Display		Web Browser
	Scanning	Printing	
Book → 1 Sided	×	○	○
Book → 2 Sided	×	○	○
2 Sided → 1 Sided	×	○	○
1 Sided → Booklet 2 Sided → Booklet	×	○	○
1 Sided → Magazine 2 Sided → Magazine	×	○	○
Mix 1 & 2 Sided	×	×	—
Specify Pages to Print in Duplex	×	○	○
Repeat	×	×	—
Double Copy	×	○	○
Centering	○	○	○
Cornering	×	○	○
Scanning Position	○	×	—
Border Erase	○	×	—
Center Erase	○	×	—
Center/Border Erase	○	×	—
3 Edges Full Bleed	×	○	○
Inside Erase	○	×	—
Outside Erase	○	×	—
Margin Adjustment	×	○	○
Background Numbering	×	○	○
Preset Stamp	×	○	○
User Stamp	×	○	○
Date Stamp	×	○	○
Stamp Text	×	○	○
Page Numbering	×	○	○
Covers	×	○	○
Designate	×	○	○
Chapter	×	○	○
Designation Sheet Copy	×	○	○
Blank Slip Sheets	×	○	○
Slip Sheets	×	○	○

 **Note**

- ❑ “Cornering” and “Specify Pages to Print in Duplex” are enabled only in Document Server mode.
- ❑ You can select the printing position from eight types using “Cornering” when you print a document stored in the Document Server.
- ❑ You can print the specified pages of documents stored in the Document Server using “Specify Pages to Print in Duplex”.

# Settings for the Document Server

❖ **Copier/Document Server Features (See p.62 “General Features”, Copy Reference.)**

	Items	Default
General Features	Function: Scanning	--
	Function: Printing	--

❖ **System Settings (See p.62 “General Features”, p.66 “Timer Setting”, and p.69 “Key Operator Tools”).**

	Items	Default
General Features	Warm Up Notice	ON
	Copy Count Display	Up
	Output: Document Server	OFF
	Paper Tray Priority: Copier	Tray 1
Timer Setting	Copier /Document Server Auto Reset Timer	60 seconds
Key Operator Tools	Auto Delete File	After 3 days
	Delete All Files	--
	Password Management for Stored Files	Do not Unlock

4

# 5. User Tools (System Settings)

## User Tools Menu (System Settings)

● These items must be set to use the function. Be sure to set them before using the corresponding function.

○ These items must be set if required.

### ❖ General Features (See p.62 “General Features”.)

	Default	Copier/ Document Server	Printer	Scanner
Panel Tone	Medium	○	○	○
Warm Up Notice	ON	○		
Copy Count Display	Up	○		
Function Priority	Copier	○	○	○
Print Priority	Display Mode	○	○	
Function Reset Timer	3 seconds	○	○	
Interleave Print	10 sheet(s)			
Status Indicator	ON			
Screen Color Setting	B&G			
Output Tray Setting	According to Function Setting	○		
Output: Copier	*Not Registered	○		
Output: Document Server	*Not Registered			
Output: Printer	*Not Registered		○	
Paper Tray Priority: Copier	Tray1			
Paper Tray Priority: Printer	Tray1			
Job List Display Time	15 seconds	○		
Time Interval between Printing Jobs	3 seconds			

	Default	Copier/ Document Server	Printer	Scanner
ADF Original Table Elevation	When original is Set	<input type="radio"/>		
ADF Feed Speed	Normal			
Optimum for Thick Paper	Off			
<F/F4> Size Setting	8 <sup>1</sup> / <sub>2</sub> × 13			

❖ **Timer Setting (See p.66 “Timer Setting”).**

	Default	Copier	Printer	Scanner
Auto Off Timer	90 minutes (Type 2: 120 minutes)	<input type="radio"/>		
Energy Saver Timer	15 minutes	<input type="radio"/>		
Panel Off Timer	1 minute	<input type="radio"/>	<input type="radio"/>	<input type="radio"/>
System Auto Reset Timer	60 seconds	<input type="radio"/>	<input type="radio"/>	<input type="radio"/>
Copier/ Document Server Auto Reset Timer	60 seconds	<input type="radio"/>		
Scanner Auto Reset Timer	60 seconds			<input type="radio"/>
Set Date	--	<input checked="" type="radio"/>		<input type="radio"/>
Set Time	--	<input checked="" type="radio"/>		<input type="radio"/>
Weekly Timer Code	Off	<input type="radio"/>		
Weekly Timer: Monday – Sunday	--	<input type="radio"/>	<input type="radio"/>	<input type="radio"/>

❖ **Interface Settings (See Network Guide.)**

❖ **File Transfer (See Network Guide.)**



❖ **Key Operator Tools (See p.69 “Key Operator Tools”).**

	Default	Copier	Printer	Scanner
User Code Management	OFF ( [Auto Program] for printer mode only)	<input type="radio"/>	<input type="radio"/>	<input type="radio"/>
Key Counter Management	OFF	<input type="radio"/>	<input type="radio"/>	<input type="radio"/>
External change Unit Management	--			
Key Operator Code	OFF	<input type="radio"/>	<input type="radio"/>	<input type="radio"/>
Display User Code	Do not Display			
Display/Print Counter	--	<input type="radio"/>	<input type="radio"/>	<input type="radio"/>
Display/Clear/Print Counter per User Code	--	<input type="radio"/>	<input type="radio"/>	
Print Address Book	--			
Address Book Management	--	<input type="radio"/>	<input type="radio"/>	<input type="radio"/>
Address Book: Program/Change/Delete Group	--			<input type="radio"/>
Address Book: Change Order	--			<input type="radio"/>
Address Book: Edit Title	--	<input type="radio"/>	<input type="radio"/>	<input type="radio"/>
Select Title	Title 1	<input type="radio"/>	<input type="radio"/>	<input type="radio"/>
Auto Delete File	After 3 days	<input type="radio"/>	<input type="radio"/>	<input type="radio"/>
Delete All Files	--	<input type="radio"/>	<input type="radio"/>	<input type="radio"/>
Password Management for Stored Files	Do not Unlock	<input type="radio"/>	<input type="radio"/>	<input type="radio"/>
Key Operator's E-mail Address	--			<input type="radio"/>
Machine E-mail Address	--			
AOF (Always ON)	ON			
Extended Security	Off			

# Accessing User Tools (System Settings)

This section is for key operators in charge of this machine. You can change or set default settings.

 **Note**

- Setting operations with the user tools are done in a completely different mode from that of ordinary operations. Be sure to return to the normal operating mode when you finish making settings. See p.61 “Exiting User Tools”.
- Any changes you make with User Tools remain in effect even if the main power switch or operation switch is turned off, or the **[Clear Modes]** key is pressed.

---

## Changing the Default

---

5

 **Note**

- When the key operator code has been set, the key operator code input screen appears when you attempt to change the initial settings. Enter the registered key operator code. For details about key operator codes, see p.69 “Key Operator Tools”.

**1** Press the **[User Tools]** key.

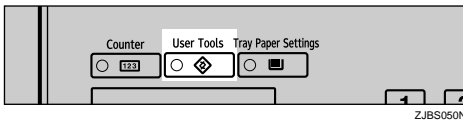

User Tools Main Menu is displayed.

**2** Press **[System Settings]**.

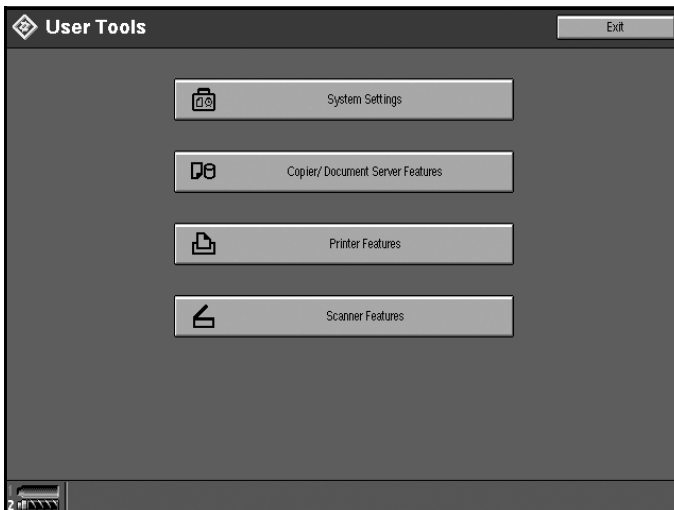

The System Settings screen is displayed.

**3** Select an item you want to set.

 **Reference**

p.57 “User Tools Menu (System Settings)”

**4** Change the default following the instructions on the display, and then press [OK].

---

## Exiting User Tools

---

**1** After changing User Tools settings, press [Exit] on the User Tools Main Menu.

User Tool changes are complete, and the machine is ready to copy.

 **Note**

You can also exit User Tools by pressing the **【User Tools】** key.

# Settings You Can Change with User Tools

 **Reference**

To access User Tools, see p.60 “Accessing User Tools (System Settings)”.

---

## General Features

---

❖ **Panel Tone**

The beeper (key tone) sounds when a key is pressed.

 **Note**

Default: *Medium*

❖ **Warm Up Notice (Copier/Document Server)**

Specify whether or not the beeper sounds when the machine becomes ready for copying after Low Power mode is deactivated, or the power is turned on.

 **Note**

Default: *ON*

If the “Panel Tone” setting is “OFF”, the beeper does not sound, whatever the “Warm Up Notice” setting.

❖ **Copy Count Display (Copier/Document Server)**

The copy counter can be set to show the number of copies made (count up) or the number of copies remaining (count down).

 **Note**

Default: *Up (count up)*

❖ **Function Priority**

You can specify the mode to be displayed immediately after the operation switch or System Reset mode is turned on.

 **Note**

Default: *Copier*

## ❖ Print Priority

Print priority is given to the mode selected.

### Reference

p.32 “Multi-Access”

### Note

Default: *Display mode*

When the optional booklet finisher, or Finisher 3000B (100-Sheet Staples) is installed, you can specify an output tray to which documents are delivered. For more information about how to specify an output tray for each function, see the following descriptions:

- p.64 “Output: Copier”
- p.65 “Output: Document Server”
- p.65 “Output: Printer”

## ❖ Function Reset Timer

You can set the length of time the machine waits before changing modes when using the multi-access function (see p.32 “Multi-Access”). This is useful if you make many copies and you have to change the settings for each copy. If you set a large value, you can prevent jobs from other functions interrupting the copy job.

### Note

Default: *3 seconds*

The Function Reset Timer setting is ignored if “Interleave” is set for “Print Priority” (see p.63 “Print Priority”).

When you select “Set Time”, enter the time (3–30 seconds in 1 second increments) using the number keys.

## ❖ Interleave Print

You can set the timing for functions to switch when **[Print Priority]** has been set to **[Interleave]**.

### Note

Default: *10 sheets*

Depending on printing time, set values may change.

The timing for functions can be set from 1 to 20 sheets.

## ❖ Status Indicator

You can specify whether the status indicator shows the machine status or not.

### Note

Default: *ON*

❖ **Screen Color Setting**

You can select the screen color among from four types: Blue & Green Type, Blue & Purple Type, Green Type, or Gray Type.

 **Note**

- Default: *Blue & Green Type*

❖ **Output Tray Setting**

You can set the way or timing for switching the output tray.

- **Output Tray**

You can set the way for switching the output tray from According to Function Setting or Auto Change.

-  **Note**

- Default: *According to Function Setting*
  - Auto Change can be used when Print Priority is set to Job Order. See p.63 "Print Priority".

- **Change Output Tray**

You can set the timing for switching the output tray, when the Output Tray has been set to Auto Change, from When Tray is Full or Per Job.

-  **Note**

- Default: *When Tray is Full*

❖ **Output: Copier**

You can specify a tray to which documents are delivered.

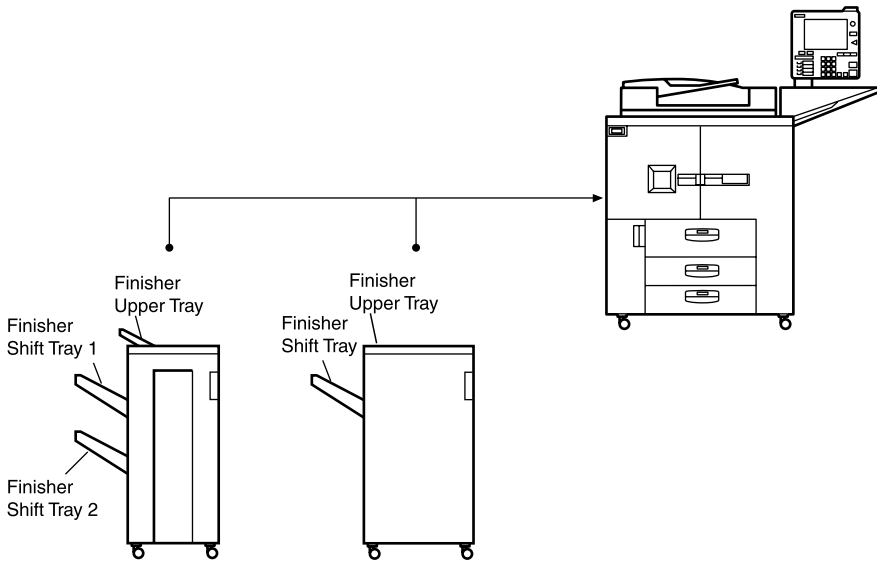

 **Note**

- Default: *Not Registered*
- The default settings of the tray set as output tray may vary depending on the installed optional finisher.

**❖ Output: Document Server**

You can specify a tray to which documents are delivered.

** Note**

- Default: *Not Registered*
- For details about output trays, see p.64 “Output: Copier”.
- The default of the output tray may vary depending on the installed optional finisher.

**❖ Output: Printer**

You can specify a tray to which documents are delivered.

** Note**

- Default: *Not Registered*
- The output trays set on the printer driver have priority over the output tray specified above.
- The default of the output tray may vary depending on the installed optional finisher.

**❖ Paper Tray Priority: Copier (Copier/Document Server)**

You can specify the paper tray for delivery.

** Note**

- Default: *Tray 1*

**❖ Paper Tray Priority: Printer (Printer)**

You can specify the paper tray for delivery.

** Note**

- Default: *Tray 1*

**❖ Job List Display Time**

You can set the length of time the job list screen is displayed before automatically returning to the default screen.

** Note**

- Default: *15 seconds*
- When you select “On”, enter the time from 10 to 999 seconds in 1 second increments using the number keys.

**❖ Time Interval between Printing Jobs**

You can set the length of interval between the end of a job and the start of a new job.

** Note**

- Default: *3 seconds*
- If you select “Set Time”, enter the time, 0 - 999 seconds (in 1 second increments), using the number keys.

**❖ ADF Original Table Elevation**

You can set the timing for elevating the ADF original table.

** Note**

Default: *When original is set*

**❖ ADF Feed Speed**

When you use thick paper, you can slow down the printing speed to avoid fusing the image by selecting [**slow**].

** Note**

Default: *Normal*

**❖ Optimum for Thick Paper**

You can set the optimum for thick paper to On or Off.

**❖ <F/F4> Size Setting**

You can specify the paper size for F/F4.

** Note**

Default:  $8\frac{1}{2} \times 13$

5

---

## Timer Setting

---

**❖ Auto Off Timer**

The machine turns off automatically to conserve energy after a specified amount of time has passed following job completion. This function is called “Auto Off”. The machine status after Auto Off operation is called “Off mode” or “Sleep mode”.

For Auto Off Timer, specify the time to elapse before Auto Off is activated.

** Note**

Default: *90 minutes* (Type 2: 120 minutes)

Auto Off Timer function will not operate if an error message appears.

The time can be set from 10 seconds to 240 minutes using the number keys.

**❖ Energy Saver Timer**

Set the amount of time the machine waits before switching to Low Power mode after copying has finished or the last operation is performed.

** Note**

Default: *15 minutes*

The time can be set from 10 seconds to 240 minutes using the number keys.



**❖ Panel Off Timer**

Set the amount of time the machine waits before switching the panel off after copying has finished or the last operation is performed.

** Note**

- Default: *1 minute*
- The warm up time for making a copy from standby mode is 5 seconds.
- The interval time can be set from 10 seconds to 240 minutes using the number keys.

**❖ System Auto Reset Timer**

The System Auto Reset Timer setting automatically switches to the screen of the function set in Function Priority. This happens if no operations are performed or when an interrupted job is cleared. This setting sets the system reset interval. See p.62 "Function Priority".

** Note**

- Default: *60 seconds*
- The time can be set from 10 to 999 seconds in 1 second increments using the number keys.

**❖ Copier/Document Server Auto Reset Timer (Copier/Document Server)**

Specifies the time to elapse before copier and Document Server functions are reset.

** Note**

- Default: *60 seconds*
- If "OFF" is selected, the machine will not automatically switch to the user code entry screen, and you will not be able to restrict who uses the machine.
- The time can be set from 10 to 999 seconds in 1 second increments using the number keys.

**❖ Scanner Auto Reset Timer (Scanner)**

Specifies the time to elapse before the scanner function is reset.

** Note**

- Default: *60 seconds*
- If "OFF" is selected, the machine will not automatically switch to the user code entry screen, and you will not be able to limit who uses the machine.
- The time can be set from 10 to 999 seconds in 1 second increments using the number keys.

**❖ Set Date**

Set the date for the copier's internal clock.

** Note**

- To change between year, month, and day, press [←] and [→].
- Enter the year, month, and day using the number keys.

**❖ Set Time**

Set the time for the copier's internal clock.

** Note**

- Enter the time in 24-hour system (in 1 second increments).
- To change between hours, minutes, and seconds, press [←] and [→].
- Enter the hours, minutes, and seconds using the number keys.

**❖ Weekly Timer Code**

Set an eight-digit code to turn the main power on and off at the time set in "Weekly Timer".

** Note**

- Default: *OFF*
- If "ON" is selected, enter the Weekly Time Code with number keys. Not doing so may result in the machine being disabled, even if the power is turned on.

**❖ Weekly Timer: Monday-Sunday**

Set the power on and off timer using the number keys.

** Note**

- Enter the time in 24-hour system (in 1 second increments).
- Enter the hour and minute using the number keys.

## Key Operator Tools

The key operator must set the following items. For settings or more information, contact the key operator.

Recommended to use Key Operator Code. See p.69 “Key Operator Code”.

### ❖ User Code Management

Allows you to restrict who uses the machine by setting codes for users. User codes must be registered for user code management. See p.75 “User Codes”.

#### Note

- Default: *Copier/OFF, Document Server/OFF, Printer/Auto Program, Scanner/OFF*
- By using “Auto Program” for the printer, you can keep a print log for each user code entered from the driver.

### ❖ Key Counter Management

Use the key counter to specify whether users are restricted or not.

#### Note

- Default: *Copier/OFF, Document Server/OFF, Printer/OFF, Scanner/OFF*

### ❖ External Charge Unit Management

You can set whether to use the key operator code.

#### Note

- Default: *Copier/Off, Document Server/Off, Scanner/Off, Printer/Off*

### ❖ Key Operator Code

If you want to use the key operator code, register the code.

#### Note

- Default: *OFF*
- If you select ON, enter the key operator code (max. eight-digits) using the number keys, and then select Part of Initial Settings, All Initial Settings or All Functions to set the access limit.
  - If you selected Part of Initial Settings
 

A key operator code is only required for the Timer Setting, Key Operator Tools initial settings. MENU PROTECT will be set for CHANGE/CONTROL in the printer initial settings. If you set MENU PROTECT, you can set the key operator code in a part of the printer initial settings. See “Printer Features Parameters”, *Printer Reference 2*.
  - If you selected All Initial Settings
 

A key operator code will be required to access all the items in the System Settings, Copier/Document Server functions, Printer functions, and Scanner functions.

- If you selected All Functions  
A key operator code is required for all functions. When you turn the power on, you have to enter the key operator code to use the machine.
- If you set the key operator code, you will need to enter it to access the Key Operator Code screen.

#### ❖ Display User Code

You can have entered user codes displayed.

##### Note

- Default: *Do not display*
- When Do not display is selected, the entered user code will not appear but “✖” appears instead.
- When Display is selected, the entered user code will appear. In copy mode, user codes appear on the Job List screen.

#### ❖ Display/Print Counter

Allows you to view and print the various counters.

- Display/Print Counter  
Displays counters for each functions (Total, Copier, Printer, A3/DLT, Duplex, Staple, GPC, GPC Printer).
- Print Counter List  
Prints out a list of counters for each functions.
- To print the counter list
  - ① Press the **[User Tools]** key.
  - ② Press **[System Settings]**.
  - ③ Press **[Key Operator Tools]**.
  - ④ Press **[Display/Print Counter]**.
  - ⑤ Press **[Print Counter List]**.
  - ⑥ Press the **[Start]** key.
  - ⑦ Press **[Exit]**.

#### ❖ Display/Clear/Print Counter per User Code

Allows you to view and print the various counters accessed with user codes and to set the values to 0.

##### Note

- Press **[▲Previous]** and **[▼Next]** to show all counters.
  - Print Counter for All User Codes  
Prints the counter values for all user codes.
  - Clear Counter for All User Codes  
Sets the counter value for all user codes to 0.
  - Print Counter per User Code  
Prints the counter values for each user code.
  - Clear Counter per User Code  
Sets the counter value for each user code to 0.

## Reference

For details about the Print List for Each User Code, see p.79 “Printing the Counter for Each User Code”.

### ❖ Print Address Book

Allows you to print the address book. You can select an item to print Print in Title 1 Order, Print in Title 2 Order, Print in Title 3 Order, or Print Group Dial List.

### ❖ Address Book Management

Adds, changes, or deletes user codes (max. eight-digits). For details about operations, see p.75 “User Codes”.

#### Note

- You can register up to 2,000 user names.
- You can register up to 500 user codes.
- You can also register user codes from SmartNetMonitor for Admin.
- Even if you change the user codes, the counter values are not cleared.
- If you clear a user code, the counter values associated with it are also automatically cleared.
  - **[Program/Change]**  
This registers new user codes. You can register and change user codes and user names.
  - **[User Name]**  
User (destination) name, key display, registration number, title selection
  - **[User Code]**  
User code, available functions
  - **[E-mail Address]**  
E-mail address, register as a sender, sender's password, enter password
  - **[Group]**  
Switch title, registration number
  - **[Delete]**  
Deletes a user.

### ❖ Address Book: Program/Change/Delete Group

You can register multiple e-mail addresses in a group. Then you can easily control the registered e-mail address for each group. For details about registering e-mail destinations, see p.86 “Registering E-mail Destinations to a Group”.

- **[Program/Change]**  
This registers new groups, or changes a group name, key display, title selection, programmed user, or registration number.
- **[Delete]**  
Deletes a group.

### ❖ Address Book: Change Order

Changes the order of registered users (destinations).

#### Note

You can rearrange the order of items on the same page, but you cannot move the items to another page. For example, you cannot move an item from “PLANNING” ([OPQ]) to “DAILY” ([CD]).

- ① Press the **[User Tools]** key.
- ② Press **[System Settings]**.
- ③ Press **[Key Operator Tools]**.
- ④ Press **[Address Book:Change Order]**.
- ⑤ Press the user (destination) key to be moved.

#### Note

- You can select a user using the number keys.
- ⑥ Press the user (destination) key in the place you want to move it to. The user (destination) selected in step ⑤ moves to the place selected in step ⑥, and the keys for all other users will shift too.

#### Note

- You can select a user with the number keys.

### ❖ Address Book: Edit Title

You can edit the title to search for a desired user easily.

- ① Press the **[User Tools]** key.
- ② Press **[System Settings]**.
- ③ Press **[Key Operator Tools]**.
- ④ Press **[Address Book: Edit Title]**.
- ⑤ Press the title key to be changed.
- ⑥ Enter the new name, and then press **[OK]**.
- ⑦ Press **[OK]**.

### ❖ Select Title

Specifies the title to select a user.

#### Note

- Default: *Title 1*

### ❖ Auto Delete File

Specifies whether documents stored in the Document Server are deleted or not after a specified period of time.

#### Note

- Default: *Yes After 3 day (s)*
- If you select "On", documents stored after this setting will be deleted.
- If you select "Off", documents will not be deleted automatically. A message "Are you sure you want to delete all stored files?" appears.
- If you select "On", enter a number of days in the range of 1 - 180.
- The default is 3 days, which means documents will be deleted three days (72 hours) after they are stored.

### ❖ Delete All Files

All documents stored in the Document Server will be deleted.

#### Note

- Even if a password has been set, all documents will be deleted.
- A confirmation dialog box will appear. To delete all documents, select [Yes].

### ❖ Password Management For Stored Files

- Unlocking a locked document  
When a document is locked due to entering a wrong password, this function unlocks the document to allow access.
- Temporarily disabling document security  
Documents having a password can temporarily be accessed without entering the password.

#### Note

- Default : *Do not Unlock*
- Only when you forget the password, select "Unlock". After you access the document, be sure to select "Do not Unlock".

#### Reference

p.150 "Unlocking a Locked Document", p.151 "Temporarily Disabling Document Security"

### ❖ Key Operator's E-mail Address

By registering the operator's e-mail address, you can send an e-mail in case of difficulty. Specify whether or not to use this function.

#### Note

- Default: *blank*

❖ **Machine E-mail Address**

Specify whether or not to use this function.

 **Note**

Default: *blank*

❖ **AOF (Always ON)**

Specify whether or not to use Auto Off.

 **Note**

Default: *ON*

❖ **Extended Security**

Specify whether or not to use security function.

 **Note**

Default : *Off*

You have to set the six-digit key operator code to set Extended Security. See p.69 “Key Operator Code”.

When the Extended Security function is On, a security mark  appears at the lower right of the display panel.

 **Reference**

For details about security, see p.149 “Security”.



# User Codes

By registering user codes, you can limit users to the following functions and check their use of each function.

- Copier
- Document Server
- Scanner
- Printer

## Note

- The number of copies scanned in scanner mode is counted for each user code. So you can check each user's usage.
- To register the user code of the printer driver automatically, select Auto Program for the printer in User Code Management. If you use the user code set in User Tools, select **[Off]**. Set the user codes registered in User Tools for the printer driver. See p.69 "User Code Management".

## Reference

For details about setting the user codes for the printer driver, see *Printer Reference* or the printer driver Help menu.

## Important

- The functions associated with each user code are the same. If you change or delete user codes, management data and restrictions related to that code will become invalid.

---

## Registering a New User Code

---

- 1** Press the **[User Tools]** key.
- 2** Press **[System Settings]**.
- 3** Press **[Key Operator Tools]**.
- 4** Press **[Address Book Management]**.
- 5** Press **[New Program]**.

## Note

- To assign a user code to a registered user, press the user key whose user code is to be registered, or enter the number using the number keys.

## 6 Set the user information.

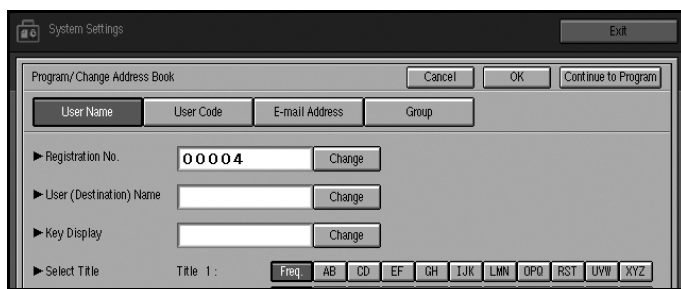

### Note

- To register a user code to a registered user, proceed to step **7**.

---

To register a user name and key display

---

### 1 Press [Change] on the right of the user name or key display.

The user name or key name entry screen appears.

### 2 Enter the user name or key display, and then press [OK].

#### Note

- You can use the user name as the user name assigned to the documents in Document Server mode. In this case, entry of the user code is not required. See p.35 "Document Server".

#### Reference

p.91 "Entering Text"

---

To select the title

---

### 1 Press the key for the classification you want to use from "Select Title".

#### Note

- The keys you can select are as follows.
  - [Freq.]... Added to the page that is displayed first.
  - [AB],[CD],[EF],[GH],[IJK],[LMN],[OPQ],[RST],[UVW],[XYZ]... Added to the list of items in the title selected.
- You can only select one page for "Select Title".

### 7 Press [User Code].

### 8 Enter the user code using the number keys, and then press [#] or the [#] key.

#### Note

- If you make a mistake, press [Clear] or the [Clear] key, and then enter the user code again.

- 9 Select the functions to be used with the user code from “Available Functions”.
- 10 To continue registering user codes, press [Continue to Program], and then repeat the procedure from step 6.
- 11 Press [OK].
- 12 Press [Exit].
- 13 Press the [User Tools] key.

---

## Changing a User Code

---

- 1 Press the [User Tools] key.
- 2 Press [System Settings].
- 3 Press [Key Operator Tools].
- 4 Press [Address Book Management].
- 5 Select the registered user code you want to change, or enter the registered number using the number keys.
- 6 Enter the new information for the item you want to change.

---

### Changing a user (destination) name or key display

---

- 1 Press [Change] to the right of the user (destination) name or key display.
- 2 Enter the user (destination) name, and then press [OK].

 **Reference**  
p.91 “Entering Text”

---

### Changing a title

---

- 1 Press the key for the classification you want to use from “Select Title”.

---

### Changing a user code

---

- 1 Press [User Code].
- 2 Press [Change], and then enter the new user code using the number keys.
- 3 Press the [#] key.

---

To change available functions

---

- 1 Press [User Code].
- 2 Press the key to select the functions to be enabled.

 **Note**

- Press the key making it highlighted, then the key is enabled.

- 7 Press [OK].
- 8 Press [Exit].
- 9 Press the [User Tools] key.

---

## Deleting a User Code

---

### Important

- This operation also deletes user codes registered for multiple functions. User control with the deleted user code will be disabled.

- 1 Press the [User Tools] key.
- 2 Press [System Settings].
- 3 Press [Key Operator Tools].
- 4 Press [Address Book Management].

---

To delete a user (destination)

---

- 1 Press [Delete].
- 2 Select the user (destination) you want to delete.  
Press the user (destination) key, or enter the registered number using the number keys.
- 3 Press [Yes] in the confirmation screen.

---

To delete the user code

---

- 1 Select a user (destination) whose user code is to be deleted.  
Press the user (destination) key to be deleted, or enter the registered number using the number keys.
- 2 Press [User Code].
- 3 Press [Clear] to delete the user code, and then press [#].
- 4 Press [OK].

- 5 Press [Exit].
- 6 Press the **[User Tools]** key.

---

## Displaying the Counter for Each User Code

---

You can check the counter for each function's user code.

- 1 Press the **[User Tools]** key.
- 2 Press **[System Settings]**.
- 3 Press **[Key Operator Tools]**.
- 4 Press **[Display/Clear/Print Counter per User Code]**.

---

## Printing the Counter for Each User Code

---

You can print out the counter for each user code using **[Print Counter]** or **[Scanner Counter]**. Also, you can print out using both together.

- 1 Press the **[User Tools]** key.
- 2 Press **[System Settings]**.
- 3 Press **[Key Operator Tools]**.
- 4 Press **[Display/Clear/Print Counter per User Code]**.

---

To print the number of copies (counter) for each user code

---

- 1 Select a user code from the left side of the display.

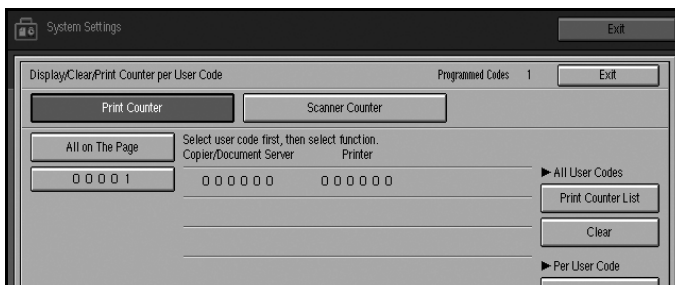

### Note

- Press **[All on The Page]** if you want to select all user codes on the page.

- 2 Press **[Print Counter List]** of "Per User Code".

### Note

- Enter the user code, and then press **[#]** if the user code is registered.

---

To print the number of copies (counter) for all user codes

---

**1** Press **[Print Counter List]** of “All User Codes”.

 **Note**

- Enter the user code, and then press **[#]** if the user code is registered.

**5** Press **[Print Counter]** or **[Scanner Counter]**.

**6** Press **[Print]**.

---

## Clearing the Counter

---

**1** Press the **[User Tools]** key.

**2** Press **[System Settings]**.

**3** Press **[Key operator Tools]**.

**4** Press **[Display/Clear/Print Counter per User Code]**.

**5** Select the user code to clear.

---

To clear the number of copies (counter) for each user code

---

**1** Select a user code from the left side of the display.

 **Note**

- Press **[All on The Page]** if you want to select all user codes on the page.

**2** Press **[Clear]** for “Per User Code”.

---

To clear the number of copies (counter) for all user codes

---

**1** Press **[Clear]** for “All User Codes”.

**6** Press **[Print Counter]** or **[Scanner Counter]**.

**7** Press **[OK]**.

# E-mail Destination

By registering an e-mail destination, you can send scanned documents by e-mail.

- It is easy to select an e-mail destination if you register “User (destination) name” and “Key name” for the e-mail destination.
- You can register an e-mail destination as a group.
- You can use the e-mail destination as the Sender's address. In this case, you can set a password in order to prevent use by unauthorized people.

## Reference

E-mail destination can also be registered using SmartNetMonitor for Admin (printer/scanner option required). See *Network Guide*.

---

## Registering an E-mail Address

---

- 1** Press the [User Tools] key.

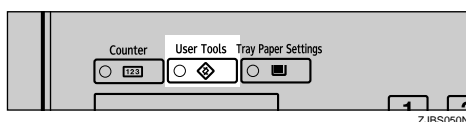

- 2** Press [System Settings].
- 3** Press [Key Operator Tools].
- 4** Press [Address Book Management].
- 5** Press [New Program].

### Note

- To register an e-mail destination to a registered user, press the user key you want to register, or enter the registered number using the number keys.

- 6** Set the user's information.

### Note

- To register an e-mail destination to a registered user, proceed to step **7**.

---

To register the user (destination) name and key name

---

- 1** Press [Change] on the right of “User (Destination) Name” or “Key Display”.

The user (destination) name or key name entry dialog box appears.

**2** Enter the user (destination) name or key name, and then press [OK].

**Note**

- You can use the user name when selecting an address to send e-mail to.
- You can register the user code following the user name. For more details, see p.75 “User Codes”.

**Reference**

p.91 “Entering Text”

---

To select the title

---

**1** To associate a user with a title, press the title key from “Select Title”.

**Note**

- The keys you can select are as follows.
  - [Freq.]... Added to the page that is displayed first.
  - [AB],[CD],[EF],[GH],[IJK],[LMN],[OPQ],[RST],[UVW],[XYZ]... Added to the list of items in the title selected.
- You can only select one page for “Select Title”.

**7** Press [E-mail Address].

**8** Enter the items you want to change.

---

Changing the e-mail address

---

**1** Press [Change] on the right of the “E-mail Address”.

The e-mail address entry dialog box appears.

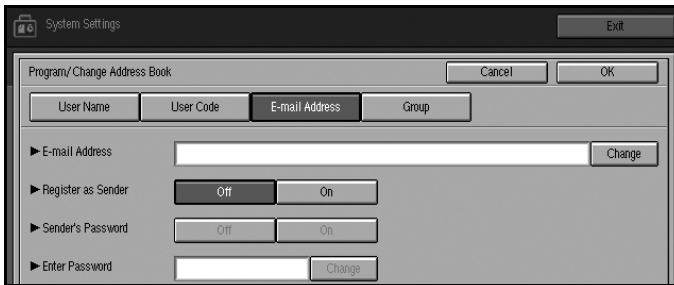

**2** Enter the e-mail address.

**Note**

- You can use the e-mail address as the Sender's address. In this case, you can set a password in order to prevent use by other people.



---

## Entering an e-mail address

---

- 1 When you finish entering address, press [OK].

---

## Using as a sender

---

You can use the entered e-mail address as a sender's address.

- 1 Press [On] on the right of the "Register as Sender".

---

## Setting a password

---

If you set Sender's Password to On, set the password.

- 1 Press [On] on the right of "Sender's Password".
- 2 Press [Change] on the right of the "Enter Password".
- 3 Enter the password using the number keys, and then press [#] or the [#] key.

- 9 Press [OK].

 **Note**

- When a group is registered, other e-mail destinations can be added to the group. See p.87 "Registering E-mail Destinations to a Group".

---

## Changing a Registered E-mail Destination

---

- 1 Press the [User Tools] key.

- 2 Press [System Settings].

- 3 Press [Key Operator Tools].

- 4 Press [Address Book Management].

The registered user list appears.

- 5 Select the user of the registered e-mail address you want to change.

Press the user key you want to change, or enter the registered number using the number keys.

- 6 Press [E-mail Address].

## **7** Enter the items.

---

To change the e-mail address

---

- 1** Press **[Change]** on the right of the e-mail address.
- 2** Enter the e-mail address, and then press **[OK]**.



### Reference

p.91 "Entering Text"

---

To change the password

---

- 1** Press **[Change]** on the right of "Enter Password".
- 2** Enter the new password using the number keys, and then press **[#]** or the **[#]** key.

## **8** Press **[OK]**.



### Note

- To change the user name, see p.77 "Changing a user (destination) name or key display".
- 

## Deleting a Registered E-mail Address

---

- 1** Press the **[User Tools]** key.
  - 2** Press **[System Settings]**.
  - 3** Press **[Key Operator Tools]**.
  - 4** Press **[Address Book Management]**.
- 

To delete only the e-mail address

---

- 1** Select the user whose e-mail address you want to delete.  
Press the user key you want to delete or enter the registered number using the number keys.
- 2** Press **[E-mail Address]**.
- 3** Press **[Change]** on the right of the "E-mail Address".
- 4** Press **[Delete All]**.
- 5** Press **[OK]**.
- 6** Press **[Exit]**.

---

**To delete all the user informations**

---

- ① Press [Delete].**
- ② Select the user you want to delete.**  
Press the user key you want to delete, or enter the registered number using the number keys.
- ③ Press [Yes].**
- ⑤ Press [Exit].**

# Registering E-mail Destinations to a Group

Registering groups has the following benefits:

- You can easily control the registered e-mail destinations for each group.
- You can send the same messages to multiple addresses in a group in bulk.

To divide e-mail destinations into groups, the groups must be registered beforehand.

## Reference

E-mail destination can also be registered into groups using SmartNetMonitor for Admin (printer/scanner option required). See *Network Guide*.

---

## Registering a New Group

---

5

**1** Press the **[User Tools]** key.

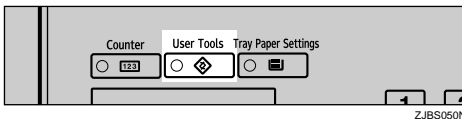

**2** Press **[System Settings]**.

**3** Press **[Key Operator Tools]**.

**4** Press **[Address Book: Program/Change/Delete Group]**.

**5** Press **[New Program]**.

**6** Press **[Change]** on the right of the “Group (Destination) Name”.

**7** Enter the group (destination) name, and then press **[OK]**.

**8** When you want to change the key display, press **[Change]** on the right of the key display. Enter the key display name, and then press **[OK]**.

### Note

- For entering the group name, the key display name is automatically set.

**9** Press the appropriate button in Select Title to sort the group. Proceed to step **10** if sorting is unnecessary.

**10** Press **[OK]**.

## Registering E-mail Destinations to a Group

You can register the e-mail destination to a group.

### Note

- When registering a new e-mail destination, you can register groups at the same time.

- 1** Press the **[User Tools]** key.
- 2** Press **[System Settings]**.
- 3** Press **[Key Operator Tools]**.
- 4** Press **[Address Book Management]**.
- 5** Select the user (destination) key that you want to register in a group.
- 6** Press **[Group]**.
- 7** Select a group to which you want to register the e-mail destinations.



- 8** Press **[OK]**.

---

## Deleting an E-mail Destination from a Group

---

- 1** Press the **[User Tools]** key.
- 2** Press **[System Settings]**.
- 3** Press **[Key Operator Tools]**.
- 4** Press **[Address Book Management]**.
- 5** Select the user (destination) key to delete from a group.

Press the user (destination) key that you want to delete, or enter the registered number using the number keys.

- 6** Press **[Group]**.
- 7** Press the group key you want to delete.



The user is deleted.

- 8** Press **[OK]**.

---

## Displaying the Destinations Registered in Groups

---

You can confirm the user (destination) of each group.

- 1** Press the **[User Tools]** key.
- 2** Press **[System Settings]**.
- 3** Press **[Key Operator Tools]**.
- 4** Press **[Address book: Program/Change/Delete Group]**.
- 5** Select a group where the data you want to confirm is registered.
- 6** Press **[Programed Users]**.

All user names (e-mail destinations) are displayed.

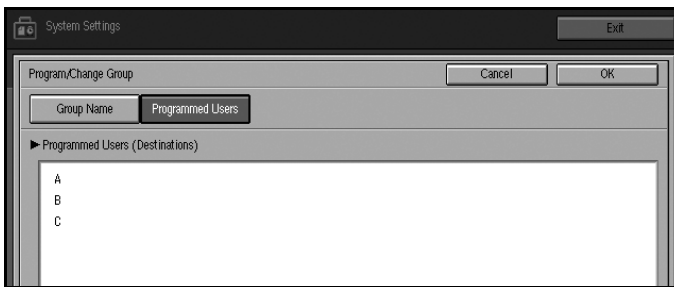

- 7** Press **[OK]**.

---

## Changing a Group Name

---

- 1** Press the **[User Tools]** key.
- 2** Press **[System Settings]**.
- 3** Press **[Key Operator Tools]**.
- 4** Press **[Address Book: Program/Change/Delete Group]**.
- 5** Press the group key you want to change.
- 6** Enter the item you want to change.

---

To change a group name or the key display

---

- 1** Press **[Change]** in “Group (Destination) Name” or “Key Display”.
- 2** Enter the group name or key display, and then press **[OK]**.

---

To change a title

---

- 1** Press the title key in “Select Title” of the group you want to sort.

---

To change a registration number

---

- 1** Press **[Change]** in “Registration No.”.
- 2** Enter the registration number using the number keys.
- 3** Press **[#]** or the **[#]** key.

- 7** Press **[OK]**.

---

## Deleting a Group

---

- 1** Press the **[User Tools]** key.
- 2** Press **[System Settings]**.
- 3** Press **[Key Operator Tools]**.
- 4** Press **[Address Book: Program/Change/Delete Group]**.
- 5** Press **[Delete]**.
- 6** Press the group key you want to delete.
- 7** Press **[Yes]**.



# Entering Text

This section describes how to enter characters. When you enter a character, it is shown at the position of the cursor. If there is a character at the cursor position, the entered character is shown before that.

---

## Available Characters

---

- Alphabetic characters  
ABCDEFGHIJKLMNOPQRSTUVWXYZabcdefghijklmnopqrstuvwxyz
- Symbols
- Numerals  
0123456789

---

## Keys

---

5

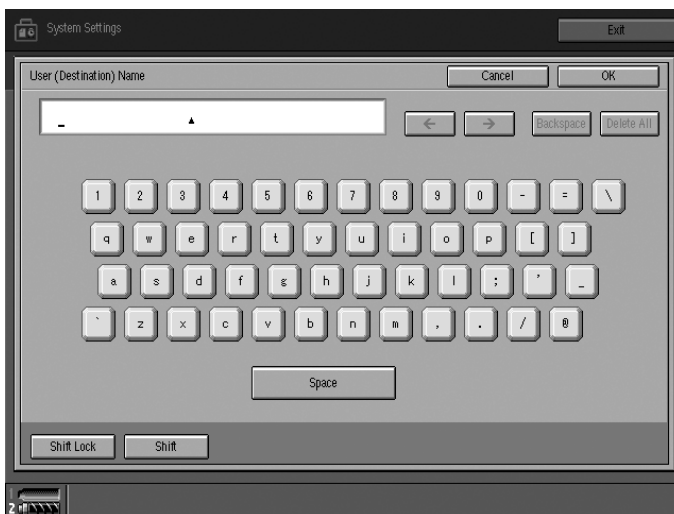

 **Note**

- ❑ When entering uppercase or lowercase letters continuously, use **[Shift Lock]** to lock the case.

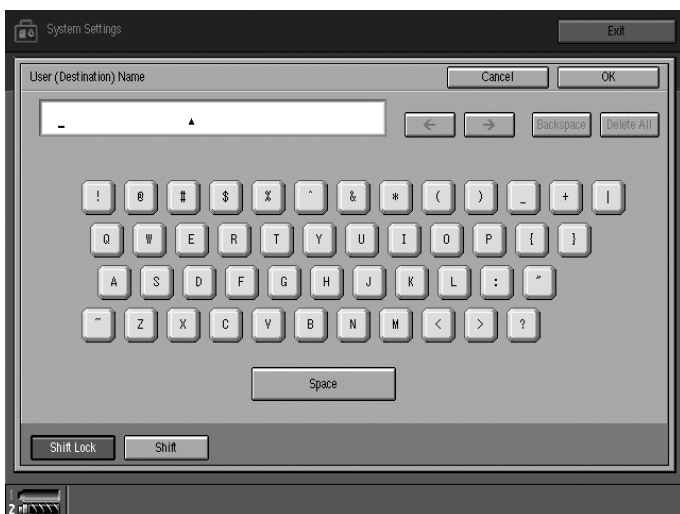

5

---

## Entering Text

---

### Entering letters

---

- 1 Press **[Shift]** to switch between uppercase and lowercase.
  - 2 Press the letters you want to enter.
- 

### Deleting characters

---

- 1 Press **[Backspace]** or **[Delete All]** to delete characters.

# 6. Paper Tray Settings

## Accessing Paper Tray Settings

This section is for paper settings in charge of this machine. You can change or preset the functions of the paper tray, Tray 1 to Tray 6, multi bypass tray (Tray 7), and the interposer.

### Note

- ❑ After using Paper Tray Settings, be sure to set the same size and type of paper in the tray. For loading paper, See p.102 “Loading Paper”.

---

## Changing Paper Tray Settings

---

- 1 Press the [Tray Paper Settings] key.

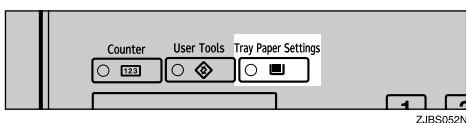

The Tray Paper Settings screen appears.

- 2 Select the tray number on the screen.

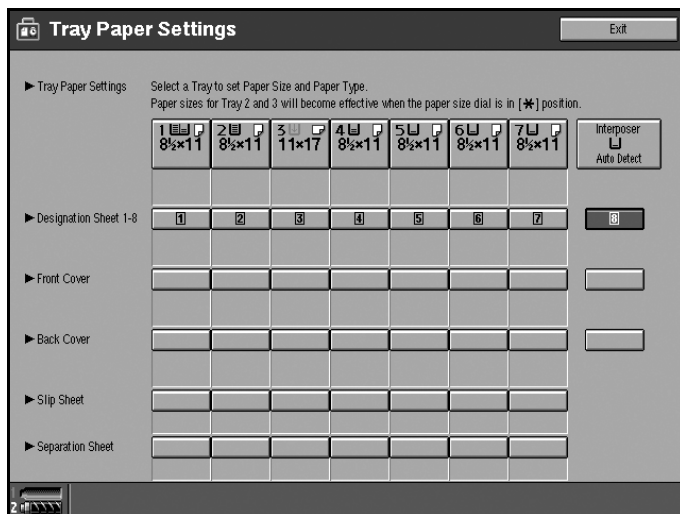

**3** Change settings, and then press [OK].

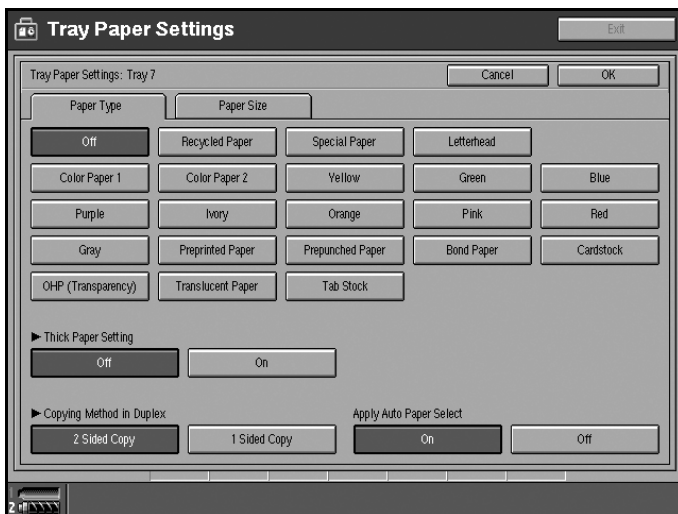

---

## Exiting Paper Tray Settings

---

6

**1** Press the [Tray Paper Settings] key.

 **Note**

- You can exit paper tray settings by pressing [Exit] on the tray paper settings display.

# Settings You Can Change with User Tools

## Tray Paper Settings

You can set the following items for each paper tray.

	Tray 1	Tray 2	Tray 3	Tray 4	Tray 5	Tray 6	Tray 7	Inter-poser
Paper Type	<input type="radio"/>	<input type="radio"/>	<input type="radio"/>	<input type="radio"/>	<input type="radio"/>	<input type="radio"/>	<input type="radio"/>	<input type="checkbox"/>
Paper Size	<input type="checkbox"/>	<input type="radio"/>	<input type="radio"/>	<input type="checkbox"/>	<input type="checkbox"/>	<input type="checkbox"/>	<input type="radio"/>	<input type="radio"/>
Thick Paper Setting	<input type="checkbox"/>	<input type="checkbox"/>	<input type="checkbox"/>	<input type="radio"/>	<input type="radio"/>	<input type="checkbox"/>	<input type="radio"/>	<input type="checkbox"/>
Copy Method in Duplex	<input type="radio"/>	<input type="radio"/>	<input type="radio"/>	<input type="radio"/>	<input type="radio"/>	<input type="radio"/>	<input type="radio"/>	<input type="checkbox"/>
Apply Auto Paper Select	<input type="radio"/>	<input type="radio"/>	<input type="radio"/>	<input type="radio"/>	<input type="radio"/>	<input type="radio"/>	<input type="radio"/>	<input type="checkbox"/>

### ◆ Paper Type

You can set the following paper type for each paper tray.

	Tray 1	Tray 2	Tray 3	Tray 4	Tray 5	Tray 6	Tray 7
Recycled Paper	<input type="radio"/>	<input type="radio"/>	<input type="radio"/>	<input type="radio"/>	<input type="radio"/>	<input type="radio"/>	<input type="radio"/>
Special Paper	<input type="radio"/>	<input type="radio"/>	<input type="radio"/>	<input type="radio"/>	<input type="radio"/>	<input type="radio"/>	<input type="radio"/>
Letterhead	<input type="radio"/>	<input type="radio"/>	<input type="radio"/>	<input type="radio"/>	<input type="radio"/>	<input type="radio"/>	<input type="radio"/>
Color Paper 1	<input type="radio"/>	<input type="radio"/>	<input type="radio"/>	<input type="radio"/>	<input type="radio"/>	<input type="radio"/>	<input type="radio"/>
Color Paper 2	<input type="radio"/>	<input type="radio"/>	<input type="radio"/>	<input type="radio"/>	<input type="radio"/>	<input type="radio"/>	<input type="radio"/>
Yellow	<input type="radio"/>	<input type="radio"/>	<input type="radio"/>	<input type="radio"/>	<input type="radio"/>	<input type="radio"/>	<input type="radio"/>
Green	<input type="radio"/>	<input type="radio"/>	<input type="radio"/>	<input type="radio"/>	<input type="radio"/>	<input type="radio"/>	<input type="radio"/>
Blue	<input type="radio"/>	<input type="radio"/>	<input type="radio"/>	<input type="radio"/>	<input type="radio"/>	<input type="radio"/>	<input type="radio"/>
Purple	<input type="radio"/>	<input type="radio"/>	<input type="radio"/>	<input type="radio"/>	<input type="radio"/>	<input type="radio"/>	<input type="radio"/>
Ivory	<input type="radio"/>	<input type="radio"/>	<input type="radio"/>	<input type="radio"/>	<input type="radio"/>	<input type="radio"/>	<input type="radio"/>
Orange	<input type="radio"/>	<input type="radio"/>	<input type="radio"/>	<input type="radio"/>	<input type="radio"/>	<input type="radio"/>	<input type="radio"/>
Pink	<input type="radio"/>	<input type="radio"/>	<input type="radio"/>	<input type="radio"/>	<input type="radio"/>	<input type="radio"/>	<input type="radio"/>
Red	<input type="radio"/>	<input type="radio"/>	<input type="radio"/>	<input type="radio"/>	<input type="radio"/>	<input type="radio"/>	<input type="radio"/>
Gray	<input type="radio"/>	<input type="radio"/>	<input type="radio"/>	<input type="radio"/>	<input type="radio"/>	<input type="radio"/>	<input type="radio"/>
Preprinted Paper	<input type="radio"/>	<input type="radio"/>	<input type="radio"/>	<input type="radio"/>	<input type="radio"/>	<input type="radio"/>	<input type="radio"/>
Prepunched Paper	<input type="radio"/>	<input type="radio"/>	<input type="radio"/>	<input type="radio"/>	<input type="radio"/>	<input type="radio"/>	<input type="radio"/>
Label	<input type="checkbox"/>	<input type="checkbox"/>	<input type="checkbox"/>	<input type="checkbox"/>	<input type="radio"/>	<input type="checkbox"/>	<input type="checkbox"/>
Bond Paper	<input type="radio"/>	<input type="radio"/>	<input type="radio"/>	<input type="radio"/>	<input type="radio"/>	<input type="radio"/>	<input type="radio"/>
Cardstock	<input type="radio"/>	<input type="radio"/>	<input type="radio"/>	<input type="radio"/>	<input type="radio"/>	<input type="radio"/>	<input type="radio"/>
OHP (Transparency)	<input type="checkbox"/>	<input type="radio"/>	<input type="radio"/>	<input type="radio"/>	<input type="radio"/>	<input type="radio"/>	<input type="radio"/>
Translucent Paper	<input type="checkbox"/>	<input type="radio"/>	<input type="radio"/>	<input type="radio"/>	<input type="radio"/>	<input type="radio"/>	<input type="radio"/>
Tab Stock	<input type="checkbox"/>	<input type="checkbox"/>	<input type="checkbox"/>	<input type="radio"/>	<input type="radio"/>	<input type="checkbox"/>	<input type="radio"/>

**Note**

- The number of tab stock shifts can be set to millimeters, when **[Tab Stock]** has been selected.
- “Thick Paper Setting” and “Tab Stock” can be set simultaneously. Thick Paper Setting and Color Sheet can be set simultaneously.

**❖ Paper Size****🔍 Reference**

You can select the size of the copy paper loaded in Tray 2, 3, 7, and the interposer. For the paper sizes you can load for each tray, see p.170 “Copy Paper”.

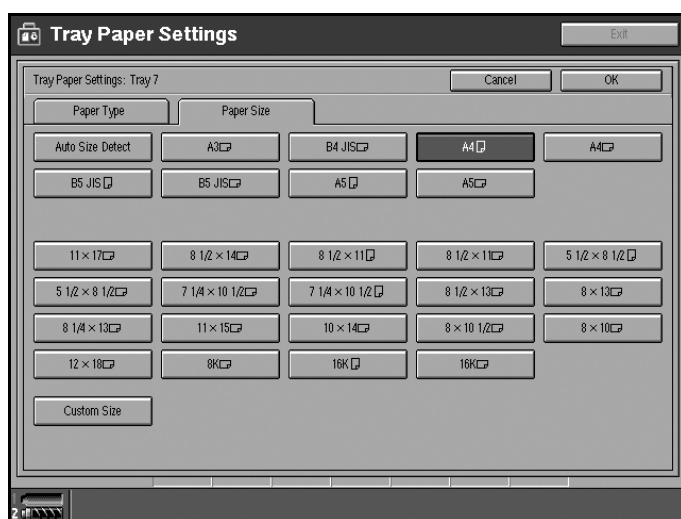
**⚠ Important**

- If the specified paper size differs from the size of paper actually set in the paper tray, a misfeed might occur because the paper size is not detected correctly.

**Note**

- For Tray 2 and Tray 3, setting of the selector knob takes priority. When setting paper of a size not indicated on the selector knob, set the knob to the **✖** mark.

**❖ Thick Paper Setting**

You can set the thick paper setting to **[On]** or **[Off]**.

**❖ Copy Method in Duplex**

You can select the copying method in duplex mode; 2 Sided Copy or 1 Sided Copy.

**❖ Apply Auto Paper Select**

You can set the Auto Select mode to **[On]** or **[Off]**.

---

## Designation Sheet 1-8

---

You can specify and display the paper tray to set designation sheets. After selecting, you can also specify the display timing and copying method for two sided copying.

### ❖ Display Setting

You can select On Mode Select or Always Display.

### ❖ Copying Method in Duplex

You can select 2 Sided Copy or 1 Sided Copy.

#### Note

- When you select the interposer, you cannot set details.
- When you select On Mode Select, settings for Designation Sheet 1 - 8 appear only when you select the designation sheet function.
- Copy Method in Duplex is enabled only when you select On Mode Select.
- When you select Always Display,  appears.

---

## Front Cover

---

6

You can specify and display the paper tray to set front cover sheets. After selecting the paper tray, you can also specify the display timing and copying method for two sided copying.

### ❖ Display Setting

You can select On Mode Select or Always Display.

### ❖ Copying Method in Duplex

You can select 2 Sided Copy or 1 Sided Copy.

#### Note

- When you select the interposer, you cannot set details.
- When you select On Mode Select, settings for Front Cover appear only when you select the front cover function.
- Copy Method in Duplex is enabled only when you select On Mode Select.
- When you select Always Display,  appears.

---

## Back Cover

---

You can specify and display the paper tray to set back cover sheets. After selecting the paper tray, you can also specify the display timing and copying method for two sided copying.

### ◆ Display Setting

You can select On Mode Select or Always Display.

### ◆ Copying Method in Duplex

You can select 2 Sided Copy or 1 Sided Copy.

#### Note

- When you select the interposer, you cannot set details.
- When you select On Mode Select, settings for Back Cover appear only when you select the back cover function.
- Copy Method in Duplex is enabled only when you select On Mode Select.
- When you select Always Display,  appears.

---

## 6

---

## Slip Sheets

---

You can specify and display the paper tray in which to set slip sheets. After selecting, you can also specify the display timing and copying method for two-sided copying.

#### Note

- When **[On Mode Select]** is selected, the cover settings options are only displayed when the cover function or slip sheet function is selected.
- OHP transparencies cannot be copied when using the interposer.
- You can select the interposer.

---

## Separation Sheets

---

You can specify and display the paper tray in which to set separation sheets. After selecting, you can also specify the display timing and copying method for two-sided copying.

#### Note

- When **[On Mode Select]** is selected, the cover settings options are only displayed when the cover function or slip sheet function is selected.
- When you select Always Display,  appears.





# 7. Troubleshooting

## If Your Machine Does Not Operate as You Want

### General

Machine Status	Problem/Cause	Action
Please wait.	This message appears when you turn on the operation switch or change the toner bottle.	Wait for the machine.
	The machine is preparing for copying images.	Wait for 30 to 40 seconds.
The display panel is off.	The screen contrast knob is turned to the dark position.	Set the screen contrast knob to the light position for proper viewing of the display panel.
	The machine is in Low Power mode.	Press the <b>[Energy Saver]</b> key to cancel Low Power mode.
	The operation switch is turned off.	Turn on the operation switch.
Nothing happens when the operation switch is turned on.	The main power switch is turned off.	Turn on the main power switch.
Memory is full.	The number of scanned pages exceeds the capacity of the hard disk.	Press <b>[Delete File]</b> to delete unnecessary documents. See p.51 "Deleting Stored Documents"
The function status indicator is red.	The function associated with the red indicator has been interrupted.	Press the function key corresponding to the indicator. Follow the instructions displayed in the display panel.
The operation switch continues blinking and does not turn off when pressed.	This occurs in the following cases: <ul style="list-style-type: none"><li>• The machine is in communication with external equipment.</li><li>• The hard disk is in operation.</li></ul>	Check that the computer does not control the machine when you turn off the main power switch.

Machine Status	Problem/Cause	Action
The original images are printed on the reverse side of the paper.	You may have loaded the paper incorrectly.	Load paper into the LCT another with the print side up, or into a paper tray with the print side down. See p.102 "  Loading Paper"
Misfeeds occur frequently.	The side guides of the paper tray may not be locked.	Check the side guides are locked. See p.122 "Changing the Paper Size"
	The end guide of the paper tray may not be locked.	Check that the end guide is locked. See p.122 "Changing the Paper Size"
	You may have loaded paper whose size cannot be detected automatically.	When you use paper of a size that cannot be detected automatically, set the paper size. See p.95 "Tray Paper Settings".
	The saddle stitching staple cartridge for the booklet finisher has been removed.	Reset the saddle stitching staple cartridge. See p.127 "  Adding Staples"
An error message remains, even if misfed paper is removed.	When a misfeed message appears, it remains until you open and close the cover, as required.	Clear misfed paper and open and close the front cover. See p.113 "  Clearing Misfeeds"
Cannot duplex print	You cannot use the paper in the multi bypass tray (Tray 7) for duplex printing.	For duplex printing, select Tray 1-3 in copier mode or with the printer driver.
	The setting for the Paper Type: Tray 1-3 is "1 Side Copy".	Select "2 Sided Copy" for Paper Type: Tray 1-3
During saddle stitching, paper comes out open and not neatly stacked.	Depending on the type of paper, the paper opens as it rebounds when it is folded.	Select a paper type with low rebound.
The user code entry dialog box is displayed.	Users are restricted by user management.	Enter the user code (up to 8-digits), and then press the <b>【#】</b> key.

## Document Server

Problem	Action
“Scanned pages exceeded max. number. Do you want to store the scanned pages as a file?” appears.	<p>The number of scanned pages exceeds the capacity per file of the Document Server.</p> <p>If you want to store scanned originals as a file, press <b>[Yes]</b>. The originals are stored as a file in the Document Server.</p> <p>If you don't want scanned originals to be stored, press <b>[No]</b>. The scanning data will be cleared.</p>
You forgot your password.	<p>You can confirm your password.</p> <p>Press <b>[Unlock]</b> for “Temporarily Unlock Files” in <b>[Password Management for Stored Files]</b> of User Tools. You can check the password when you have selected the file.</p> <p>You can delete all the saved documents at once with the User Tools.</p> <p>Make sure that no important documents are saved in the Document Server before deleting all saved documents.</p> <p>See p.51 “Deleting Stored Documents”.</p>
You cannot find out what is saved in a file.	Check the date or time column in the “Document Server: Files” display.
	Check the contents of the document by printing the first page of it. Press the desired document in the “Document Server: Files” display, and press <b>[Print selected Page]</b> followed by the <b>[Start]</b> key.
Memory becomes full frequently.	Press <b>[Delete File]</b> to delete selected documents, thereby increasing available memory.
You want to check print before making a large print run.	Check print quality by printing out only the first set using the <b>[Sample Copy]</b> key.
“Cannot copy. Original is being scanned by other functions.” appears.	The Copy function is in use. To cancel the job in process, first press <b>[Exit]</b> , and then press the <b>[Copy]</b> key. Next press the <b>[Stop]</b> key. When the message “ <b>[Stop]</b> key was pressed. Stop printing?” appears, press <b>[Stop]</b> .

# 📄 Loading Paper

## 📌 Note

- ❑ You can change the paper size in tray 2, 3, 4 and 5. See p.122 “Changing the Paper Size”.
- ❑ Fan the paper before loading.
- ❑ Straighten curled or warped paper before loading.

## 🔍 Reference

For details about paper types and sizes, see p.170 “Copy Paper”.

---

## Loading Paper in Tray 1 (Tandem Tray)

---

### ⚠️ Important

- ❑ When paper on the right side in tray 1 runs out, paper on the left will automatically move to the right. While the paper is moving, the machine instructs you to wait. At this time, do not pull out the tray.

### 📌 Note

- ❑ You can load paper even while making copies using paper in tray 1. During copying, you can pull out the left half of the tray.

Load the same size and orientation paper in the other half of the tray.

### 1 Pull out the paper tray until it stops.

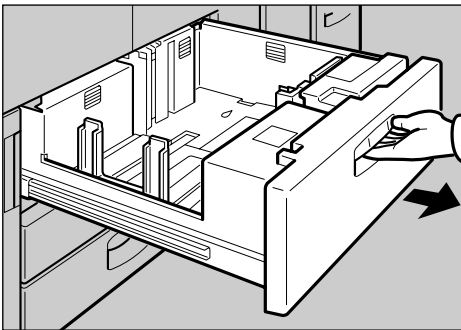

ZAKY010E

**2** Square the paper, and then load it in the tray.

When the whole tray is pulled out

**1** Load the paper.

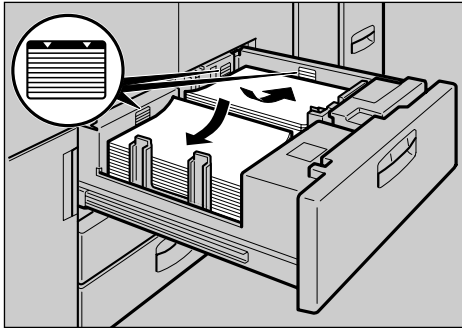

ZJBY030E

**Important**

- Confirm that the top of the stack is not higher than the limit mark inside the tray.
- Align the right edge of the copy paper stack in the right tray to the right edge of the tray, and the left one to the left edge of the tray.

When the left half of the tray is pulled out

7

**1** Load the paper in the left tray.

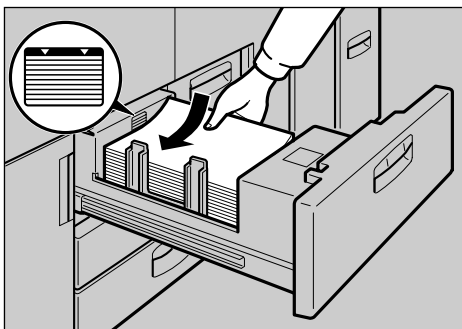

ZAKY030E

**Important**

- Confirm that the top of the stack is not higher than the limit mark inside the tray.
- Align the left edge of the paper stack to the left edge of the tray.

**3** Gently push the paper tray in until it stops.

---

## Loading Paper in Tray 2 and 3

---

**1** Pull out the paper tray until it stops.

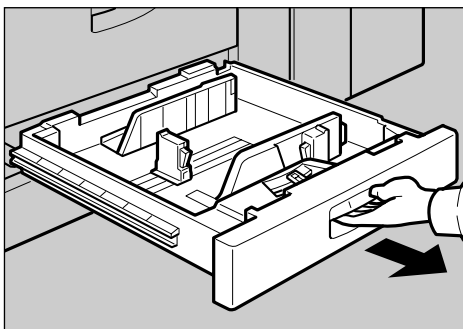

ZAJY040E

**2** Square the paper, and then load it in the tray.

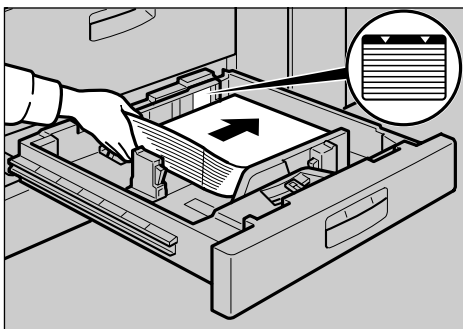

ZAJY050E

**Important**

- Confirm that the top of the stack is not higher than the limit mark inside the tray.
- Align the right edge of the copy paper stack to the right edge of the tray.

**3** Gently push the paper tray in until it stops.

## Loading Paper in the Large Capacity Tray (Tray 4, Tray 5, and Tray 6)

**1** Pull out the LCT until it stops.

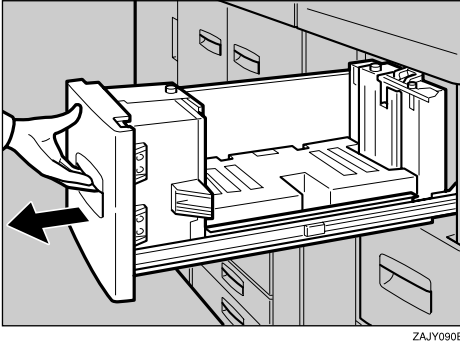

**2** Place the paper in the tray along the edge on the left.

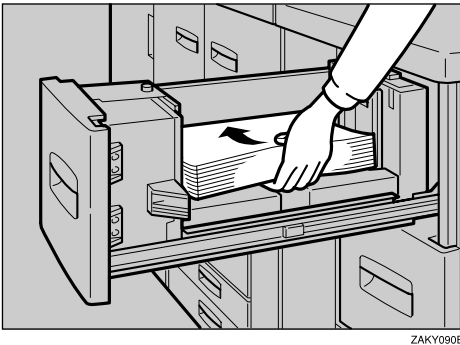

### Important

Do not stack paper over the limit mark.

Align the left edge of the copy paper stack to the left edge of the tray.

### Note

Tray 4 and Tray 5 can hold up to 1,000 sheets, and Tray 6 can hold up to 2,550 sheets.

**3** Push the LCT in until it stops.

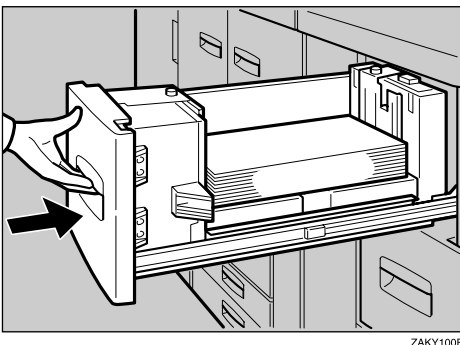

## Loading Paper in the Optional A3/11" × 17" Tray Kit

**1** Pull out the A3/11" × 17" Tray until it stops.

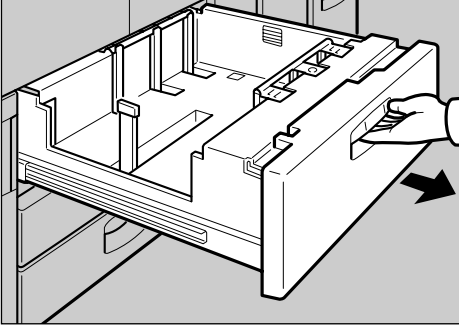

ZAJY010E

**2** Place the paper in the tray along the edge on the left.

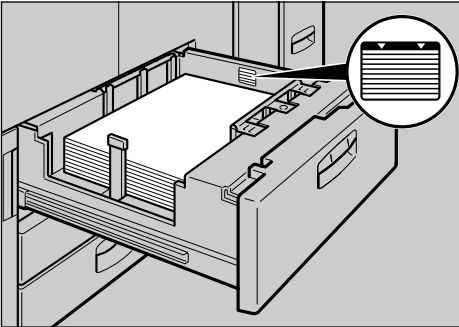

ZJBY020E

### **Important**

- Do not stack paper over the limit mark.
- Make sure that the paper stack is flush to the right side fence.

**3** Push the paper tray in until it stops.

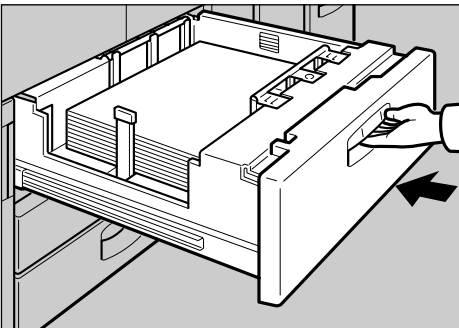

ZAJY520E



## Loading Paper in the Interposer

### Important

- Load paper on the side already printed (the side you want as front).
- Load paper in the interposer in the same orientation as paper in the paper tray.
- The staple or punch position will be on the left side of the paper, when you are facing the machine.
- Do not place anything on top of or leave originals on the sensor. This may lead to paper jams or the paper size not being correctly scanned.

### 1 Load the paper.

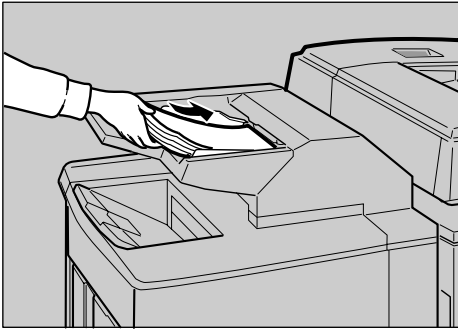

ZJBY610E

### Note

- To set the paper in the interposer, align the orientation of originals in the ADF as shown below.

ADF	Interposer

GCNTP0E

- Make sure the top of the stack is not higher than the limit mark inside the tray.



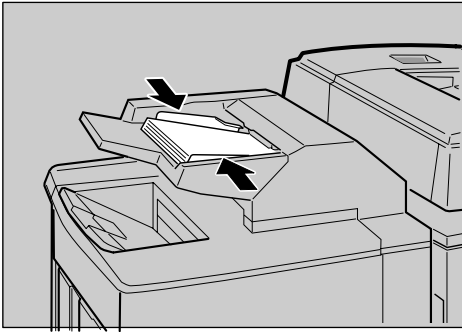





**2** Adjust the paper guides to the paper size.



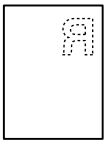

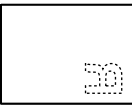
ZJBY620E

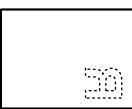
## Orientation-Fixed Paper or Two-Sided Paper

Orientation-fixed (top to bottom) or two-sided paper (for example, letterhead, punched, or copied paper) might not be printed correctly depending on how the originals and paper are placed. Select [Letterhead setting] in system settings, and then place the original and paper as shown below. See *Copy Reference*. When printing with the printer function, the placing orientation is the same.

Copier mode		Tray 1, 2, 3	Tray 4, 5, 6, multi bypass tray (Tray 7)
		Exposure glass 	1 Sided
ADF 	2 Sided		
Exposure glass 	1 Sided		
ADF 	2 Sided		

 : Displays the paper frontside facing up.

 : Displays the paper backside facing up.

GLTHD01E

# Pausing Copy When Using Finisher 3000B (100-Sheet Staples)

You can pause a large volume of copies when using Finisher 3000B (100-Sheet Staples).

 **Note**

- You can suspend copy only when the output tray is specified as the finisher shift tray. See p.64 "Output: Copier".

**1** Press the **[Suspend/Resume]** key.

The key lights up.

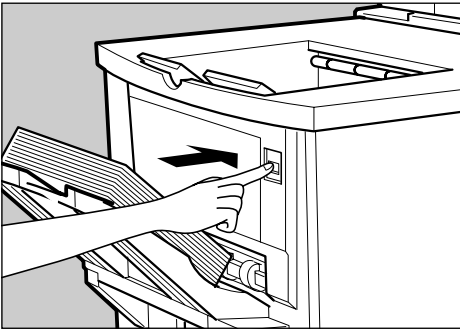

**2** Remove the stack of paper from the finisher shift tray.

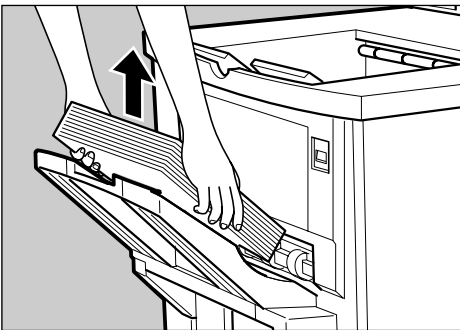

**3** Press the **[Start]** key.

The key turns off, and then copying restarts.

# Adding Toner

When  is displayed, it is time to supply toner.

## **WARNING:**

- ***Do not incinerate used toner or toner containers. Toner dust might ignite when exposed to an open flame. Dispose of used toner containers in accordance with local regulations.***

## **CAUTION:**

- *Keep toner (used or unused) and toner containers out of reach of children.*



## **CAUTION:**

- *Our products are engineered to meet high standards of quality and functionality, and we recommend that you use only the expendable supplies available at an authorized dealer.*

## **Important**

- If you use toner brands other than those recommended, a fault might occur.
- When changing toner, do not turn off the operation switch or your settings will be cleared.
- Always add toner when the machine instructs you to.
- Do not use recycled toner. This will damage the machine.
- During toner adding, the toner bottle is rotating. Do not touch the toner bottle.
- If toner remains in the bottle, you cannot remove the bottle. Do not remove the bottle forcibly.
- Be sure to set the new toner bottle in the lower hole first.

## **Note**

- If both toner bottles are empty,  will appear.
- You can still make about 200 copies after  appears, but replace the toner early to copy degradation.
- If one of the toner bottle is empty, you can keep copying by using the other bottle.
- You can change the toner bottle during copying.
- If toner remains in the bottle, you cannot pull it out.
- When you change one toner bottle, do not touch the other one.

## **Reference**

For how to store toner, see p.142 “Toner Storage”.

# Replacing Toner

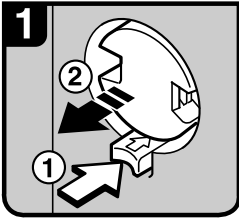

ZJBT010E

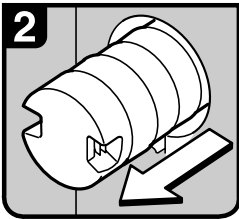

ZJBT020E

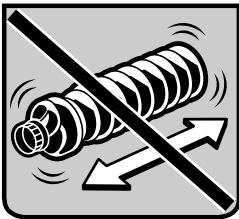

ZJBT030E

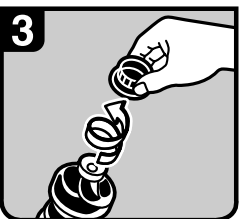

ZJBT040E



ZJBT050E

- Open the toner cover.

**Reference**

For the location of the toner cover, see p.17 “Guide to Components”.

- Push the green button to release the toner bottle.

- Gently pull out the toner bottle gently.

**Note**

- Do not shake the toner bottle strongly or toner might spill out.

- Remove the outer cap.

**Note**

- Do not remove the inner cap.

- Place the toner bottle in position, and then push it in until the green button clicks.

**Important**

- Be sure to set the new toner bottle in the lower hole first.

**Note**

- If you cannot get it to click in, pull out the toner bottle a little, slightly rotate it to the left or right, then try again.



- Return the button under the toner bottle to its original position.
- Close the toner cover.

## Clearing Misfeeds

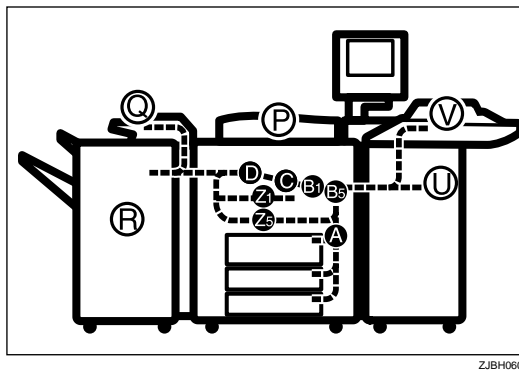

### ⚠ CAUTION:

- *The fusing section of this machine might be very hot. Caution should be taken when removing misfed paper.*

### ⚠ Important

- When clearing misfeeds, do not turn off the operation switch or your copy settings will be cleared.
- To prevent misfeeds, do not leave any torn scraps of paper inside the machine.
- If paper misfeeds occur repeatedly or you cannot remove the misfed paper in spite of following the instructions, contact your service representative. You might be requested to check the jam code number displayed in the upper part of the screen.

### 📝 Note

- More than one misfeed area may be indicated. In this case, check every applicable area. Refer to the following charts: A, B, C, D, U, P, Q, R (R1 – R6), V, Z
- You can find a sticker explaining how to remove misfeed paper inside of the front cover or inside of the finisher.

## When R is lit

### Finisher 3000B (100-Sheet Staples)

When R1, R2, or R3 is lit

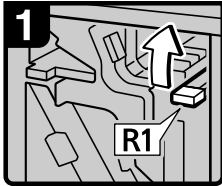

- Open the front cover.
- Raise lever R1.

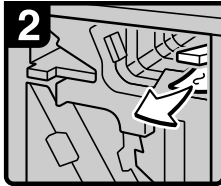

- Remove misfed paper.

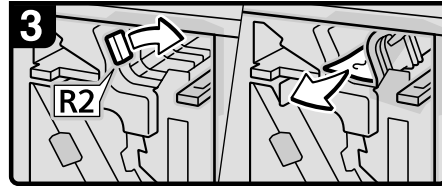

- If you cannot remove misfed paper, turn lever R2 to the right and remove it.

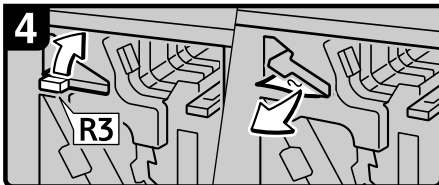

- If you cannot remove misfed paper, raise lever R3 and remove it.

When R4 or R5 is lit



- Open the front cover.
- Pull lever R4 and remove misfed paper.



- If you cannot remove misfed paper, pull lever R5 and remove it.

When R6 or R7 is lit

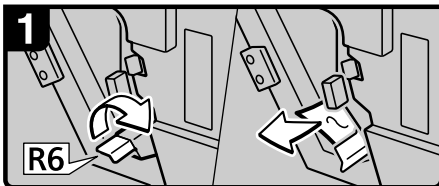

- If you cannot remove misfed paper, raise lever R6 and remove it.

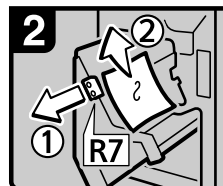

- Pull handle R7 and pull out the staple unit, then remove misfed paper.
- Close the front cover.



## When Q is lit

### Interposer

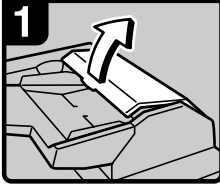

- Open the interposer upper cover.

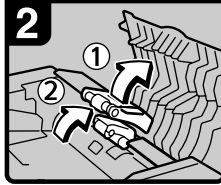

- Raise the feed roller.

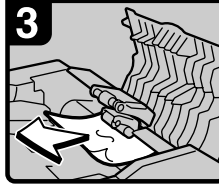

- Remove misfed paper.
- Close the interposer upper cover.

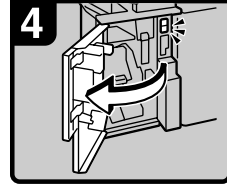

- Open the finisher front cover.

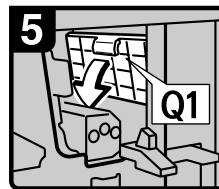

- Lower lever Q1.

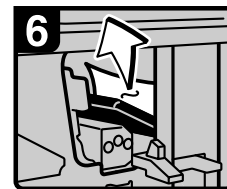

- Remove misfed paper.
- Close the finisher front cover.

## When V is lit

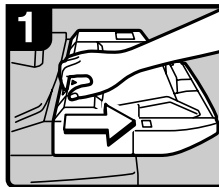

- Disconnect multi bypass tray (Tray 7).

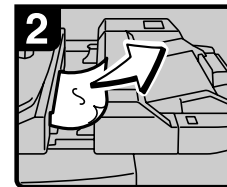

- Remove misfed paper.

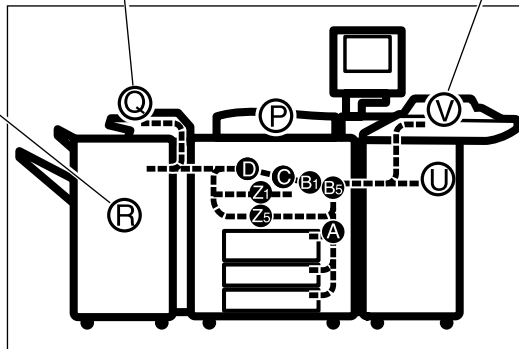

## When R is lit

### Booklet Finisher

When R1, R2, or R3 is lit

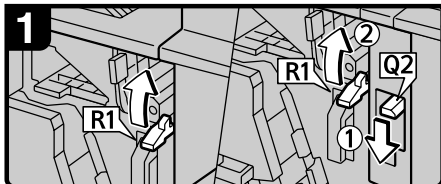

- Open the front cover.
- Raise lever R1.
- When the optional interposer is installed, lower lever Q2, and then raise lever R1.

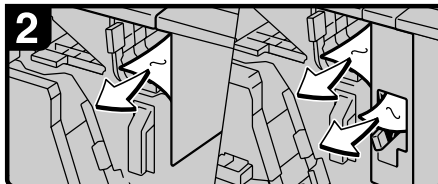

- Remove misfed paper.

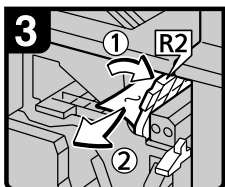

- If you cannot remove misfed paper, raise lever R2 and remove it.

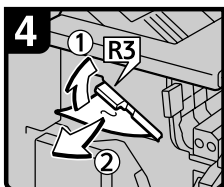

- Raise lever R3 and remove misfed paper.
- Close the front cover.

When R4, R5, or R6 is lit

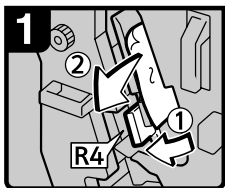

- Open the front cover.
- Lower lever R4 and remove misfed paper.

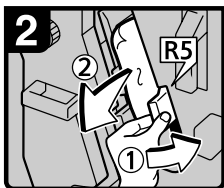

- If you cannot remove misfed paper, lower lever R5 and remove it.

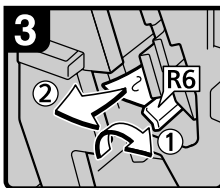

- If you cannot remove misfed paper, raise lever R6 and remove it.

When R7, R8, or R9 is lit

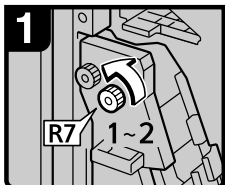

- Turn knob R7 counter-clockwise.

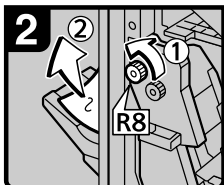

- Turn knob R8 counter-clockwise and remove misfed paper.

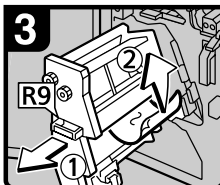

- Pull handle R9 and pull out the staple unit, and then remove misfed paper.
- Close the front cover.

## When D is lit

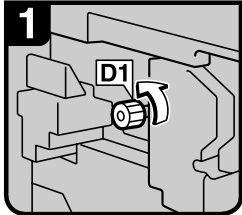

- Open the front cover of the machine.
- Turn knob D1 counterclockwise a few times.

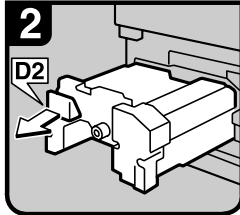

- Pull lever D2 and fully pull out the fuser unit.

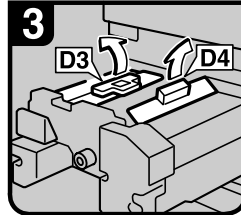

- Pull up lever D3 and D4.

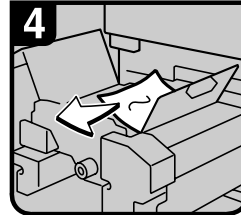

- Remove misfed paper and return lever D3 and lever D4 to original position.

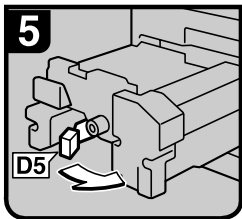

- Turn lever D5.

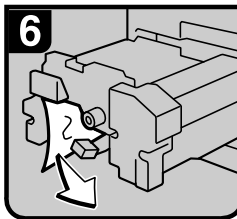

- Remove misfed paper.

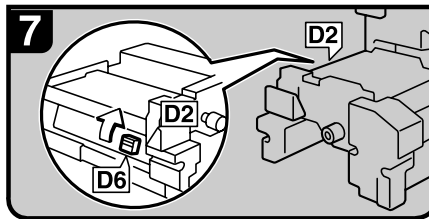

- Hold up lever D6.

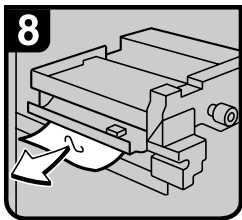

- Remove misfed paper.
- Return the fuser unit to original position.
- Close the front cover.

➔ **Z1**  
**2-7**

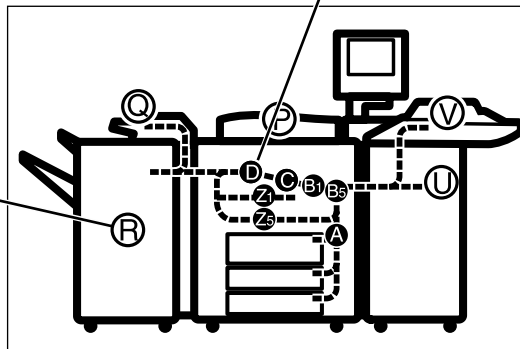

ZJFH070E

### When Z1 is lit

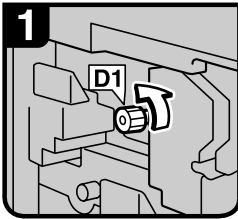

- Open the front cover of the machine.
- Turn knob D1 counter-clockwise a few times.

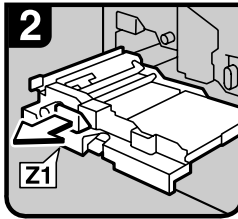

- Pull handle Z1 and fully pull out the duplex unit.

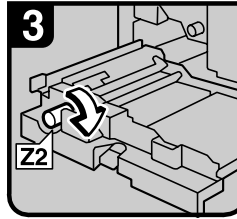

- Turn knob Z2.

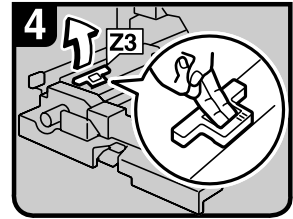

- Hold up lever Z3.

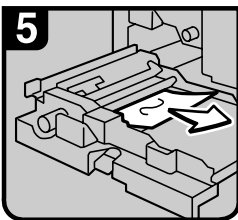

- Remove misfed paper.

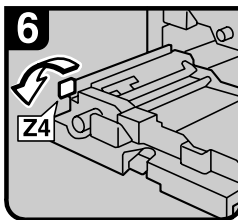

- Turn lever Z4.

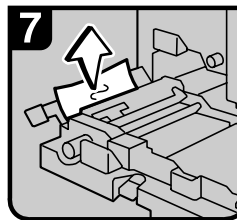

- Remove misfed paper.

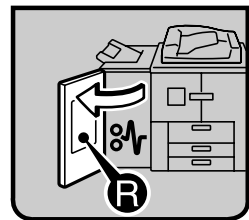

### When Z5 is lit

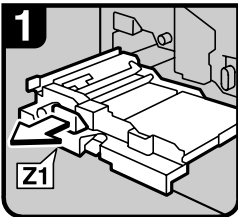

- Pull handle Z1 and fully pull out the duplex unit.

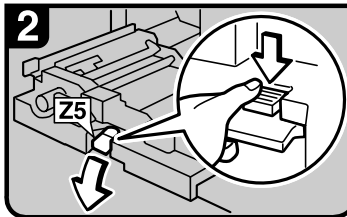

- Hold down handle Z5.

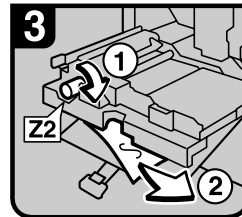

- Turn knob Z2 and remove misfed paper.
- Return handle Z5 to its original position.
- Push the duplex unit.
- Close the front cover.

### When B1 is lit

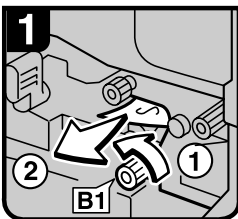

- Open the front cover of the machine.
- Turn knob B1 and remove misfed paper.

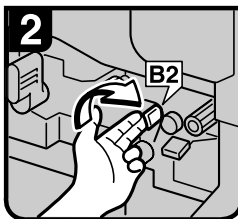

- Hold down lever B2.

### When A is lit

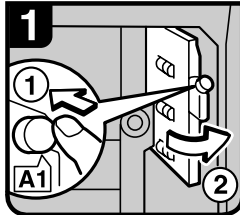

- Open the front cover of the machine.
- Push button A1 and open the guide plate.

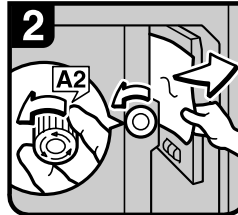

- Turn knob A2 and remove misfed paper.
- Close the guide plate.
- Close the front cover.

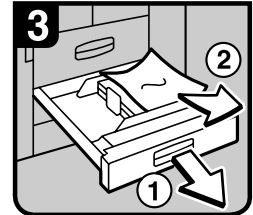

- If you can not remove misfed paper, pull the paper tray and remove it.

### When B5 is lit

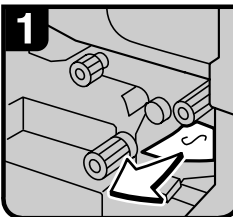

- Turn knob B3.
- Close the guide plate.
- Close the front cover.

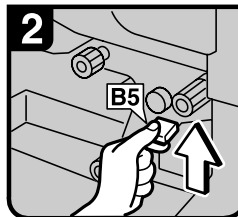

- Push button B5 and open the guide plate.

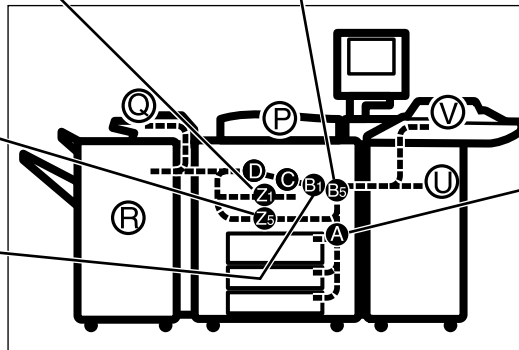

### When P is lit

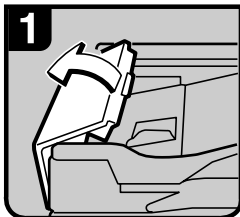

- Open the cover of the ADF.

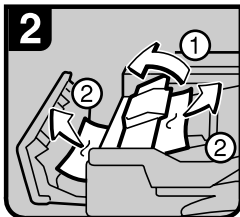

- Remove misfed originals.
- Close the cover of the ADF.

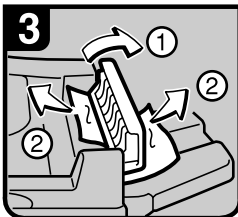

- Open the cover of the ADF and remove misfed originals.
- Close the cover of the ADF.

### When C is lit

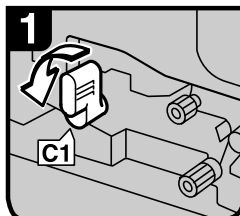

- Open the front cover of the machine.
- Hold lever C1 with your right hand, and then pull it down towards the left.

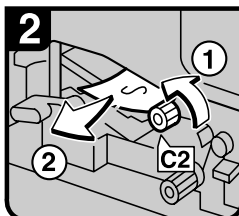

- Turn knob C2 and remove misfed paper.
- Return lever C1 to original position.
- Close the front cover.

## When U is lit

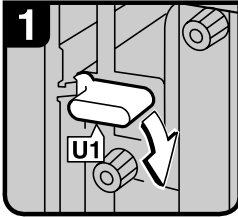

- Open the front cover of the machine.
- Hold down lever U1.

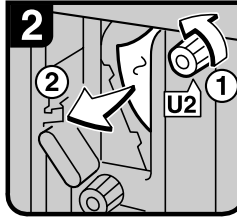

- Turn knob U2 and remove misfed paper.
- Return lever U1 to original position.

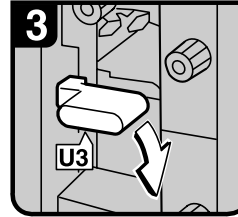

- Hold down lever U3.

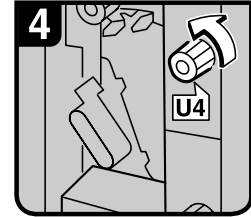

- Turn knob U4.

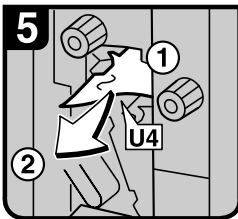

- Remove misfed paper.

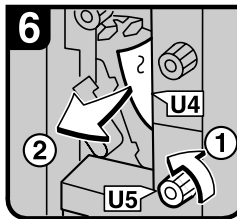

- Turn knob U5 and remove misfed paper.

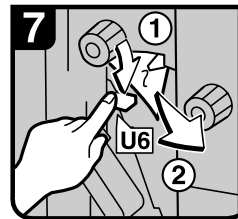

- Hold down lever U6 and remove misfed paper.

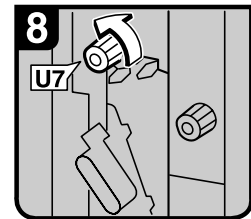

- Turn knob U7 and remove misfed paper.
- Return lever U3 to original position.
- Close the front cover.

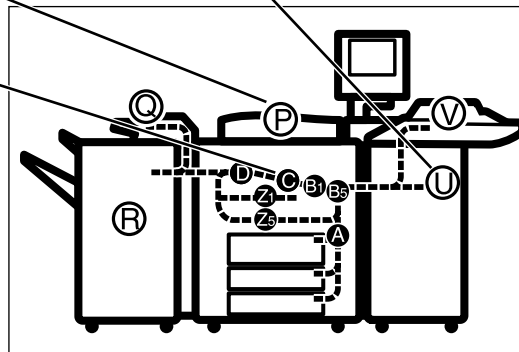

## Changing the Paper Size

### Preparation

Be sure to select the paper size with Paper Tray Settings. Otherwise, misfeeds might occur. See p.170 “Copy Paper”.

### Important

- If you want to change the paper size set in paper tray 1 or the LCT, contact your service representative.

### Reference

For details about paper sizes and types, see p.93 “Paper Tray Settings” and p.170 “Copy Paper”.

### Note

- Fan the paper before placing it in the tray.
- If paper is curled or warped, straighten it before placing in the tray.

## Changing the Paper Size of the Optional A3/11" × 17" Tray Unit (Tray 1)

### Note

- The fence of the optional, A3/11" × 17" tray unit (Tray 1) is fixed to A4, 8<sup>1</sup>/<sub>2</sub>" × 11" size.
- When you set tab stock in the tray, always use the end fence.

To change the paper size of this tray, contact your service representative.

## Changing the Paper Size in Tray 2 or 3

- 1** Make sure the paper tray is not being used, and then Pull the paper tray fully out.

Remove the paper from the tray.

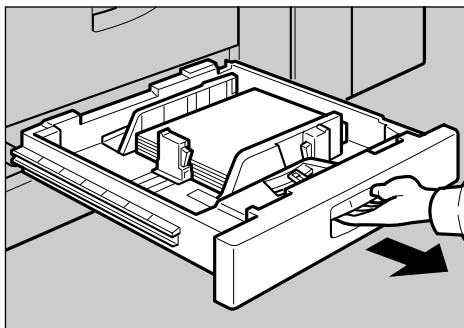

ZAJY011E



- 2** Press the lock button, and then adjust the back and side fences to the new paper size while pushing the release lever.

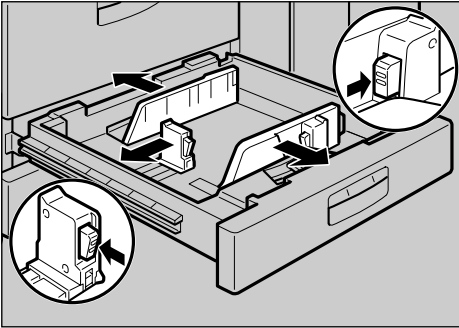

ZAKY400E

- 3** Square the paper and load it in the paper tray, and then press the lock button.

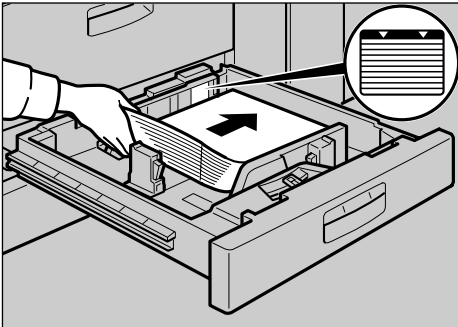

ZAJY050E

### **Important**

- Confirm that the top of the stack is not higher than the limit mark inside the tray.
- Align the right edge of the copy paper stack to the right edge of the tray.

- 4** Set the paper size selector knob inside the tray to the new size.

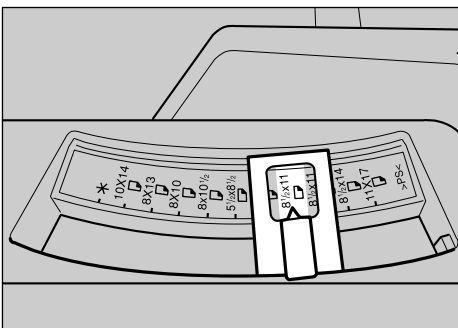

ZAJY450N

**Important**

- ❑ Problems might occur if the size of the paper set does not match the paper size selector, such as:
  - Misfeeds
  - Parts of the image are not copied

---

To adjust the paper size to one not available on the paper size selector

---

- ❶ Set the paper size selector knob to the ✖ mark on the left.
  - ❷ Press the **[Tray Paper Settings]** key.
  - ❸ Press **[Paper Size]**.
  - ❹ Select the size, and then press **[OK]**.
  - ❺ Press **[Exit]** or press the **[Tray Paper Settings]** key to exit the Tray Paper Setting.
- ❻ Gently push the paper tray until it stops.
  - ❼ Check the paper size displayed on the display panel.

---

## Changing the Paper Size of the Large Capacity Tray (Tray 4 and 5)

---

- ❶ Make sure that the paper tray is not being used, and then pull the tray fully out.

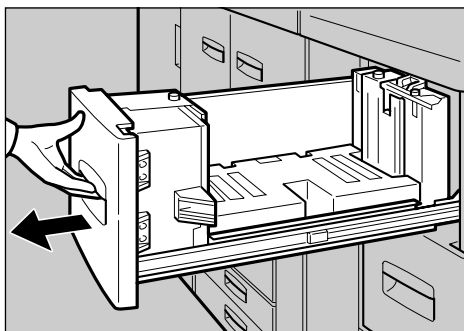

ZA/JY090E

**2** Pull out the screws fixing the side fence.

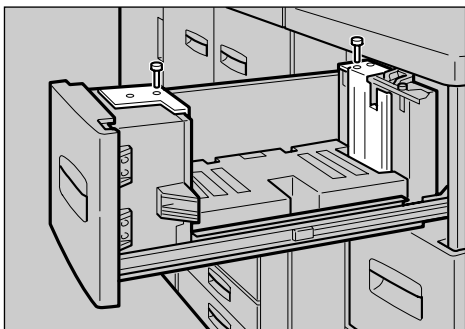

ZAJY460E

**3** Set the side fences to the size you want.

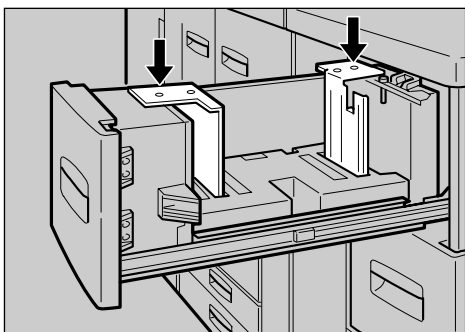

ZAJY470E

**4** Fasten the side fence with the screws.

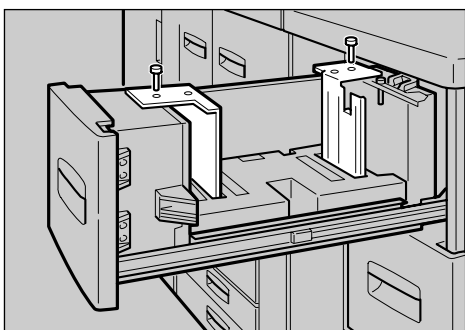

ZAJY480E

**5** Set the end fence along the paper size.

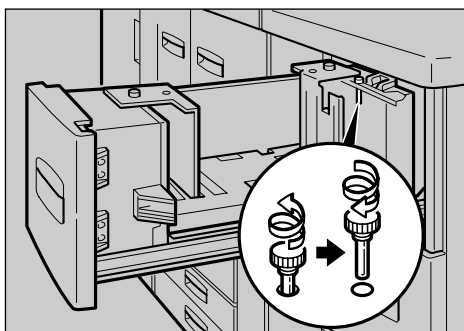

ZAJY490E

**6** Square the paper and set it in the tray.

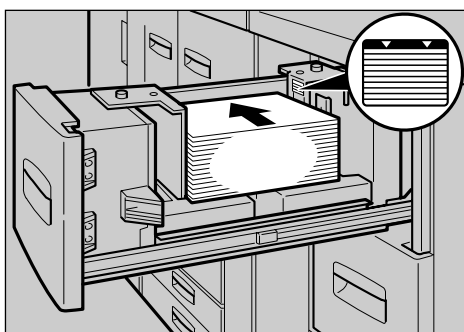

ZJBY600E

7

**Important**

Do not load over the lowest level mark.

**7** Set the paper size selector in the innermost part of the tray to the new paper size.

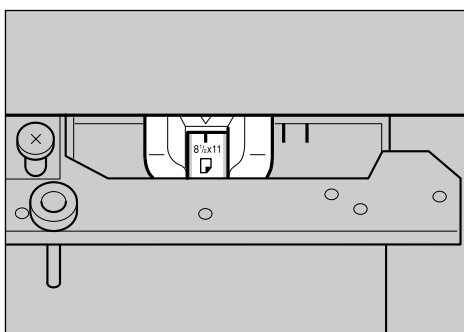

ZAJY510N

# Adding Staples

## Note

- When removing jammed staples, staples might not be ejected the first few times you try to use the stapler.

## Important

- If you use a staple cartridge other than that recommended, staple failure or staple jams might occur.
- A paper jam will occur if the machine staples using the booklet finisher without the saddle stitch stapler cartridge. Make sure the cartridge is set.

## Reference

For details about the type of finisher, see p.19 “External Options”.

## Booklet Finisher

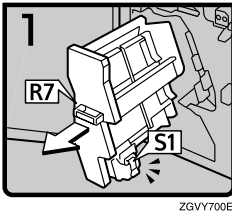

- Open the finisher front cover.
- Pull out the staple unit.

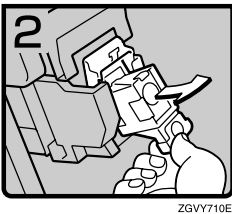

- Gently pull out the cartridge.

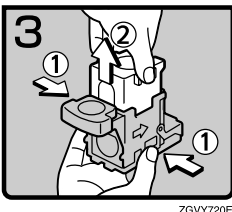

- Pull up the upper unit of the cartridge while holding both sides of the cartridge.

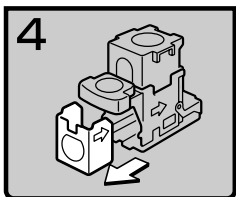

ZGVY730E

- Take out the empty refill in the direction of the arrow.

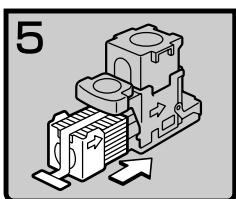

ZGVY740E

- Align the arrows on the new refill and the cartridge, and then push in the refill until it clicks.

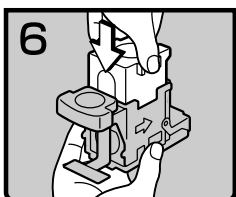

ZGVY750E

- Gently push down the upper unit into the cartridge.

7

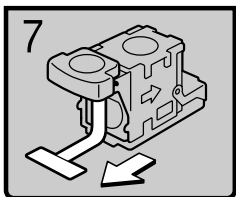

ZGVY760E

- Pull out the ribbon.

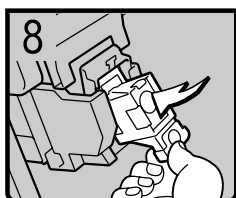

ZGVY770E

- Push the cartridge down until it clicks.

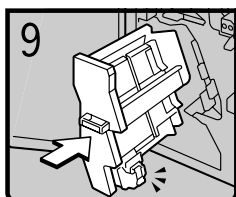

ZGVY780E

- Return the staple unit to its original position.
- Close the finisher front cover.

## Booklet Finisher (Saddle Stitch)

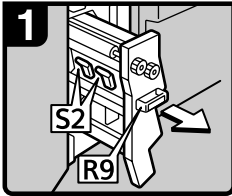

ZGVY790E

- Open the finisher front cover.
- Pull out the staple unit.

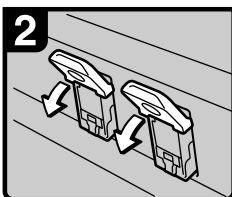

ZGVY800E

- Pull lever S2.

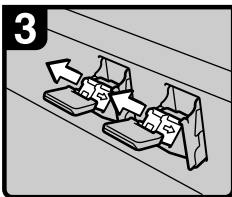

ZGVY810E

- Gently pull out the cartridge.

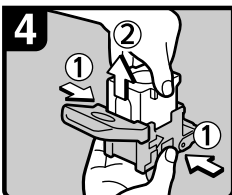

ZGVY820E

- Pull up the upper unit of the cartridge while holding both sides of the cartridge.

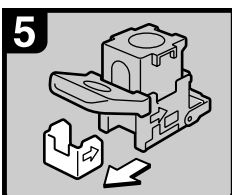

ZGVY830E

- Take out the empty refill in the direction of the arrow.

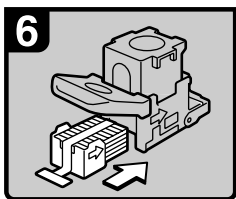

ZGVY840E

- Align the arrows on the new refill and the cartridge, and then push in the refill until it clicks.

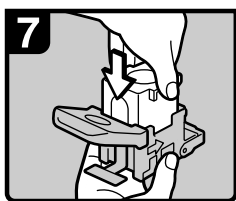

ZGVY850E

- Gently push down the upper unit into the cartridge.

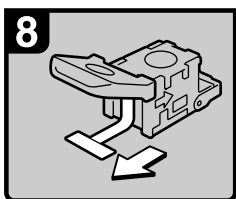

ZGVY860E

- Pull out the ribbon.

7

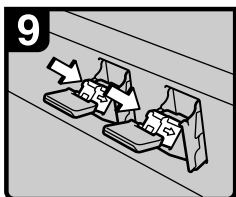

ZGVY870E

- Push the cartridge down until it clicks.

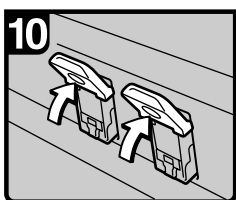

ZGVY880E

- Return lever S2 to its original position.

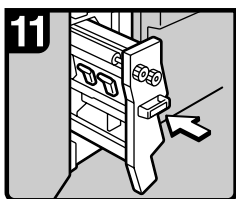

ZGVY890E

- Return the staple unit to its original position.
- Close the finisher front cover.



## Finisher 3000B (100-Sheet Staples)

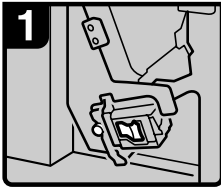

ZGVY1300E

- Open the finisher front cover.

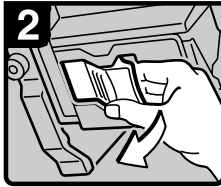

ZGVY1400E

- Pull out the cartridge lever.

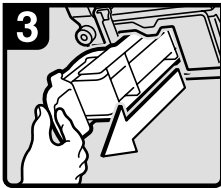

ZGVY1500E

- Pull out the cartridge.

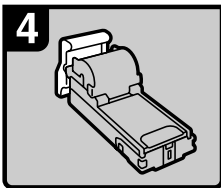

ZGVY1600E

- Put the cartridge down on a level surface.

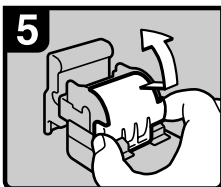

ZGVY1700E

- Raise the cover up.

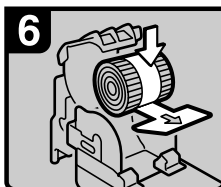

ZGVY1800E

- Set the new refill.

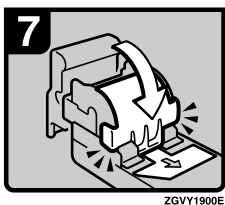

- Lower the cover until it clicks.

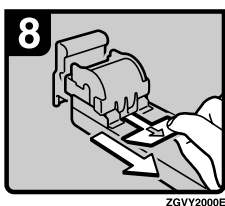

- Pull out the ribbon.

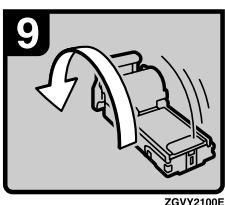

- Turn the cartridge around.

7

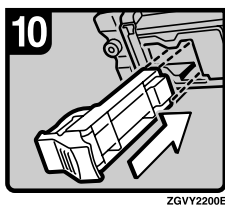

- Reinstall the cartridge.

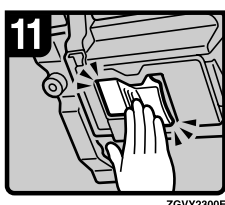

- Push the cartridge in until it clicks.

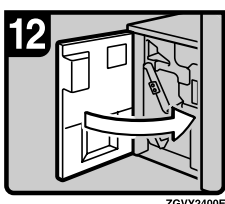

- Close the finisher front cover.

# Removing Jammed Staples

## Important

- ❑ A paper jam will occur if the machine staples using the booklet finisher without the saddle stitch stapler cartridge. Make sure the cartridge is set.

## Note

- ❑ Staples might jam due to curled copy paper. If this happens, try turning the paper over in the tray. If there is no improvement, change to a stiffer paper.
- ❑ When removing jammed staples, staples might not be ejected the first few times you try to use the stapler.

## Booklet Finisher

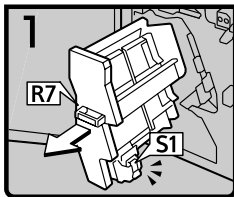

ZGVY900E

- Open the finisher front cover.
- Pull out the staple unit.

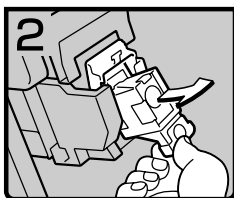

ZGVY910E

- Gently pull out the cartridge.

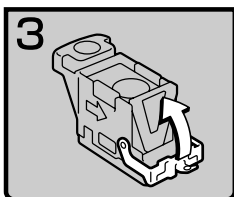

ZGVY920E

- Open the face plate.

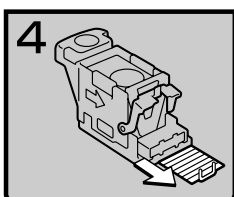

ZGVY930E

- Remove jammed staples.

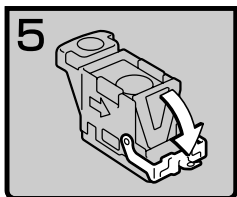

ZGVY940E

- Pull down the face plate of the cartridge until it clicks.

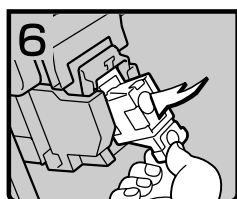

ZGVY950E

- Push the cartridge down until it clicks.

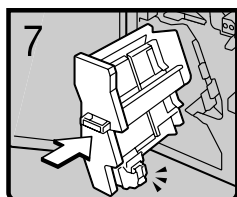

ZGVY960E

- Return the staple unit to its original position.
- Close the finisher front cover.

7

## Booklet Finisher (Saddle Stitch)

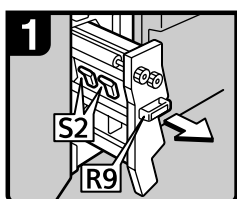

ZGVY970E

- Open the finisher front cover.
- Pull out the staple unit.

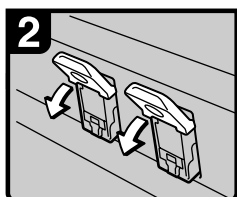

ZGVY980E

- Pull lever S2.

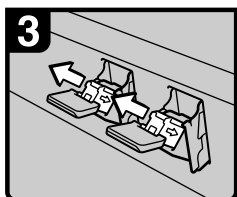

ZGVY990E

- Gently pull out the cartridge.

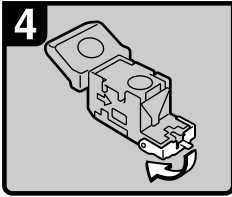

ZGVY1000E

- Open the face plate of the cartridge.

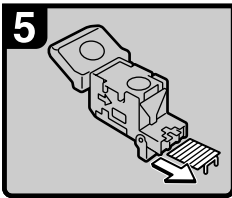

ZGVY1010E

- Remove jammed staples.

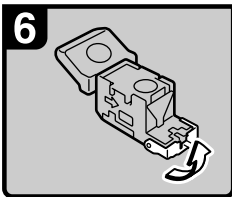

ZGVY1020E

- Pull the face plate of the cartridge down until it clicks.

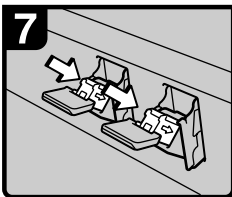

ZGVY1030E

- Push the cartridge down until it clicks.

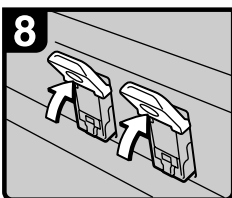

ZGVY1040E

- Return lever S2 to its original position.

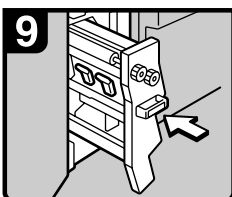

ZGVY1050E

- Return the staple unit to its original position.
- Close the front cover of the finisher.

## Finisher 3000B (100-Sheet Staples)

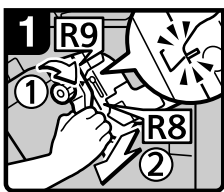

- Open the finisher front cover.
- Turn knob R9 until the markings align.
- Pull lever R8 and pull the staple unit completely out.

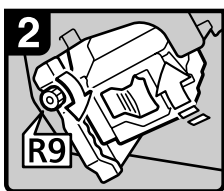

- Turn knob R9 to rotate the staple unit.

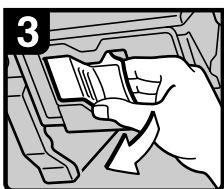

- Pull out the cartridge lever.

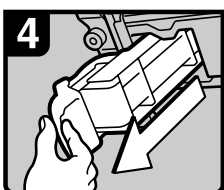

- Pull out the cartridge.

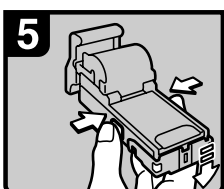

- Push the buttons on the both sides of the cartridge and open the face plate.

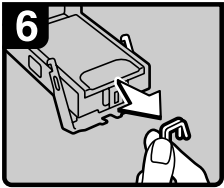

ZGVY3000E

- Remove jammed staples.

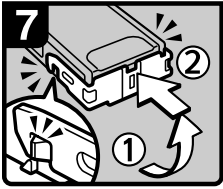

ZGVY3100E

- Lower the face plate until it clicks.

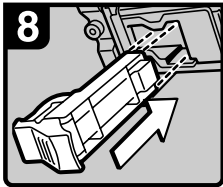

ZGVY3200E

- Reinstall the cartridge.

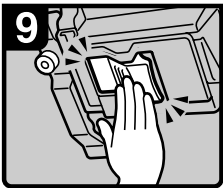

ZGVY3300E

- Push the cartridge in until it clicks.

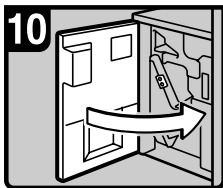

ZGVY3400E

- Close the finishers front cover.

## Removing Punch Waste

### Note

- ❑ When the "Hole punch receptacle is full." message appears, you cannot use the Punch function.

The procedures shown below is an example using the Finisher 3000B.

- 1** Open the finisher's front cover.

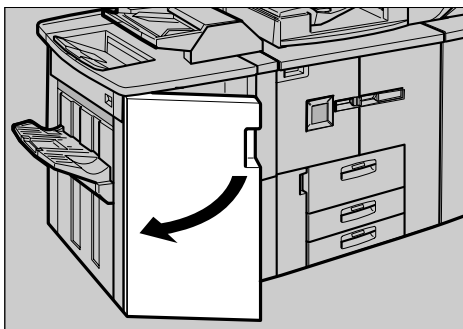

ZJBP020E

- 2** Pull out the punch waste box, and then remove punch waste.

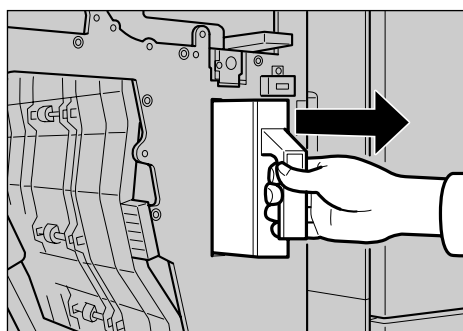

ZAKP020E

- 3** Reinstall the punch waste box.

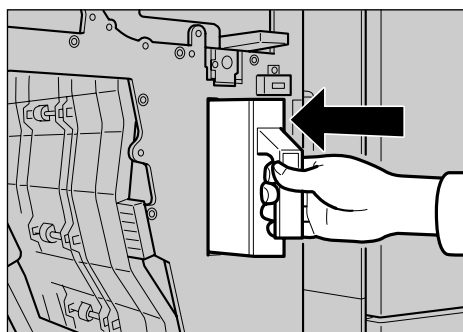

ZAKP030E



**4** Close the front cover of the finisher.

The “Hole punch receptacle is full.” message disappears.

 **Note**

- If the message is still displayed, reinstall the punch waste box.



## Do's and Don'ts

### **CAUTION:**

- *Unplug the power cord from the wall outlet before you move the machine. While moving the machine, you should take care that the power cord will not be damaged under the machine.*
- Do not turn off the main power switch while the On indicator is lit or blinking. This may cause damage to the hard disk or memory.
- Do not touch areas on or around the fusing unit. These areas get hot.
- After making copies continuously, the exposure glass may become warm—this is not a malfunction.
- When you use this machine for a long time in a confined space without good ventilation, you may detect an odd smell. To keep the workplace comfortable, we recommend that you keep it well ventilated.
- The area around the ventilation hole may become warm. This is caused by exhaust air and is not a malfunction.
- Do not turn off the operation switch while copying or printing. Make sure all copying or printing has finished.
- The machine might fail to produce good copy images if condensation forms inside due to rapid temperature change.
- Do not open the covers of the machine while copying or printing. If you do, misfeeds might occur.
- Do not move the machine while copying or printing.
- If you operate the machine improperly or a failure occurs, settings might be lost. Be sure to make a note of your machine settings.
- The manufacturer shall not be liable for any loss or damage resulting from failure of the machine, loss of settings, or use of the machine.

# Toner

---

## Handling Toner

---

 **WARNING:**

- *Do not incinerate used toner or toner containers. Toner dust might ignite when exposed to an open flame. Dispose of used toner containers in accordance with local regulations.*

 **CAUTION:**

- *Keep toner (used or unused) and toner containers out of reach of children.*

 **CAUTION:**

- *Our products are engineered to meet high standards of quality and functionality, and we recommend that you use only the expendable supplies available at an authorized dealer.*

 **Important**

- If you use toner other than the recommended type, an error might occur.

 **Reference**

If you want to add toner, see p.111 “ Adding Toner”.

---

## Toner Storage

---

When storing toner, the following precautions should always be followed:

- Store toner containers in a cool, dry place free from direct sunlight.
- Store on a flat surface.

---

## Used Toner

---

 **Note**

- Toner cannot be re-used.

---

# Where to Put Your Machine

---

---

## Machine Environment

---

Your machine's location should be carefully chosen because environmental conditions greatly affect its performance.

---

---

### Optimum environmental conditions

---

**⚠ CAUTION:**

- *Keep the machine away from humidity and dust. Otherwise a fire or an electric shock might occur.*
- *Do not place the machine on an unstable or tilted surface. If it topples over, an injury might occur.*

**⚠ CAUTION:**

- *If you use the machine in a confined space, make sure there is a continuous air turnover.*

- Temperature: 10 – 32°C (50 – 89.6°F)(humidity to be 54% at 32°C, 89.6°F)
- Humidity: 15 – 80% (temperature to be 27°C, 80.6°F at 80%)
- A strong and level base.
- The machine must be level within 5 mm, 0.2" both front to rear and left to right.
- To avoid possible buildup of ozone, be sure to locate this machine in a large well ventilated room that has an air turnover of more than 30 m<sup>3</sup>/hr/person.

---

### Environments to avoid

---

- Areas exposed to direct sunlight or strong light (more than 1,500 lux).
- Areas directly exposed to cool air from an air conditioner or heated air from a heater. (Sudden temperature changes might cause condensation withinside the machine.)
- Areas around machines generating ammonia such as a diazo copy machine.
- Places where the machine might be subjected to frequent strong vibration.
- Dusty areas.
- Areas with corrosive gases in the atmosphere.

---

## Moving

---

**⚠ CAUTION:**

- *Unplug the power cord from the wall outlet before you move the machine. While moving the machine, you should take care that the power cord will not be damaged under the machine.*

**🔊 Important**

- When moving the machine, the following precautions should always be followed:
  - Turn off the main power. See p.25 “Turning Off the Main Power”.
  - Unplug the power cord from the wall outlet. When you do, grip the plug to avoid damaging the cord and causing fire or electric shock.
  - Close all covers and trays including the front cover and multi bypass tray (Tray 7).

**🔇 Limitation**

- Move the machine carefully. If you do not, the machine might be damaged or a stored file might be deleted.
- Protect the machine from impacts. Shock could damage the hard disk and cause stored files to be deleted. As a precautionary measure, files should be copied to another local computer.

---

## Power Connection

---

**⚠ WARNING:**

- ***Connect the machine only to the power source described on the inside front cover of this manual. Connect the power cord directly into a wall outlet and do not use an extension cord.***
- ***Do not damage, break or make any modifications to the power cord. Do not place heavy objects on it. Do not pull it hard nor bend it more than necessary. These actions could cause an electric shock or fire.***

**⚠ CAUTION:**

- *Unplug the power cord from the wall outlet before you move the machine. While moving the machine, you should take care that the power cord will not be damaged under the machine.*

**⚠ CAUTION:**

- *When you disconnect the power plug from the wall outlet, always pull the plug (not the cable).*

- When the main power switch is in the Stand-by position, the optional anti-condensation heaters are on. In case of emergency, unplug the machine's power cord.
- When you unplug the power cord, the anti-condensation heaters turn off.
- Make sure that the plug is firmly inserted in the outlet.
- Voltage must not fluctuate by more than 10%.
- The socket-outlet should be installed near the equipment and be easily accessible.

## Access to the Machine

Position the machine near the power source, providing clearance as shown.

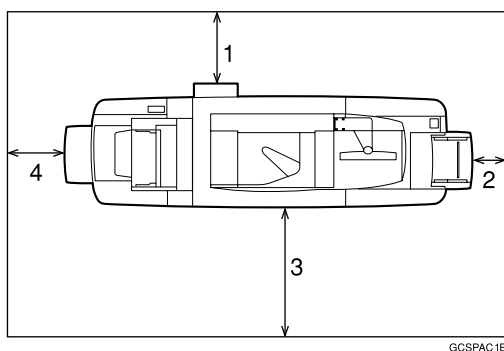

GCSPAC1E

- 1. Rear: more than 20 cm (7.8")**
- 2. Right: more than 3 cm (1.1")**
- 3. Front: more than 55.5 cm (21.6")**
- 4. Left: more than 40 cm (15.7")**

### Note

- For the required space when options are installed, contact your service representative.

# Maintaining Your Machine

If the exposure glass or ADF is dirty, you might not be able to make clear copies. Clean these parts if they become dirty.

◆ **Cleaning the machine**

Wipe the machine with a soft, damp cloth. Then, wipe it with a dry cloth to remove the water.

⚠ **Important**

- ❑ Do not use chemical cleaners or organic solvents, such as thinners or benzene. If they get into the machine or melt plastic parts, a failure might occur.
- ❑ Do not clean parts other than those specified in this manual. Such parts should be cleaned by a service representative.

---

## Cleaning the Exposure Glass

---

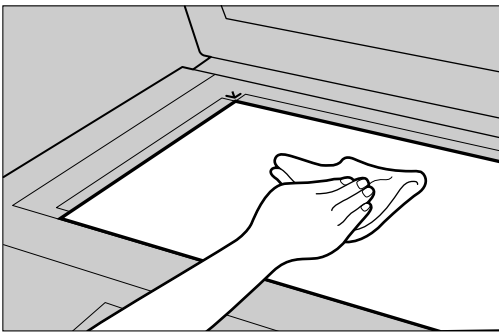

ND1C0200

---

## Cleaning the Auto Document Feeder

---

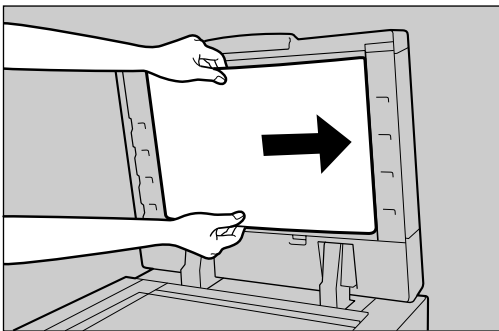

A1P0100E



# Other Functions

## Inquiry

The inquiry function lets you confirm the telephone numbers to contact for repairs or order toner. Be sure to contact your service engineer to verify the following:

- ❖ **Machine Maintenance/Repair**
  - Telephone No.
  - Serial No. of the machine
- ❖ **Sales Representative**
  - Telephone No.

**1** Press the **[Counter]** key.

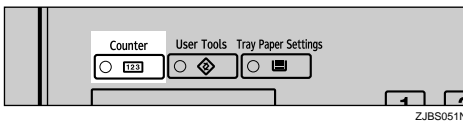

Inquiry information is displayed.

### Printing inquiry information

**1** Press **[Print Inquiry List]**.

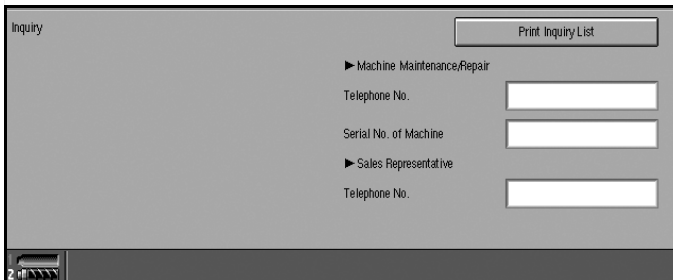

**2** Press the **[Start]** key.

Inquiry information is printed.

**2** Press **[Exit]**.

## Changing the Display Language

You can change the language used on the display. English is set as the default.

**1** Press the **[Language Selection]** key.

 **Note**

- If you want to return the display language to “English”, repeat step **1** and press **[English]**.

## Counter

### Displaying the total counter

You can display the total number of sheets used for all functions and the total number of sheets used for copying.

You can also print the counter list.

**1** Press the **[Counter]** key.

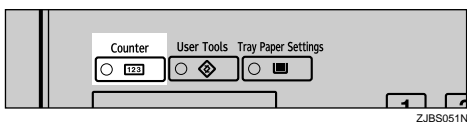

**2** To print a counter list, press **[Print Counter List]**.

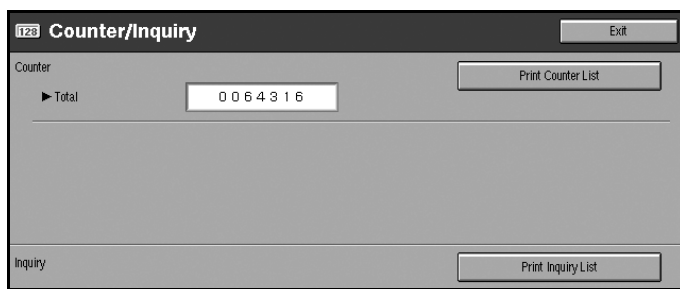

**3** Press the **[Start]** key.

A counter list is printed.

## Security

Confidential information is always at risk of being copied without permission or subject to unauthorized access through the network. To protect documents from these types of risks, not only can passwords be set, but also the Extended Security function can be used to strengthen security.

For those who require ample document protection, we recommend that the Extended Security function be used.

---

### Primary Security Functions

---

#### ❖ Protecting Stored Documents

Protects documents with a password when using Document Server or Locked Print. Furthermore, the Extended Security function can protect against a password-guessing attack. See p.149 “Extended Security Function”.

#### ❖ Protecting Image Data Remaining in Memory

Protects image data remaining in memory. When a copying or printing job is completed or a job is cancelled, the data is secure.

#### ❖ Authenticating Administrator

Protects essential functions for administrating document security with an access code. See p.69 “Key Operator Code”

---

### Extended Security Function

---

By setting a password, operations with documents such as printing, deleting, or delivering can be restricted to authorized users and access denied to others. However, a password is breakable. When the Extended Security function is used, entering the wrong password 10 times will lock a document, protecting it from illegitimate accesses.

For unlocking documents, see p.150 “Unlocking a Locked Document”.

The documents that can be protected by the Extended Security function are as follows. All documents must be set with a password to be protected by this function.

#### ❖ Documents stored in the Document Server by the following functions

- Document Server mode
- Copier function
- Scanner function
- Printer driver

**◆ Documents stored from the printer driver using Lock Print function** **Reference**

For information about Document Server, see p.35 “Document Server”.

For information about Locked Print, see “Locked Print”, *Printer Reference*, or the printer driver Help.

 **Note**

- Once a document has been locked, it will not accept even the correct password until it is unlocked.
- When Extended Security function is on, settings for the delivery server cannot be changed. Turn the function off when changing the settings.

---

**Setting Extended Security**

---

 **Preparation**

The Extended Security setting is not available unless the access code set in the Access Code settings of the System Settings is six or more digits. See p.69 “Key Operator Code”.

**1** Press the **[User Tools/Counter]** key.

**2** On the display panel, press **[System Settings]**, and then press **[Key Operator Tools]**.

**3** Press **[Extended Security]**. Press **[On]**, and then **[OK]**.

The Extended Security function is enabled and the security mark  appears at the lower right of the display panel.

**4** Press the **[User Tools/Counter]** key to finish.

---

**Unlocking a Locked Document**

---

Unlock a document that was locked due to entering the wrong password multiple times and make it available for authorized users to access again.

**1** Press the **[User Tools/Counter]** key.

**2** On the display panel, press **[System Settings]**, and then press **[Password Management for Stored Files]**.

**3** Press **[OK]** under **[Unlock Files]**.

The document is unlocked.

**4** Press the **[User Tools/Counter]** key to finish.

---

## Temporarily Disabling Document Security

---

In the event you forget a password, document protection can be temporarily disabled, making documents available for operations such as setting new passwords or deleting.

### Important

- After operations are complete, be sure to press “Do not Unlock” under “Temporarily Unlock Files”, making the document protected by password again.

### Note

- For a document stored using Locked Print, only document deletion is available while protection is disabled.

**1** Press the **[User Tools/Counter]** key.

**2** On the display panel, press **[System Settings]**, and then press **[Password Management for Stored Files]**.

**3** Press **[Unlock]** under “Temporarily Unlock Files”.

### Note

- Protection can be disabled for only three minutes. Access the document, set a new password, and perform any other necessary operations to the document within that time. Documents will automatically return to the password-protected condition after three minutes.

**4** Press the **[User Tools/Counter]** key to finish.

# Operating Environment and Notes

Security for this machine is assured on the premises that the machine is used under the following conditions:

---

## Operating Environment

---

- The condition of the machine is normal. (For example, it is not damaged, modified, or lacking components.)
- When the machine is connected to a network, the machine is protected from illegitimate access including unauthorized packet sniffing.
- The machine is managed by an administrator with thorough knowledge of the machine and capable of providing the proper conditions under which users can use the machine safely.

---

## For Administrator

---

- This machine does not protect against illegitimate actions on the network. To avoid any risks on the network, further security is required.
- Security of this machine cannot be assured if any hardware component is detached or replaced with an inappropriate component. If these things have the possibility of occurring, other security measures are necessary.
- Regularly check that the Extended Security function is on. While the machine is in this mode, the security mark  is displayed at the lower right of the display panel. Be sure to check it particularly after the machine is moved or a power failure occurs. See p.150 "Setting Extended Security".
- Avoid using a single number or consecutive numbers for an access code such as "00000000" or "12345678". Since the numbers like this are easy to guess, using them will not provide the appropriate level of security.
- Remote document management using SmartNetMonitor for Admin is not available when the Extended Security function is on.
- User code is a function to help manage the use of the machine. It is not to protect confidential documents from others. See p.75 "User Codes".
- As for using the delivery function, the security of this machine can assure only the protection of documents having a password set and stored in the Document Server. Be sure to select the destination correctly when delivering documents.

---

## For User

---

- Be careful not to let anyone know your password, especially when entering a password or recording it. Keep any record of your password in a safe place.
- Avoid using a single number or consecutive numbers for a password such as “0000” or “1234”. Since the numbers like this are easy to guess, using them will not provide the appropriate level of security.
- A document accessed with a correct password remains selected even after operations are completed and can be accessed by other users. To avoid this, be sure to press the **【Clear Modes】** key to cancel the selection of the document.
- The user name that is used when adding a document to the Document Server is to identify the document creator and type. It is not to protect confidential documents from others.
- Before scanning documents using the scanner function, make sure that all other operations are completed.





# 10. Specification

## Main Machine

- ❖ **Configuration:**  
Console
- ❖ **Photosensitivity type:**  
OPC drum (Ø100)
- ❖ **Original scanning:**  
One-dimensional solid scanning system through CCD
- ❖ **Copy process:**  
Dry electrostatic transfer system
- ❖ **Development:**  
Dry two-component magnetic brush development system
- ❖ **Fusing:**  
Heating roll pressure system
- ❖ **Resolution:**  
1200 dpi
- ❖ **Exposure glass:**  
Stationary original exposure type
- ❖ **Original reference position:**  
Rear left corner
- ❖ **Warm-up time:**  
Less than 360 seconds (23°C)
- ❖ **Originals:**  
Sheet/Book/Objects
- ❖ **Original size:**  
A3☐ - A5☐☐, 11" × 17"☐ - 5<sup>1</sup>/<sub>2</sub>" × 8<sup>1</sup>/<sub>2</sub>" ☐☐
- ❖ **Copy paper size:**  
See p.170 "Copy Paper" about paper size for each tray
- ❖ **Copy paper weight:**
  - Tray 1 - Tray 3, Tray 6 : 52 - 162 g/m<sup>2</sup>, 16 lb. Bond - 90 lb. Index
  - Tray 4, Tray 5, Tray 7: 52 - 216 g/m<sup>2</sup>, 16 lb. Bond - 80 lb. Cover









❖ **Non-reproduction area:**

- Leading edge: More than  $4 \pm 2$  mm
- Trailing edge: More than  $2 + 2 / -1.7$  mm
- Left edge: More than  $2 \pm 1.5$  mm
- Right edge: More than  $2 \pm 1.5$  mm

❖ **First copy time:**

Type 1	3.5 seconds (for Face Up) 5 seconds (for Face Down)
Type 2	3.2 seconds (for Face Up) 4.5 seconds (for Face Down)

❖ **Copying speed:**

Type 1	90 copies/minute (A4  , 8 1/2" x 11"  )	41 copies/minute (A3  )	42 copies/minute (11" x 17"  )
Type 2	105 copies/minute (A4  , 8 1/2" x 11"  )	49 copies/minute (A3  )	51 copies/minute (11" x 17"  )

❖ **Reproduction ratio:**

Preset reproduction ratios:

	Metric version	Inch version
Enlargement	400 %	400 %
	200 %	200 %
	141 %	155 %
	122 %	129 %
	115 %	121 %
Full Size	100 %	100 %
Reduction	93 %	93 %
	82 %	85 %
	75 %	78 %
	71 %	73 %
	65 %	65 %
	50 %	50 %
	25 %	25 %

Zoom: From 25 % to 400 % in 1 % steps.

❖ **Maximum number of continuous copy sets**

1 – 9999 copies

❖ **Copy paper capacity:**

- Tray 1 (Tandem tray) : 2,200 sheets (1,100 sheets × 2) (80 g/m<sup>2</sup>, 20 lb Bond)
- Tray 2 (550-sheet tray) : 550 sheets (80 g/m<sup>2</sup>, 20 lb Bond)
- Tray 3 (550-sheet tray) : 550 sheets (80 g/m<sup>2</sup>, 20 lb Bond)
- Tray 4 (LCT): 1,000 sheets (80 g/m<sup>2</sup>, 20 lb Bond)
- Tray 5 (LCT): 1,000 sheets (80 g/m<sup>2</sup>, 20 lb Bond)
- Tray 6 (LCT): 2,550 sheets (80 g/m<sup>2</sup>, 20 lb Bond)
- Tray 7: 500 sheets (80 g/m<sup>2</sup>, 20 lb Bond)

❖ **Power consumption (Type 1: 90 copies/minute model):**

	Main machine only	Full system <sup>*1</sup>
Warm-up	2.2 kW	2.3 kW
Stand-by	0.65 kW	0.7 kW
Copying	2.7 kW	2.8 kW
Maximum	2.8 kW	2.9 kW

<sup>\*1</sup> Main machine with the finisher, LCT, Multi bypass tray (Tray 7), ADF, interposer

❖ **Power consumption (Type 2: 105copies/minute model):**

	Main machine only	Full system <sup>*1</sup>
Warm-up	2.2 kW	2.3 kW
Stand-by	0.65 kW	0.7 kW
Copying	2.8 kW	2.9 kW
Maximum	2.9 kW	3.0 kW

<sup>\*1</sup> Main machine with the finisher, LCT, Multi bypass tray (Tray 7), ADF, interposer

❖ **Dimensions (W × D × H up to exposure glass):**

2,096 × 858.5 × 1,476 mm, 82.5" × 33.78" × 58.1"

❖ **Space for main machine (W × D):**

- 1,202 × 858.5 mm, 47.3" × 33.78" (ADF external extender is not used, optional output tray is installed.)
- 2,218 × 858.5 mm, 87.3" × 33.78" (ADF external extender is used for larger size originals, optional finisher proof tray is installed.)
- 2,314 × 858.5 mm, 91.1" × 33.78" (ADF external extender is used for larger size originals, optional finisher proof tray is installed.)

❖ **Noise emission \*1 (Type 1):**

Sound power level

	Main machine only	Complete system *3
When printing	74 dB (A)	78 dB (A)
Stand-by	60 dB (A)	59 dB (A)

Sound pressure level \*2

	Main machine only	Complete system *3
During printing	60 dB (A)	68 dB (A)
Stand-by	45 dB (A)	46 dB (A)

\*1 The above measurements are ISO 7779 actual values.

\*2 Measured at the position of the bystander/operator. During printing.

\*3 Main machine with full options.

❖ **Noise emission \*1 (Type 2):**

Sound power level

	Main machine only	Complete system *3
When printing	76 dB (A)	79 dB (A)
Stand-by	60 dB (A)	59 dB (A)

Sound pressure level \*2

	Main machine only	Complete system *3
During printing	61 dB (A)	68 dB (A)
Stand-by	45 dB (A)	46 dB (A)

\*1 The above measurements are ISO 7779 actual values.

\*2 Measured at the position of the bystander/operator. During printing.

\*3 Main machine with full options.

❖ **Weight:**

Approx. 270 kg, 594 lb (main machine with the ADF)

---

## Document Server

---

- ❖ **HDD:**  
80 GB
  - ❖ **HDD (Document Server):**  
45 GB
  - ❖ **Capacity:**
    - Copy: Approx. 3,000 (ITUT-No.4 chart)
    - Batch mode: Approx. 3,000 (ITUT-No.4 chart)
    - Printer: Approx. 15,000 (600 dpi)
    - Scanner: Approx. 3,000 (200 dpi/Text) (ITUT-No.4 chart) <sup>\*1</sup>
  - ❖ **Maximum number of stored documents:**  
3,000
  - ❖ **Maximum pages of stored documents:**  
15,000
  - ❖ **Maximum number of pages per document:**  
2,000
  - ❖ **Capacity (Memory Sorting):**  
6.75 GB (A4/8<sup>1</sup>/<sub>2</sub>" × 11" : Approx. 333 sheets-3000 sheets at maximum) <sup>\*2</sup>
  - ❖ **Capacity (Others):**  
10.0 GB
- <sup>\*1</sup> Scanning Condition: ITUT-No.4 chart/200 dpi/Text/A4/MMR  
<sup>\*2</sup> The capacity will change when the multiple functions are used.

---







## Auto Document Feeder

---

❖ **Mode:**

ADF mode, Batch mode, SADF mode, Mixed Sizes mode, Thin mode

❖ **Original size:**

- A3  - A5  
- 11" × 17"  - 8 1/2" × 5 1/2"  



❖ **Original weight:**

- 1-sided originals: 52 - 156 g/m<sup>2</sup> (14 - 42 lb. Bond)
- 2-sided originals: 52 - 128 g/m<sup>2</sup> (14 - 34 lb. Bond) (Duplex)
- Thin paper mode: 40 - 156 g/m<sup>2</sup> (11 - 42 lb. Bond)

❖ **Number of originals that can be set:**

100 sheets (80 g/m<sup>2</sup>, 20 lb. Bond) of less than 12 mm, 0.5"

❖ **Copying speed:**

80 copies/minute (A4 , 8 1/2" × 11" , 1 to 1 copying)

❖ **Power Source:**

Supplied from the main machine.

 **Note**

-  Specifications are subject to change without notice.

# Options

## Booklet Finisher

### Finisher Upper Tray:

#### ❖ Paper size:

A3☐, B4☐, A4☐☐, B5☐☐, A5☐☐, 11" × 17"☐, 8<sup>1</sup>/<sub>2</sub>" × 14"☐, 8<sup>1</sup>/<sub>2</sub>" × 11"☐☐, 5<sup>1</sup>/<sub>2</sub>" × 8<sup>1</sup>/<sub>2</sub>"☐☐, 12" × 18"☐

#### ❖ Paper weight:

52 – 163 g/m<sup>2</sup>, 14 – 43 lb. Bond

#### ❖ Stack capacity:

- 250 sheets (A4☐☐, B5☐☐, A5☐☐, 8<sup>1</sup>/<sub>2</sub>" × 11"☐☐, 5<sup>1</sup>/<sub>2</sub>" × 8<sup>1</sup>/<sub>2</sub>"☐☐) (80 g/m<sup>2</sup>, 20 lb. Bond)
- 50 sheets (A3☐, B4☐, 11" × 17"☐, 8<sup>1</sup>/<sub>2</sub>" × 14"☐, 12" × 18"☐) (80 g/m<sup>2</sup>, 20 lb. Bond)

### Finisher Shift Tray 1:

#### ❖ Paper size:

A3☐, B4☐, A4☐☐, B5☐☐, A5☐☐, 11" × 17"☐, 8<sup>1</sup>/<sub>2</sub>" × 14"☐, 8<sup>1</sup>/<sub>2</sub>" × 11"☐☐, 5<sup>1</sup>/<sub>2</sub>" × 8<sup>1</sup>/<sub>2</sub>"☐☐, 12" × 18"☐

#### ❖ Paper weight:

52 – 216 g/m<sup>2</sup>, 14 – 58 lb. Bond

#### ❖ Stack capacity:

- 500 sheets (A4☐☐, B5☐☐, A5☐☐, 8<sup>1</sup>/<sub>2</sub>" × 11"☐☐) (80 g/m<sup>2</sup>, 20 lb. Bond)
- 250 sheets (A3☐, B4☐, 11" × 17"☐, 8<sup>1</sup>/<sub>2</sub>" × 14"☐, 12" × 18"☐) (80 g/m<sup>2</sup>, 20 lb. Bond)
- 100 sheets (A5☐☐, 5<sup>1</sup>/<sub>2</sub>" × 8<sup>1</sup>/<sub>2</sub>"☐☐) (80 g/m<sup>2</sup>, 20 lb. Bond)

#### ❖ Staple paper size:

A3☐, B4☐, A4☐☐, B5☐☐, 11" × 17"☐, 8<sup>1</sup>/<sub>2</sub>" × 14"☐, 8<sup>1</sup>/<sub>2</sub>" × 11"☐☐

#### ❖ Staple paper weight:

64 – 90 g/m<sup>2</sup>, 17 – 28 lb. Bond

#### ❖ Staple capacity:

Without Mixed Size mode:





- 50 sheets (A4☐☐, B5☐☐, 8<sup>1</sup>/<sub>2</sub>" × 11"☐☐) (80 g/m<sup>2</sup>, 20 lb. Bond)
- 30 sheets (A3☐, B4☐, 11" × 17"☐, 8<sup>1</sup>/<sub>2</sub>" × 14"☐) (80 g/m<sup>2</sup>, 20 lb. Bond)

With Mixed Size mode:







- 30 sheets (A4☐ / A3☐, B5☐ / B4☐, 8<sup>1</sup>/<sub>2</sub>" × 11"☐ / 11" × 17"☐) (80 g/m<sup>2</sup>, 20 lb. Bond)

❖ **Stack capacity after stapling**

Without Mixed Size mode:

- 50–10 sets (10–50 sheets) (A4 , 8 1/2" × 11" ) (80 g/m<sup>2</sup>, 20 lb. Bond)
- 50 sets (2–9 sheets) (A4 , 8 1/2" × 11" ) (80 g/m<sup>2</sup>, 20 lb. Bond)
- 25–16 sets (10–30 sheets) (other paper size) (80 g/m<sup>2</sup>, 20 lb. Bond)
- 25 sets (2–9 sheets) (other paper size) (80 g/m<sup>2</sup>, 20 lb. Bond)

With Mixed Size mode:

- 16 sets (2–30 sheets) (A4  / A3 , B5  / B4 , 8 1/2" × 11"  / 11" × 17" ) (80 g/m<sup>2</sup>, 20 lb. Bond)

❖ **Staple position:**

4 position (Top, Top Slant, Bottom, 2 Staples)

Finisher Shift Tray 2:

















❖ **Paper size:**

A3 , B4 , A4  , B5  , A5  , 11" × 17" , 8 1/2" × 14" , 8 1/2" × 11"  , 5 1/2" × 8 1/2"  , 12" × 18"  











❖ **Paper weight:**

52 – 216 g/m<sup>2</sup>, 14 – 58 lb. Bond

❖ **Stack capacity:**

- 2,500 sheets (A4 , 8 1/2" × 11" ) (80 g/m<sup>2</sup>, 20 lb. Bond)
- 1,250 sheets (A3 , B4 , A4 , B5  , 11" × 17" , 8 1/2" × 14" , 8 1/2" × 11"  , 12" × 18"  ) (80 g/m<sup>2</sup>, 20 lb. Bond)
- 500 sheets (A5 ) (80 g/m<sup>2</sup>, 20 lb. Bond)
- 100 sheets (A5 , 5 1/2" × 8 1/2" ) (80 g/m<sup>2</sup>, 20 lb. Bond)

❖ **Staple paper size:**









A3 , B4 , A4  , B5  , 11" × 17" , 8 1/2" × 14" , 8 1/2" × 11"  

❖ **Staple paper weight:**







64 – 90 g/m<sup>2</sup>, 17 – 28 lb. Bond

❖ **Staple capacity:**

Without Mixed Size mode:

- 50 sheets (A4 , B5  , 8 1/2" × 11"  ) (80 g/m<sup>2</sup>, 20 lb. Bond)
- 30 sheets (A3 , B4 , 11" × 17" , 8 1/2" × 14" ) (80 g/m<sup>2</sup>, 20 lb. Bond)











With Mixed Size mode:

- 30 sheets (A4  / A3 , B5  / B4 , 8 1/2" × 11"  / 11" × 17" ) (80 g/m<sup>2</sup>, 20 lb. Bond)









### ❖ Stack capacity after stapling

Without Mixed Size mode:

- 250–50 sets (10–50 sheets) (A4 , 8 1/2" × 11" ) (80 g/m<sup>2</sup>, 20 lb. Bond)
- 250 sets (2–9 sheets) (A4 , 8 1/2" × 11" ) (80 g/m<sup>2</sup>, 20 lb. Bond)
- 125–25 sets (10–50 sheets) (A4 , B5 , 8 1/2" × 11" ) (80 g/m<sup>2</sup>, 20 lb. Bond)
- 125 sets (2–9 sheets) (A4 , B5 , 8 1/2" × 11" ) (80 g/m<sup>2</sup>, 20 lb. Bond)
- 125–40 sets (10–30 sheets) (other paper size) (80 g/m<sup>2</sup>, 20 lb. Bond)
- 125 sets (2–9 sheets) (other paper size) (80 g/m<sup>2</sup>, 20 lb. Bond)





With Mixed Size mode:

- 50 sets (2–30 sheets) (A4 , A3 , B5 , B4 , 8 1/2" × 11" , 11" × 17" ) (80 g/m<sup>2</sup>, 20 lb. Bond)

### ❖ Staple position:

4 position (Top, Top Slant, Bottom, 2 Staples)

### ❖ Saddle stitch paper size:

A3 , B4 , A4 , 11" × 17" , 8 1/2" × 11" 







### ❖ Saddle stitch paper weight:

64 – 90 g/m<sup>2</sup>, 17 – 28 lb. Bond

### ❖ Saddle stitch capacity:

1 set (15 sheets)

### ❖ Stack capacity after saddle stitching

- 25 sets (2–5 sheets) (A4 , 8 1/2" × 11" ) (80 g/m<sup>2</sup>, 20 lb. Bond)
- 15 sets (6–10 sheets) (A4 , 8 1/2" × 11" ) (80 g/m<sup>2</sup>, 20 lb. Bond)
- 10 sets (11–15 sheets) (A4 , 8 1/2" × 11" ) (80 g/m<sup>2</sup>, 20 lb. Bond)
- 30 sets (2–5 sheets) (other paper size) (80 g/m<sup>2</sup>, 20 lb. Bond)
- 20 sets (6–10 sheets) (other paper size) (80 g/m<sup>2</sup>, 20 lb. Bond)
- 10 sets (11–15 sheets) (other paper size) (80 g/m<sup>2</sup>, 20 lb. Bond)

### ❖ Saddle stitch position:

Center 2 position

### ❖ Power consumption:

Approx. 72 W (power is supplied from the mainframe)

### ❖ Dimensions (W × D × H):

700 × 620 × 960 mm, 27.6" × 24.5" × 37.8"

### ❖ Weight:

Approx. 62 kg, 136.7 lb.

### Note

- ❑ Specifications are subject to change without notice.

---

## Finisher 3000B (100-Sheet Staples)

---

### Finisher Upper Tray:

❖ **Paper size:**

A3, B4, A4, B5, A5, 11" × 17", 8<sup>1</sup>/<sub>2</sub>" × 14", 8<sup>1</sup>/<sub>2</sub>" × 11", 5<sup>1</sup>/<sub>2</sub>" × 8<sup>1</sup>/<sub>2</sub>", 12" × 18"

❖ **Paper weight:**

52 – 216 g/m<sup>2</sup>, 14 – 58 lb. Bond

❖ **Stack capacity:**

- 500 sheets (A4, B5, A5, 8<sup>1</sup>/<sub>2</sub>" × 11", 5<sup>1</sup>/<sub>2</sub>" × 8<sup>1</sup>/<sub>2</sub>) (80 g/m<sup>2</sup>, 20 lb. Bond)
- 250 sheets (A3, B4, 11" × 17", 8<sup>1</sup>/<sub>2</sub>" × 14", 12" × 18") (80 g/m<sup>2</sup>, 20 lb. Bond)

### Finisher Shift Tray:

❖ **Paper size:**

A3, B4, A4, B5, A5, 11" × 17", 8<sup>1</sup>/<sub>2</sub>" × 14", 8<sup>1</sup>/<sub>2</sub>" × 11", 5<sup>1</sup>/<sub>2</sub>" × 8<sup>1</sup>/<sub>2</sub>", 12" × 18"

❖ **Paper weight:**

52 – 216 g/m<sup>2</sup>, 14 – 58 lb. Bond

❖ **Stack capacity:**

- 3,000 sheets (A4, B5, 8<sup>1</sup>/<sub>2</sub>" × 11") (80 g/m<sup>2</sup>, 20 lb. Bond)
- 1,500 sheets (A3, B4, A4, B5, 11" × 17", 8<sup>1</sup>/<sub>2</sub>" × 14", 8<sup>1</sup>/<sub>2</sub>" × 11", 12" × 18") (80 g/m<sup>2</sup>, 20 lb. Bond)
- 500 sheets (A5, 5<sup>1</sup>/<sub>2</sub>" × 8<sup>1</sup>/<sub>2</sub>") (80 g/m<sup>2</sup>, 20 lb. Bond)
- 100 sheets (A5, 5<sup>1</sup>/<sub>2</sub>" × 8<sup>1</sup>/<sub>2</sub>") (80 g/m<sup>2</sup>, 20 lb. Bond)

❖ **Staple paper size:**

A3, B4, A4, B5, 11" × 17", 8<sup>1</sup>/<sub>2</sub>" × 14", 8<sup>1</sup>/<sub>2</sub>" × 11"















❖ **Staple paper weight:**

64 – 80 g/m<sup>2</sup>, 17 – 20 lb. Bond

❖ **Staple capacity:**

- 100 sheets (A4, B5, 8<sup>1</sup>/<sub>2</sub>" × 11") (80 g/m<sup>2</sup>, 20 lb. Bond)
- 50 sheets (A3, B4, 11" × 17", 8<sup>1</sup>/<sub>2</sub>" × 14") (80 g/m<sup>2</sup>, 20 lb. Bond)

### ❖ Stack capacity after stapling

- 200–30 sets (10–100 sheets) (A4 , B5 , 8<sup>1</sup>/<sub>2</sub>" × 11" ) (80 g/m<sup>2</sup>, 20 lb. Bond)
- 150 sets (2–9 sheets) (A4 , B5 , 8<sup>1</sup>/<sub>2</sub>" × 11" ) (80 g/m<sup>2</sup>, 20 lb. Bond)
- 150–30 sets (10–50 sheets) (A3 , B4 , 11" × 17" , 8<sup>1</sup>/<sub>2</sub>" × 14" ) (80 g/m<sup>2</sup>, 20 lb. Bond)
- 150 sets (2–9 sheets) (A3 , B4 , 11" × 17" , 8<sup>1</sup>/<sub>2</sub>" × 14" ) (80 g/m<sup>2</sup>, 20 lb. Bond)

### ❖ Staple position:

4 position (Top, Top Slant, Bottom, 2 Staples)

### ❖ Power consumption:

Approx. 100 W (supplied from the main machine)

### ❖ Dimensions (W × D × H):

800 × 730 × 980 mm, 31.5" × 28.7" × 38.6"

### ❖ Weight:

Approx. 65 kg, 143.3 lb.

### Note

- ❑ Specifications are subject to change without notice.

## Large Capacity Tray

### ❖ Paper size:

See p.170 "Copy Paper" about paper size for tray 4, 5, and 6.

### ❖ Paper weight:

Tray 4, 5: 52 – 216 g/m<sup>2</sup>, 16 – 18 lb. Bond

Tray 6: 52 – 163 g/m<sup>2</sup>, 16 – 90 lb. Bond

### ❖ Paper capacity:

Tray 4, 5: 1,000 sheets (80 g/m<sup>2</sup>, 20 lb. Bond)

Tray 6: 2,550 sheets (80 g/m<sup>2</sup>, 20 lb. Bond)

### ❖ Power consumption

85 W or less (supplied from the main machine)

### ❖ Dimensions (W × D × H, option unit):

540 × 730 × 980 mm, 21.3" × 28.8" × 38.6"

### ❖ Weight:

Approx. 82 kg (180 lb) or less

### Note

- ❑ Specifications are subject to change without notice.

---

## Multi Bypass Tray (Tray 7)

---

❖ **Paper size:**

See p.170 "Copy Paper" about paper size for multi bypass tray (tray 7).

❖ **Paper weight:**

52 - 216 g /m<sup>2</sup>, 16 lb. Bond - 80 lb. Cover

❖ **Paper capacity:**

500 sheets (80 g/m<sup>2</sup>, 20 lb Bond)

❖ **Power consumption:**

75 W or less (supplied from the main machine)

❖ **Dimensions (W × D × H):**

680 × 561 × 181 mm, 26.8" × 22.1" × 7.2"

❖ **Weight:**

Approx. 18 kg (39.7 lb) or less

 **Note**









Specifications are subject to change without notice.

---

## Interposer

---

❖ **Paper size:**

A3 , B4 , A4 , B5 , A5 , 11" × 17" , 8 1/2" × 14" , 8 1/2" × 11" , 5 1/2" × 8 1/2" 

❖ **Paper weight:**

64 – 216 g/m<sup>2</sup>, 20 – 58 lb. Bond

❖ **Paper capacity:**

200 sheets (80 g/m<sup>2</sup>, 20 lb. Bond)

❖ **Power consumption (Max):**

Approx. 48 W (supplied from the main machine)

❖ **Dimensions (W × D × H):**

500 × 620 × 200 mm, 19.7" × 24.4" × 7.9"

❖ **Weight:**

Approx. 12 kg, 26.5 lb.











 **Note**

Specifications are subject to change without notice.

## Punch Unit

Booklet Finisher:

### ❖ Paper size:

Punch unit type			
2 & 4 holes type	2 holes		A3-A5, 11" × 17"-5 <sup>1</sup> / <sub>2</sub> " × 8 <sup>1</sup> / <sub>2</sub> "
			A4-A5, 8 <sup>1</sup> / <sub>2</sub> " × 11", 5 <sup>1</sup> / <sub>2</sub> " × 8 <sup>1</sup> / <sub>2</sub> "
	4 holes		A3, B4, 11" × 17"
			A4, B5, 8 <sup>1</sup> / <sub>2</sub> " × 11"
4 holes type	4 holes		A3-A5, 11" × 17"-5 <sup>1</sup> / <sub>2</sub> " × 8 <sup>1</sup> / <sub>2</sub> "
			A4-A5, 8 <sup>1</sup> / <sub>2</sub> " × 11", 5 <sup>1</sup> / <sub>2</sub> " × 8 <sup>1</sup> / <sub>2</sub> "
2 & 3 holes type	2 holes		A3-A5, 11" × 17"-5 <sup>1</sup> / <sub>2</sub> " × 8 <sup>1</sup> / <sub>2</sub> "
			A4-A5, 8 <sup>1</sup> / <sub>2</sub> " × 11", 5 <sup>1</sup> / <sub>2</sub> " × 8 <sup>1</sup> / <sub>2</sub> "
	3 holes		A3, B4, 11" × 17"
			A4, B5, 8 <sup>1</sup> / <sub>2</sub> " × 11"

### ❖ Paper weight:

52 – 163 g/m<sup>2</sup>, 14 lb. – 43 lb. Bond

### ❖ Power consumption:

26.4 W (supplied from the main machine)

### ❖ Dimensions (W × D × H):













142 × 456 × 92 mm, 55.9" × 179.5" × 36.2"

### ❖ Weight:

Approx. 2.9 kg, 6.4 lb

Finisher 3000B (100-Sheet Staples):

❖ **Paper size:**

Punch unit type			
2 holes type (metric version)	2 holes		A3-A5, 11" × 17"-5 <sup>1</sup> / <sub>2</sub> " × 8 <sup>1</sup> / <sub>2</sub> "
			A4-A5, 8 <sup>1</sup> / <sub>2</sub> " × 11", 5 <sup>1</sup> / <sub>2</sub> " × 8 <sup>1</sup> / <sub>2</sub> "
4 holes type (metric version)	4 holes		A3, 11" × 17"
			A4, 8 <sup>1</sup> / <sub>2</sub> " × 11"
2 & 4 holes type (metric version)	4 holes		A3-B5, 11" × 17"-8 <sup>1</sup> / <sub>2</sub> " × 11"
			A4-A5, 8 <sup>1</sup> / <sub>2</sub> " × 11", 5 <sup>1</sup> / <sub>2</sub> " × 8 <sup>1</sup> / <sub>2</sub> "
4 holes type (narrow 2 × 2 version)	4 holes		A3-A5, 11" × 17"-5 <sup>1</sup> / <sub>2</sub> " × 8 <sup>1</sup> / <sub>2</sub> "
			A4-A5, 8 <sup>1</sup> / <sub>2</sub> " × 11", 5 <sup>1</sup> / <sub>2</sub> " × 8 <sup>1</sup> / <sub>2</sub> "
2 holes type (inch version)	2 holes		A3-A5, 11" × 17"-5 <sup>1</sup> / <sub>2</sub> " × 8 <sup>1</sup> / <sub>2</sub> "
			A4-A5, 8 <sup>1</sup> / <sub>2</sub> " × 11", 5 <sup>1</sup> / <sub>2</sub> " × 8 <sup>1</sup> / <sub>2</sub> "
3 holes type (inch version)	3 holes		A3, B4, 11" × 17"
			A4, B5, 8 <sup>1</sup> / <sub>2</sub> " × 11"
2 & 3 holes type (inch version)			

❖ **Paper weight:**

- 4 holes: 52 – 128 g/m<sup>2</sup>, 14 lb. – 34 lb. Bond
- 2 & 3 holes: 52 – 163 g/m<sup>2</sup>, 14 lb. – 43 lb. Bond

❖ **Power consumption:**

60 W (supplied from the main machine)

❖ **Dimensions (W × D × H):**

- 4 holes: 92 × 463 × 100 mm, 3.6" × 18.2" × 3.9"
- 2 & 3 holes, 2 & 4 holes: 105 × 463 × 100 mm, 4.1" × 18.2" × 3.9"

❖ **Weight:**

- 4 holes: Approx. 2.4 kg, 5.3 lb
- 2 & 3 holes, 2 & 4 holes: Approx. 2.6 kg, 5.7 lb

 **Note**

Specifications are subject to change without notice.

---

## Others

### ❖ A3/11" × 17" Tray Unit (optional)

You can load A3 or 11" × 17" paper in tray 1 using this unit.

### ❖ Output Jogger (optional)

You can tidy the printout with Finisher 3000B (100-Sheet Staples).

# Copy Paper

## Recommended Paper Sizes and Types

The following limitations apply to each tray:

	Tray	Metric version	Inch version	Paper weight	Paper capacity
Main machine	Tray 1 <sup>*1</sup> (Tandem tray)	A4 ☐, 8 1/2" × 11" ☐	A4 ☐, 8 1/2" × 11" ☐	52–163 g/m <sup>2</sup> , 16 lb. Bond– 90 lb. Index	1,000 sheets + 1,000 sheets
	Tray 1 <sup>*1</sup> (Optional A3/11" × 17" Tray Kit)	A3 ☐, B4 ☐, A4 ☐ ☐, 8 1/2" × 11" ☐ ☐, 8 1/2" × 14" ☐ ☐	A3 ☐, B4 ☐, A4 ☐ ☐, 8 1/2" × 11" ☐ ☐, 8 1/2" × 14" ☐ ☐	52–163 g/m <sup>2</sup> , 16 lb. Bond– 90 lb. Index	1,000 sheets
	Tray 2, 3 <sup>*2</sup>	A3 ☐, B4 ☐, A4 ☐ ☐, B5 ☐ ☐, A5 ☐ ☐, 11" × 17" ☐, 8 1/2" × 14" ☐, 8 1/2" × 11" ☐ ☐, 5 1/2" × 8 1/2" ☐ ☐, 7 1/4" × 10 1/2" ☐, 8 1/2" × 13" ☐, 8" × 13" ☐, 8 1/4" × 13" ☐, 11" × 15" ☐, 10" × 14" ☐, 8" × 10 1/2" ☐, 8" × 10" ☐, 12" × 18" ☐, 8K ☐, 16K ☐ ☐	A3 ☐, B4 ☐, A4 ☐ ☐, B5 ☐ ☐, A5 ☐ ☐, 11" × 17" ☐, 8 1/2" × 14" ☐, 8 1/2" × 11" ☐ ☐, 5 1/2" × 8 1/2" ☐ ☐, 7 1/4" × 10 1/2" ☐, 8 1/2" × 13" ☐, 8" × 13" ☐, 8 1/4" × 13" ☐, 11" × 15" ☐, 10" × 14" ☐, 8" × 10 1/2" ☐, 8" × 10" ☐, 12" × 18" ☐, 8K ☐, 16K ☐ ☐	52–163 g/m <sup>2</sup> , 16 lb. Bond– 90 lb. Index	500 sheets
		Custom size vertical: 139 – 305 mm horizontal: 139 – 458 mm	Custom size vertical: 5.5" – 12" horizontal: 5.5" – 18"		
LCT	Tray 4, 5 <sup>*3 *4</sup>	A4 ☐, A5 ☐ ☐, 8 1/2" × 11" ☐, 5 1/2" × 8 1/2" ☐ ☐, B5 ☐	A4 ☐, A5 ☐ ☐, 8 1/2" × 11" ☐, 5 1/2" × 8 1/2" ☐ ☐, B5 ☐	52–216 g/m <sup>2</sup> , 16 lb. Bond– 80 lb. Cover	1,000 sheets
	Tray 6 <sup>*1 *3 *4</sup>	A4 ☐, A5 ☐ ☐, 8 1/2" × 11" ☐, 5 1/2" × 8 1/2" ☐ ☐, B5 ☐	A4 ☐, A5 ☐ ☐, 8 1/2" × 11" ☐, 5 1/2" × 8 1/2" ☐ ☐, B5 ☐	52–163 g/m <sup>2</sup> , 16 lb. Bond– 90 lb. Index	2,550 sheets



	Tray	Metric version	Inch version	Paper weight	Paper capacity
Multi bypass tray (Tray 7)	Tray 7	A3☐, B4☐, A4☐ ☐, B5☐☐, A5☐☐, 11" × 17"☐, 8 <sup>1</sup> / <sub>2</sub> " × 14"☐, 8 <sup>1</sup> / <sub>2</sub> " × 11"☐ ☐, 5 <sup>1</sup> / <sub>2</sub> " × 8 <sup>1</sup> / <sub>2</sub> "☐ ☐, 7 <sup>1</sup> / <sub>4</sub> " × 10 <sup>1</sup> / <sub>2</sub> "☐, 8 <sup>1</sup> / <sub>2</sub> " × 13"☐, 8" × 13"☐, 8 <sup>1</sup> / <sub>4</sub> " × 13"☐, 11" × 15"☐, 10" × 14" ☐, 8" × 10 <sup>1</sup> / <sub>2</sub> "☐, 8" × 10"☐, 12" × 18"☐, 8K☐, 16K☐☐	A3☐, B4☐, A4☐ ☐, B5☐☐, A5☐☐, 11" × 17"☐, 8 <sup>1</sup> / <sub>2</sub> " × 14"☐, 8 <sup>1</sup> / <sub>2</sub> " × 11"☐ ☐, 5 <sup>1</sup> / <sub>2</sub> " × 8 <sup>1</sup> / <sub>2</sub> "☐ ☐, 7 <sup>1</sup> / <sub>4</sub> " × 10 <sup>1</sup> / <sub>2</sub> "☐, 8 <sup>1</sup> / <sub>2</sub> " × 13"☐, 8" × 13"☐, 8 <sup>1</sup> / <sub>4</sub> " × 13"☐, 11" × 15"☐, 10" × 14"☐, 8" × 10 <sup>1</sup> / <sub>2</sub> "☐, 8" × 10"☐, 12" × 18" ☐, 8K☐, 16K☐☐	52–216 g/m <sup>2</sup> , 16 lb. Bond– 80 lb. Cover	500 sheets
		Custom size vertical: 139 – 305 mm horizontal: 139 – 458 mm	Custom size vertical: 5.5" – 12" horizontal: 5.5" – 18"		

<sup>\*1</sup> The paper tray fence is fixed. If you want to change the size of paper set in this tray, contact your service representative.

<sup>\*2</sup> If you want to copy onto custom size paper, select the size using the Tray Paper Setting function. See p.93 “Paper Tray Settings”.

<sup>\*3</sup> If you want to copy onto OHP transparencies or thick paper, select OHP or Thick Paper mode. See p.93 “Paper Tray Settings”.

<sup>\*4</sup> When setting copy paper, make sure the stack height does not exceed the limit mark. The maximum number of sheets you can set at once depends on the paper's thickness and condition.

### Important

- Feeding damp or curled paper into the machine might cause a misfeed, staple jam, mis-stapling, a marked edge or irregular output. Try turning over the paper stack in the paper tray. If there is no improvement, change to a stiffer paper.
- When you use damp or curled adhesive labels, misfeeds might occur.
- When you set Index tabs, use the end fence for Index tabs.

### Note

- If you load paper of the same size in two or more trays, the machine automatically shifts to the other tray when the tray in use runs out of paper. This function is called Auto Tray Switching. This saves interrupting a copy run to replenish paper even when making a large number of copies. You can turn off this function. See “Auto Tray Switching” and “Selecting Copy Paper”, *Copy Reference*.
- When you use OHP transparencies, shuffle them each time.
- When you load OHP transparencies, check the front and back of the sheets, and place them correctly, or misfeeds might occur.
- When you want to copy onto translucent paper or paper lighter than 20 lbs, 80 g/m<sup>2</sup>, set the paper as shown in the following illustration. Not doing so might cause a paper jam, marked edges or the paper edges to be folded.

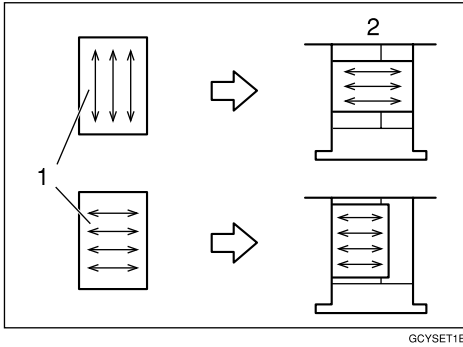

**1. Direction of paper grain**

**2. How to set the copy paper in the paper tray**

- If you want to set 20 lbs, 80g/m<sup>2</sup> or heavier paper, set the paper as shown in the following illustration.

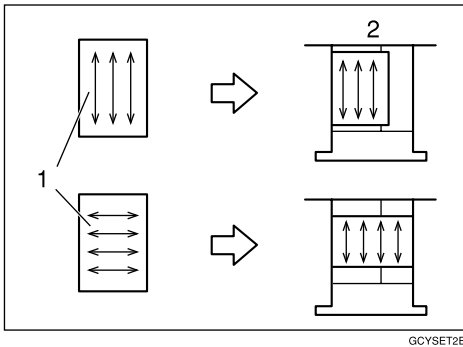

**1. Direction of paper grain**

**2. How to set the copy paper in the paper tray**

- If you load recycled or special paper in the paper trays and use the Tray Paper Settings, this function is not available with these trays unless their settings are identical.
- Feeding B5, A5, or 8<sup>1</sup>/<sub>2</sub>" × 5<sup>1</sup>/<sub>2</sub>" paper into the machine might cause a marked edge or a misfeed. In this case, change the orientation or turn over the paper stack in the paper tray.

---

## Non-recommended Paper

---

### **CAUTION:**

- *Do not use aluminum foil, carbon paper, or similar conductive paper to avoid a fire or machine failure.*

### **Important**

- Do not use any of the following kinds of paper or a fault might occur.
  - Paper for inkjet printers
  - Thermal fax paper
  - Art paper
  - Aluminum foil
  - Carbon paper
  - Conductive paper
  - Colored OHP transparencies
  - Paper with perforations
  - Envelope
  - Fancy paper

### **Note**

- Do not use the following kinds of paper or a misfeed might occur.
  - Bent, folded, or creased paper
  - Torn paper
  - Slippery paper
  - Perforated paper
  - Rough paper
  - Thin flexible paper
  - Paper coated with a lot of paper dust
- Copying onto rough grain paper can result in blurred copy image and reduced solid fill.

---

## Paper Storage

---

 **Note**

- When storing paper, the following precautions should always be followed:
  - Do not store paper where it will be exposed to direct sunlight.
  - Avoid storing paper in humid (greater than 70%) areas.
  - Store on a flat surface.
- Do not store paper vertically.
- Under extremely high or low conditions of temperature/humidity, store paper in vinyl bags.

# INDEX

## A

---

- A3/11" × 17" Tray Unit, 169
- Access to the Machine, 145
- Adding
  - Staples*, 127
- Adding Staples
  - Booklet Finisher (Saddle Stitch)*, 129
  - Finisher 3000B (100-Sheet Staples)*, 131
  - Finisher 3000M (50-Sheet Staples)*,  
*Booklet Finisher*, 127
- Address Book
  - Change Order*, 72
  - Edit Title*, 72
  - Program/Change/Delete Group*, 71
- Address Book Management, 71
- ADF Original Table Elevation, 66
- Auto Delete File, 73
- Auto Document Feeder (ADF), 17
- Auto Off, 28
- Auto Off Timer, 66
- Available Functions, 13
  - Copier Mode*, 13
  - Document Server Mode*, 14
  - Printer Mode*, 13
  - Scanner Mode*, 13

## C

---

- Changing
  - Display Language*, 148
  - E-mail Destination*, 83
  - File Name*, 40
  - Group Name*, 90
  - Modes*, 27
  - Paper Size*, 122
  - User Code*, 77
- Changing the Paper Size
  - Tray 2*, 122
  - Tray 3*, 122
- Checking
  - Job List*, 29
  - Stored Documents*, 42
- Clearing
  - Counter*, 80
  - E-mail Destination*, 84
  - User Code*, 78
- Clearing Misfeeds, 113
- Clear key, 21

- Clear Modes/Energy Saver key, 20
- Combined Function Operations, 27
- Control Panel, 20
- Control panel, 17
- Copier/Document Server Auto Reset  
Timer, 67
- Copy Count Display (Copier/Document  
Server), 62
- Copy Paper, 170
- Counter
  - Clearing*, 80
  - Displaying*, 148
- Counter for Each User Code
  - Displaying*, 79
  - Printing*, 79

## D

---

- Delete All Files, 73
- Deleting
  - E-mail Destination from a Group*, 88
  - Group*, 90
  - Job List*, 31
- Display/Clear/Print Counter per User  
Code, 70
- Displaying
  - Counter*, 148
  - Counter for Each User Code*, 79
  - E-mail Destination*, 89
- Display Language
  - Changing*, 148
- Display Panel, 21
- Display panel, 23
- Display/Print Counter, 70
- Document feeder
  - Cleaning*, 146
- Document Server, 35
  - Deleting*, 51
  - Settings*, 56
  - Using*, 37
- Document Server Mode
  - File Printing*, 15
  - On Demand Printing*, 15
  - Operation from a Computer*, 15
- Do's And Don'ts, 141
- Duplex Priority, 10

## E

---

- E-mail Destination, 81

*Changing*, 83  
    *Clearing*, 84  
    *Displaying*, 89  
    *Registering*, 81  
Energy Saver Timer, 66  
ENERGY STAR Program, 9  
Entering Text, 91  
Exiting  
    *User Tools*, 61  
Exposure glass, 17  
    *Cleaning*, 146  
External Options, 19

## F

---

File Name  
    *Changing*, 40  
Front Cover, 17  
Function Priority, 62  
Function Reset Timer, 63

## G

---

General Features, 62  
Group  
    *Deleting*, 90  
Group Name  
    *Changing*, 90

## I

---

Indicators, 21  
Inquiry, 147  
Interleave Print, 63  
Interrupt key, 20

## J

---

Jammed Staples  
    *Removing*, 133  
Job List, 29  
    *Checking*, 29  
    *Deleting*, 31  
Job List Display Time, 65

## K

---

Key Counter Management, 69  
Key Operator Code, 69  
Key Operator Tools, 69

## L

---

Large Capacity Tray (LCT), 19  
Loading Paper, 102

*Interposer*, 107  
    *Large Capacity Tray (Tray 4, Tray 5,  
        and Tray 6)*, 105  
    *Tray 1 (Tandem Tray)*, 102  
    *Tray 2*, 104  
    *Tray 3*, 104  
Low Power Mode, 28

## M

---

Machine Environment, 143  
Machine Types, 11  
Main Machine, 155  
Main Power  
    *Turning Off*, 25  
    *Turning On*, 24  
Main power switch, 17, 24  
Maintaining Your Machine, 146  
Misfeeds, 113  
Moving, 144  
Multi-Access, 32

## N

---

Number keys, 21

## O

---

Off Mode, 9  
On indicator, 17  
Operation switch, 17, 24  
Option, 19  
Output  
    *Copier*, 64  
    *Document Server*, 65  
    *Printer*, 65  
Output Jogger, 169

## P

---

Panel Off Timer, 67  
Panel Tone, 62  
Paper tray, 17  
Paper Tray Priority  
    *Copier*, 65  
    *Printer*, 65  
Password  
    *Setting or changing*, 41  
Power  
    *Turning Off*, 25  
    *Turning On*, 25  
Power Connection, 144  
Printing  
    *Counter for Each User Code*, 79

- Saved Documents*, 44
- Printing Saved Documents
  - Changing*, 46
  - Stopping*, 46
- Print Priority, 63
- Print Selected Pages, 48
- Program key, 21
- Punch Waste
  - Removing*, 138

## R

---

- Registering
  - E-mail Destination*, 81
  - E-mail Destinations to a Group*, 86, 87
  - New Group*, 86
  - User Code*, 75
- Registering or changing
  - User Name*, 39
- Remarks, 141
- Removing
  - Jammed Staples*, 133
  - Punch Waste*, 138
- Removing Jammed Staples
  - Booklet Finisher*, 133
  - Booklet Finisher (Saddle Stitch)*, 134
  - Finisher 3000B (100-Sheet Staples)*, 136

## S

---

- Safety information, 6
- Sample Copy, 46
- Sample Copy key, 21
- Saved Documents
  - Printing*, 44
  - Searching*, 43
- Saving Energy, 28
  - Auto Off*, 28
  - Low Power Mode*, 28
  - System Reset*, 28
- Scanner Auto Reset Timer, 67
- Screen Contrast Knob, 20
- Searching
  - by File Name*, 44
  - by User Name*, 43
  - Saved Documents*, 43
- Select Title, 72
- Set Date, 68
- Set Time, 68
- Setting or changing
  - Password*, 41
- Settings
  - Document Server*, 56
- Sleep Mode, 9

- Specification, 155
  - Main Machine*, 155
- Staples
  - Adding*, 127
- Start key, 21
- Stop, 21
- Stored Documents
  - Checking*, 42
- Storing Data, 37
- Suspend Copy
  - Finisher 3000B (100-Sheet Staples)*, 110
- System Auto Reset Timer, 67
- System Reset, 28

## T

---

- Text
  - Deleting*, 92
  - Entering*, 92
- Timer Setting, 66
- Toner, 142
  - Handling*, 142
  - Storing*, 142
- Toner Cover, 17
- Troubleshooting, 99
- Turning Off
  - Main Power*, 25
  - Power*, 25
- Turning On
  - Main Power*, 24
  - Power*, 25

## U

---

- User Code
  - Changing*, 77
  - Clearing*, 78
  - Registering*, 75
- User Code Management, 69
- User Codes, 75
- User Management, 16
  - Using*, 16
- User Name
  - Registering or changing*, 39
- User Tools
  - Exiting*, 61
- User Tools/Counter key, 21
- User Tools Menu (System Settings), 57
- User Tools (System Settings), 57
- Using
  - Document Server*, 37
  - User Management*, 16

## **V**

---

Ventilation hole, 18

## **W**

---

Warm Up Notice (Copier/Document Server), 62

Weekly Timer, 68

Weekly Timer Code, 68

Where to Put Your Machine, 143



---

**4090/40105**  
*9002/10512*  
*LD090/LD0105*  
**Aficio™ 2090/2105**

## Operating Instructions Copy Reference

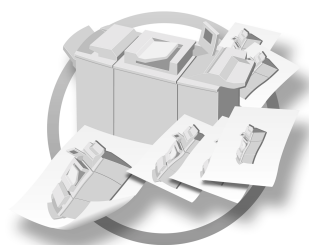

- 
- 1** Placing Originals
  - 2** Copying
  - 3** Troubleshooting
  - 4** User Tools (Copier/Document Server Features)
  - 5** Specifications

Type for 4090/9002/LD090 Aficio 2090  
Type for 40105/10512/LD0105 Aficio 2105  
Printed in Japan  
EN (USA) B071-8607

## Introduction

This manual contains detailed instructions on the operation and maintenance of this machine. To get maximum versatility from this machine all operators should carefully read and follow the instructions in this manual. Please keep this manual in a handy place near the machine.



## Notes

Some illustrations in this manual might be slightly different from the machine.  
Certain options might not be available in some countries. For details, please contact your local dealer.



## Warning:

Use of controls or adjustment or performance of procedures other than those specified in this manual might result in hazardous radiation exposure.

The model names of the machines do not appear on the following pages. Check the type of your machine before reading this manual. (For details, see p.2 "Machine Types".)

- Type 1 : 4090/9002/LD090/Aficio 2090
- Type 2 : 40105/10512/LD0105/Aficio 2105

Certain types may not be available in some countries. For details, contact your local dealer.

Two kinds of size notation are employed in this manual. With this machine refer to the inch version.

For good copy quality, the manufacturer recommends that you use manufacturer-genuine toner from the supplier.

The manufacturer shall not be responsible for any damage or expense that may result from use of parts other than manufacturer-genuine parts.

## Power Source

- 208 - 240V, 60Hz, 20A

Be sure to connect the power cord to a power source as above. For details about the power source, see "Power Connection", *General Settings Guide*.

In accordance with IEC 60417, this machine uses the following symbols for the main power switch:

**I** means **POWER ON.**

**⏻** means **STAND BY.**

# Manuals for This Machine

The following manuals describe the operational procedures of this machine. For particular functions, see the relevant parts of the manual.

## **Note**

- Manuals provided are specific to machine type.
- Adobe Acrobat Reader is necessary to view the manuals as a PDF file.
- Two CD-ROMs are provided:
  - CD-ROM 1 “Operating Instructions for Printer / Scanner”
  - CD-ROM 2 “Scanner Driver & Document Management Utilities”

## ❖ **General Settings Guide**

Provides an overview of the machine.

It also describes System Settings (such as paper trays and user codes settings), Document Server functions, and troubleshooting.

## ❖ **Network Guide (PDF file - CD-ROM1)**

Describes procedures for configuring the machine and computers in a network environment.

## ❖ **Copy Reference (this manual)**

Describes operations, functions, and troubleshooting for the machine's copier function.

## ❖ **Printer Reference 1**

Describes system settings and operations for the machine's printer function.

## ❖ **Printer Reference 2 (PDF file - CD-ROM1)**

Describes operations, functions, and troubleshooting for the machine's printer function.

## ❖ **Scanner Reference (PDF file - CD-ROM1)**

Describes operations, functions, and troubleshooting for the machine's scanner function.

### ❖ **Manuals for DeskTopBinder V2 Lite**

DeskTopBinder V2 Lite is a utility included on the CD-ROM labeled “Scanner Driver & Document Management Utilities”.

- DeskTopBinder V2 Lite Setup Guide (PDF file - CD-ROM2)  
Describes installation of, and the operating environment for DeskTopBinder V2 Lite in detail. This guide can be displayed from the **[Setup]** dialog box when DeskTopBinder V2 Lite is installed.
- DeskTopBinder V2 Lite Introduction Guide (PDF file - CD-ROM2)  
Describes operations of DeskTopBinder V2 Lite and provides an overview of its functions. This guide is added to the **[Start]** menu when DeskTopBinder V2 Lite is installed.
- Auto Document Link Guide (PDF file - CD-ROM2)  
Describes operations and functions of Auto Document Link installed with DeskTopBinder V2 Lite. This guide is added to the **[Start]** menu when DeskTopBinder V2 Lite is installed.

### ❖ **Manuals for ScanRouter V2 Lite**

ScanRouter V2 Lite is a utility included on the CD-ROM labeled “Scanner Driver & Document Management Utilities”.

- ScanRouter V2 Lite Setup Guide (PDF file - CD-ROM2)  
Describes installation of, settings, and the operating environment for ScanRouter V2 Lite in detail. This guide can be displayed from the **[Setup]** dialog box when ScanRouter V2 Lite is installed.
- ScanRouter V2 Lite Management Guide (PDF file - CD-ROM2)  
Describes delivery server management and operations, and provides an overview of ScanRouter V2 Lite functions. This guide is added to the **[Start]** menu when ScanRouter V2 Lite is installed.

### ❖ **Other manuals**

- PS3 Supplement (PDF file - CD-ROM1)
- Unix Supplement (Available from an authorized dealer, or as a PDF file on our Web site.)



# What You Can Do with This Machine

**Stamp**

Background Numbering ⇒ Page 94

Date Stamp ⇒ Page 101

Preset Stamp ⇒ Page 95

Page Numbering ⇒ Page 103

User Stamp ⇒ Page 98

Stamp Text ⇒ Page 108

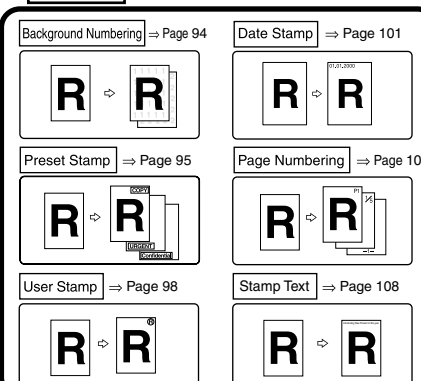

**Output**

Shift Tray Off In Sort / Stack ⇒ Page 45

Seperation ⇒ Page 45

Copy Face up ⇒ Page 109

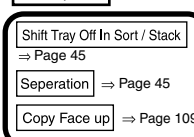

**Cover / Slip Sheet**

Front Cover ⇒ Page 86

Back Cover ⇒ Page 86

Designate ⇒ Page 88

Chapters ⇒ Page 89

Slip Sheets ⇒ Page 93

Designation Sheet Copy ⇒ Page 91

Insert Designation Sheet ⇒ Page 92

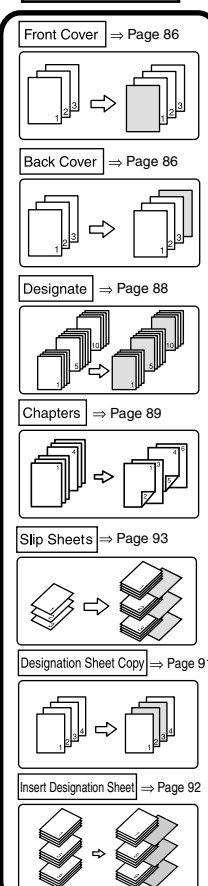

**Edit Image**

Scanning Position ⇒ Page 72

Margin Adjustment ⇒ Page 74

Border Erase / Centre / Border Erase ⇒ Page 75

Centre Erase

Border Erase

Delete Area ⇒ Page 75

3 Side Full Bleed ⇒ Page 81

Image Repeat ⇒ Page 83

Double Copies ⇒ Page 82

Centring ⇒ Page 85

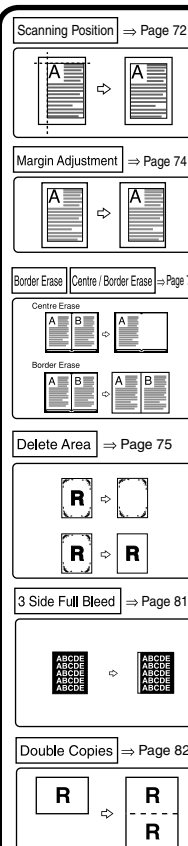

**Duplex / Combine / Series**

**Duplex**

1 Sided → 2 Sided ⇒ Page 53

2 Sided → 2 Sided ⇒ Page 53

**Combine**

1 Sided 2 Pages → Combine 1 Side ⇒ Page 56

1 Sided 4 Pages → Combine 1 Side ⇒ Page 56

1 Sided 8 Pages → Combine 1 Side ⇒ Page 56

2 Sided 1 Page → Combine 1 Side ⇒ Page 56

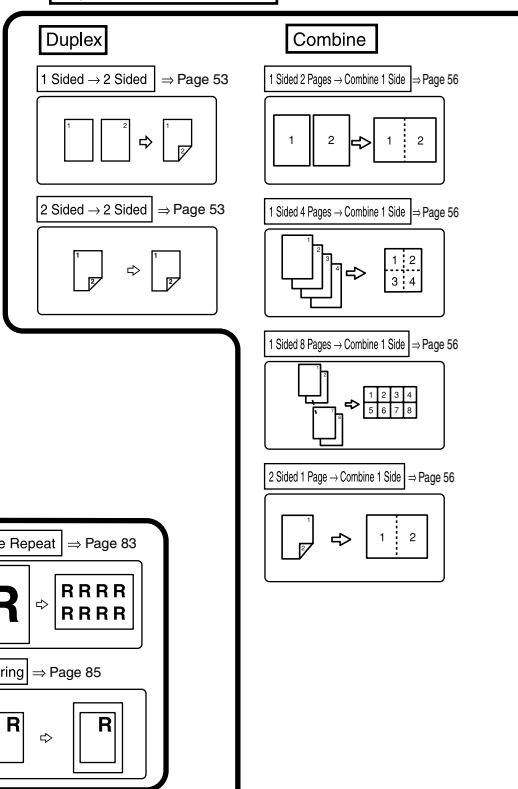



Sort

Stack

Staple

Punch

Sort ⇒ Page 42

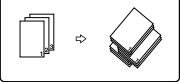

Stack ⇒ Page 46

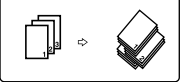

Staple ⇒ Page 46

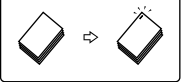

Punch ⇒ Page 50

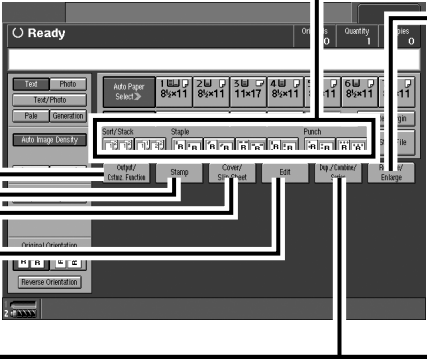
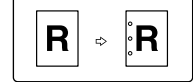

Reduce / Enlarge

Preset Reduce / Enlarge ⇒ Page 35

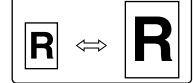

Zoom ⇒ Page 36



Size Magnification ⇒ Page 39

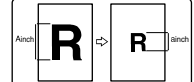

Directional Magnification(%) ⇒ Page 40



Directional Size Magnification(inch) ⇒ Page 41

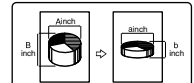

2 Sided 2 Pages → Combine 1 Side ⇒ Page 56

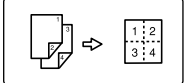

1 Sided 16 Pages → Combine 2 Side ⇒ Page 60

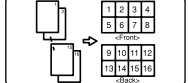

2 Sided 4 Pages → Combine 1 Side ⇒ Page 56

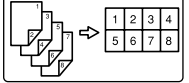

2 Sided 2 Pages → Combine 2 Side ⇒ Page 60

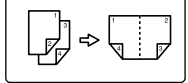

1 Sided 4 Pages → Combine 2 Side ⇒ Page 60

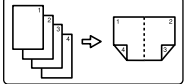

2 Sided 4 Pages → Combine 2 Side ⇒ Page 60

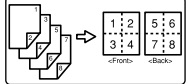

1 Sided 8 Pages → Combine 2 Side ⇒ Page 60

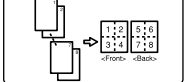

2 Sided 8 Pages → Combine 2 Side ⇒ Page 60

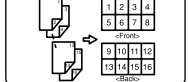

Series

2Sided → 1Sided ⇒ Page 63

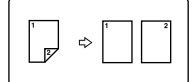

Book → 1Sided ⇒ Page 63

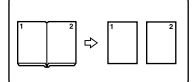

Book

Book → 2Sided ⇒ Page 65

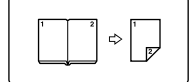

Multi → 2Sided ⇒ Page 65

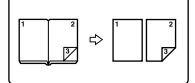

Booklet ⇒ Page 65

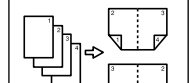

Magazine ⇒ Page 65

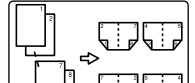

Mix 1 & 2 Sided ⇒ Page 71

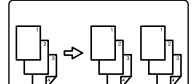

# TABLE OF CONTENTS

Manuals for This Machine .....	i
What You Can Do with This Machine .....	iv
How to Read This Manual .....	1
Machine Types .....	2
Functions that Require Options .....	3
Control Panel.....	4

## 1. Placing Originals

---

<b>Originals .....</b>	<b>7</b>
Sizes and Weights of Recommended Originals .....	7
Sizes Detectable by Auto Paper Select .....	8
Missing Image Area .....	9
<b>Placing Originals.....</b>	<b>10</b>
Original Orientation .....	10
Placing Originals on the Exposure Glass .....	13
Placing Originals in the Auto Document Feeder (ADF).....	14

## 2. Copying

---

<b>Basic Procedure.....</b>	<b>19</b>
Auto Start .....	21
Interrupt Copy .....	21
Left Original Beeper .....	22
Job Preset .....	22
Deleting a job .....	24
Copying onto Special Paper.....	25
<b>Copying from the Multi Bypass Tray (Tray 7) .....</b>	<b>27</b>
<b>Copy Functions.....</b>	<b>31</b>
Adjusting Copy Image Density .....	31
Selecting Original Type Setting.....	32
Selecting Copy Paper .....	33
Preset Reduce/Enlarge .....	35
Zoom .....	36
Auto Reduce/Enlarge .....	37
Size Magnification .....	39
Directional Magnification (%) .....	40
Directional Size Magnification (inch) .....	41
Sort.....	42
Stack .....	46
Staple .....	46
Punch .....	50
Duplex.....	53
1 Sided Combine.....	56
2 Sided Combine.....	60
Series Copies.....	63
Copying Book Originals.....	65
Mix 1 & 2 Sided .....	71

Scanning Position .....	72
Margin Adjustment .....	74
Erase .....	75
3 Edges Full Bleed .....	81
Double Copies .....	82
Image Repeat .....	83
Centering .....	85
Covers .....	86
Designate .....	88
Chapters .....	89
Designation Sheet Copy .....	91
Insert Designation Sheet .....	92
Slip Sheets .....	93
Background Numbering .....	94
Preset Stamp .....	95
User Stamp .....	98
Date Stamp .....	101
Page Numbering .....	103
Stamp Text .....	108
Copy face up .....	109
Customize function .....	109
<b>Storing Originals in the Document Server .....</b>	<b>110</b>
<b>Programs .....</b>	<b>112</b>
Storing a Program .....	112
Changing a stored program .....	113
Deleting a Program .....	114
Recalling a Program .....	114
<b>3. Troubleshooting</b>	
<hr/>	
<b>If Your Machine Does Not Operate as You Want .....</b>	<b>115</b>
When a Message is Displayed .....	115
<b>If You Cannot Make Clear Copies .....</b>	<b>116</b>
<b>If You Cannot Make Copies As You Want .....</b>	<b>117</b>
When Memory Is Full .....	119
<b>4. User Tools (Copier/Document Server Features)</b>	
<hr/>	
<b>User Tools Menu (Copier/Document Server Features) .....</b>	<b>121</b>
<b>Accessing User Tools (Copier/Document Server Features) .....</b>	<b>125</b>
Exiting User Tools .....	125
<b>Settings You Can Change with User Tools .....</b>	<b>126</b>
General Features - General .....	126
General Features - Image Adjustment .....	128
General Features - Display/Tone .....	129
Reproduction Ratio .....	131
Edit .....	131
Stamp .....	136
Input/Output .....	139

## 5. Specifications

---

Combination Chart.....	141
Supplementary Specifications.....	142
INDEX.....	154

# How to Read This Manual

---

## Symbols

---

In this manual, the following symbols are used:

### **WARNING:**

This symbol indicates a potentially hazardous situation that might result in death or serious injury if you use the machine without following the instructions under this symbol. Be sure to read the instructions, all of which are included in the Safety Information section, *General Settings Guide*.

### **CAUTION:**

This symbol indicates a potentially hazardous situation that might result in minor or moderate injury or property damage that does not involve personal injury if you use the machine without following the instructions under this symbol. Be sure to read the instructions, all of which are included in the Safety Information section, *General Settings Guide*.

- WARNINGS and CAUTIONS are notes for your safety.

### **Important**

If this instruction is not followed, paper might misfeed, originals might be damaged, or data might be lost. Be sure to read this.

### **Preparation**

This symbol indicates the information or preparation required before operating.

### **Note**

This symbol indicates precautions in operation or actions to take after mal-operation.

### **Limitation**

This symbol indicates numerical limits, functions that cannot be used together, or conditions in which a particular function cannot be used.

### **Reference**

This symbol indicates a reference.

[    ]

Keys that appear on the machine's display panel.

[    ]

Keys built into the machine's control panel.

---

## Notice

---

- The image of the display panel may differ depending on installed options.

# Machine Types

This machine comes in two models that differ by in copy speed. To determine which model you have, see the inside front cover.

	Type 1	Type 2
Copy speed	90 copies/minute (A4, 8 <sup>1</sup> / <sub>2</sub> " × 11")	105 copies/minute (A4, 8 <sup>1</sup> / <sub>2</sub> " × 11")

# Functions that Require Options

Available functions depend on the configuration of your machine and which options you have. See the table below.

○ Required options

Functions		Copying onto Tab Stock	Shift Sort	Stack	Staple	Staple (Saddle Stitch)	Punch
Options	Large Capacity Tray (LCT)	○					
	Booklet finisher		○	○	○	○	*1 ○
	Finisher 3000B (100-sheet staples)		○	○	○		*1 ○

\*1 To use the Punch function, you need the optional punch unit.

# Control Panel

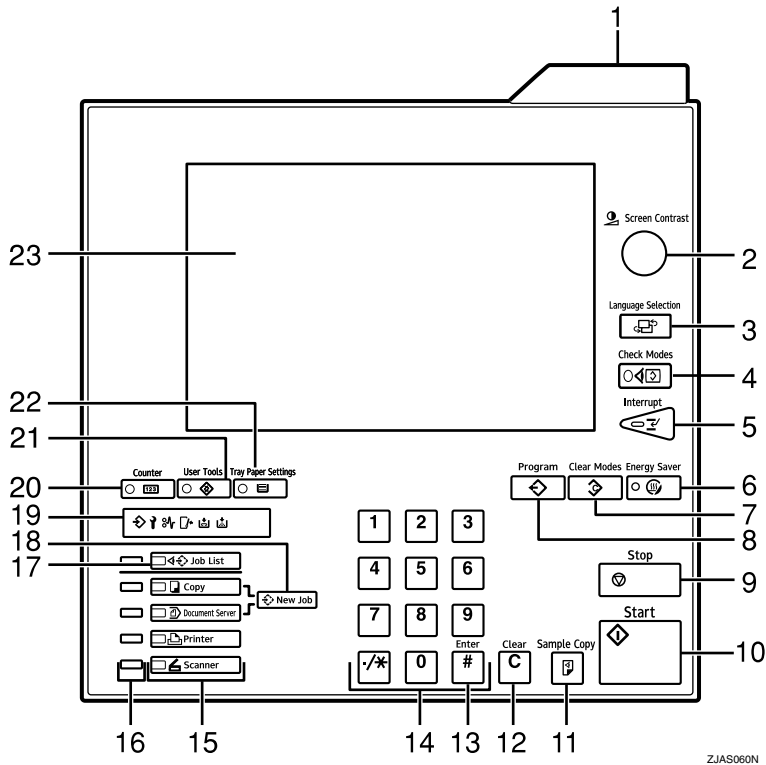

## 1. Status indicator

Machine status is described by this indicator. By default, this indicator is turned off. You can select to light the status indicator. For more information, see “Control Panel”, *General Settings Guide*.

Colour	Status
Off	Main Power Switch is turned off or ready to make copies
Flashing green	Scanning originals
Lit green	Copying (Ready to scan originals)
Flashing red	Toner has nearly run out
Lit red	Paper jam or other malfunctions

## 2. [Screen Contrast] knob

Adjusts the brightness of the display panel.

## 3. [Language Selection] key

Press to change the language of the display.

## 4. [Check Modes] key

Press to check the entered copy job settings.

## 5. [Interrupt] key

Press to make interrupt copies during a copy run. See p.21 “Interrupt Copy”.

## 6. [Energy Saver] key

Press to switch to and from Energy Saver mode.

## 7. [Clear Modes] key

Press to clear any previously entered copy job settings.



## 8. **[Program]** key

Press to register or recall a program. See p.112 “Programs”.

## 9. **[Stop]** key

Press to stop a copy job or storing data in the machine in progress.

## 10. **[Start]** key

Press to start copying or storing data in the machine.

## 11. **[Sample Copy]** key

Press to make a single sample copy set before starting a long copy run. By checking the finished set and making any necessary changes to image quality settings before you make multiple copies, you can save time and paper. See p.43 “Sample copy”.

## 12. **[Clear]** key

Press to delete a number entered.

## 13. **[#]** key

Press to enter a value or confirm a setting.

## 14. **Number keys**

Use to enter the desired number of copies and data for selected modes.

## 15. **Function keys**

Press the appropriate key to select any of the following function keys:

- Copier
- Document Server
- Printer
- Scanner

## 16. **Function status indicator**

These show the status of the functions.

- Green: the function is active.
- Red: the function has been interrupted.

## 17. **[Job List]** key

Shows the job list for a copy job or jobs stored in the Document Server.

## 18. **[New Job]** key

Use this key to set up the next copy job while a copy job or storing data in the Document Server is in progress.

## 19. **Indicators**

These indicators show the status of the machine. See “Control Panel”, *General Settings Guide*.

: Data In indicator.

: Service Call indicator

: Misfeed indicator.

: Open Cover indicator

: Add Staple indicator.

: Add Toner indicator.

## 20. **[Counter]** key

Press to check the total number of copies made.

See “Counter”, *General Settings Guide*.

## 21. **[User Tools]** key

Press to access the User Tools menu where you can customize default settings.

## 22. **[Tray Paper Settings]** key

Specify the tray to supply paper for output.

## 23. **Display panel**

Shows operation status, error messages, and function menus. See “Display Panel”, *General Settings Guide*.



# 1. Placing Originals









## Originals

---









### Sizes and Weights of Recommended Originals

---

#### ❖ Metric version

Where original is set	Original size	Original weight
Exposure glass	Up to A3	--
Auto Document Feeder (ADF)	1-sided originals: A3  - A5  	52 – 128 g/m <sup>2</sup>
	2-sided originals: A3  - A5  	52 – 105 g/m <sup>2</sup>
	Thin Paper mode: A3  - A5  	40 – 128 g/m <sup>2</sup>

#### ❖ Inch version

Where original is set	Original size	Original weight
Exposure glass	Up to 11" × 17"	--
Auto Document Feeder (ADF)	1-sided originals: 11" × 17"  - 5 1/2" × 8 1/2"  	14 – 34 lb. Bond
	2-sided originals: 11" × 17"  - 5 1/2" × 8 1/2"  	14 – 28 lb. Bond
	Thin Paper mode: 11" × 17"  - 5 1/2" × 8 1/2"  	11 – 34 lb. Bond

---

### Non-recommended originals for the Auto Document Feeder (ADF)

---

Setting the following types of originals in the ADF can cause misfeeds or damage to the originals. Place these kinds of originals on the exposure glass instead.

- Originals of inappropriate weight or size, see above
- Stapled or clipped originals
- Perforated or torn originals
- Curled, folded, or creased originals
- Pasted originals
- Coated originals, such as thermal fax paper, art paper, aluminum foil, carbon paper, or conductive paper

- Originals with perforated lines
- Originals with indexes, tags, or other projecting parts
- Sticky originals, such as translucent paper
- Thin, highly flexible originals
- Bound originals, such as books
- Transparent or translucent originals, such as OHP transparencies or tracing paper

 **Note**















If you place such originals as becoming faded by rubbing, the originals may become dirty.

---





















## Sizes Detectable by Auto Paper Select

---

◆ **Metric version**

Size	A3 	B4 	A4  	B5  	A5 	A5 	11" × 17" 	8 <sup>1</sup> / <sub>2</sub> " × 13"  *2	8 <sup>1</sup> / <sub>2</sub> " × 11"  	8K  *1	16K   *1
Where Original Is Set											
Exposure glass	○	○	○	○	×	○	×	○	×	×	×
ADF	○	○	○	○	○	○	○	○	○	○	○

◆ **Inch version**

Size	A4  	11" × 17"  	11" × 15"  	10" × 14"  	8 <sup>1</sup> / <sub>2</sub> " × 14"  	8 <sup>1</sup> / <sub>2</sub> " × 13"   *2	8 <sup>1</sup> / <sub>2</sub> " × 11"  	8" × 10"  	5 <sup>1</sup> / <sub>2</sub> " × 8 <sup>1</sup> / <sub>2</sub> "  	5 <sup>1</sup> / <sub>2</sub> " × 8 <sup>1</sup> / <sub>2</sub> "  
Where Original Is Set										
Exposure Glass	×	○	×	×	○	×	○	×	○	×
ADF	○	○	○	○	○	○	○	○	○	○

\*1 8K = 390 mm × 267 mm

16K = 267 mm × 195 mm

\*2 You can select from 8<sup>1</sup>/<sub>2</sub>" × 13", 8<sup>1</sup>/<sub>4</sub>" × 13", and 8" × 13" with the User Tools (System Settings). See "Original: <F/F4> Size Setting", *General Settings Guide*.

## ❖ Exposure glass

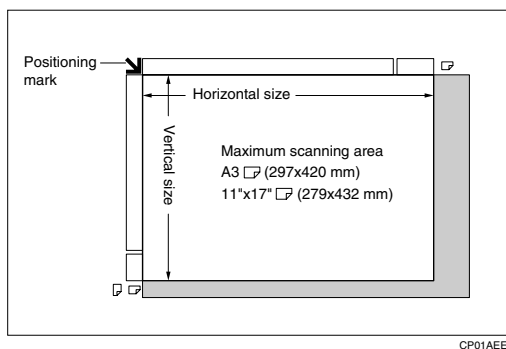

## ❖ ADF

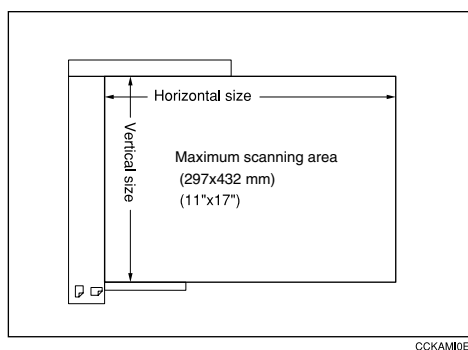

## Sizes difficult to detect

It is difficult for the machine to automatically detect the sizes of the following types of originals, so select the paper size manually instead.

- Originals with indexes, tags, or other projecting parts
- Transparent or translucent originals, such as OHP transparencies or tracing paper
- Dark originals, with many letters and drawings
- Originals that partially consist of solid images
- Originals that have solid images running to their edges
- Originals other than those marked ○ in the table p.8 "Sizes Detectable by Auto Paper Select".

## Missing Image Area

Even if you correctly place originals in the ADF or on the exposure glass, 5 mm (0.2") margins on all four sides might not be reproduced.

# Placing Originals

1

**Note**

- ❑ Place originals only after any correction fluid or ink have completely dried. Not taking this precaution may result in a dirtied exposure glass and blemished copies.

**Reference**

For document sizes you can set, see p.7 “Originals”.

---

## Original Orientation

---

When you place the original into the ADF, lay it face up so you can see the print. When you place the original on the exposure glass, lay it face down.

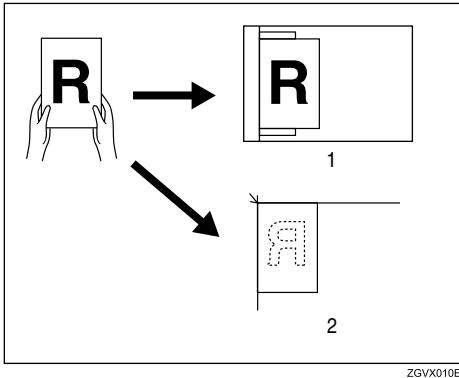

**1. ADF**

**2. Exposure glass**





You can place the original orientation in the following ways.

❖ **Standard Orientation** 

Select this when the original orientation is the same as the copy paper orientation.

## ❖ 90° Turn

This function rotates the copy image by 90°. If you cannot place originals as described because the size is A3 or A4, or because of specific circumstances, you cannot staple copies. In such cases, select .

Example: When you want to staple copies, but you cannot select  because the original size is A3  (11" × 17" ) , selecting  enables you to staple copies correctly.

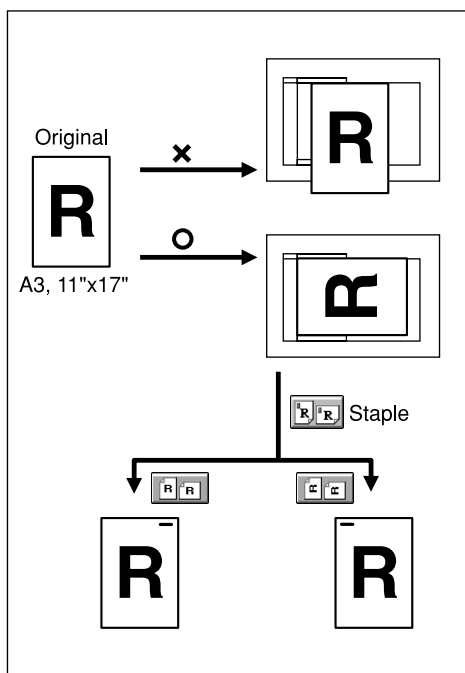



### Note

- It is recommended you use this function together with the Auto Paper Select or Preset Reduce/Enlarge function.

### **1** Select the original orientation ( or ).



## Reverse orientation

This function rotates the copy image by 180° ( or ).

This is useful for copying torn originals. For example, if the left side of the original is damaged and is difficult to set, position it as shown below.

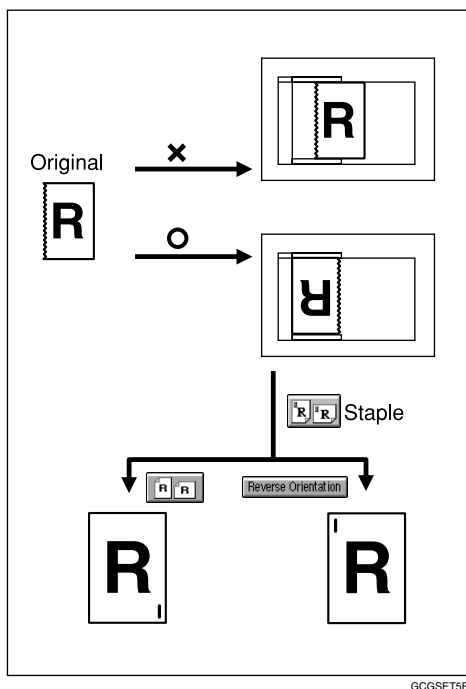

GCGSET5E

**1** Press [Reverse Orientation].

### Note

- It is recommended you use this function together with the Auto Paper Select or Preset Reduce/Enlarge function.
- Copy results may differ depending on the combination of selected functions.



## Placing Originals on the Exposure Glass

### Reference

When you place originals on the exposure glass, you can specify the way copies are delivered. See p.139 “Eject Copy Face Up/Down in Glass”.

### **1** Lift the exposure glass cover or ADF.

#### Important

Do not lift the exposure glass cover or ADF forcefully. Otherwise, ADF cover might open or be damaged.

#### Note

Be sure to lift the exposure glass cover or ADF to an angle of more than 30°. Otherwise, the size of the original might not be correctly detected.

### **2** Place the original face down on the exposure glass. The original should be aligned against the rear left corner.

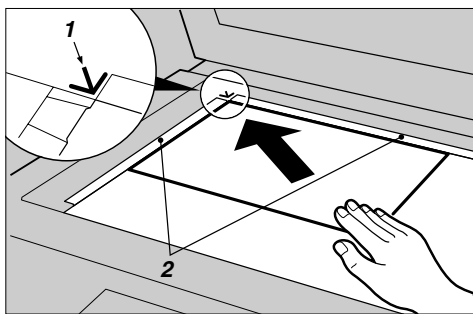

ND1001EE

#### 1. Positioning mark

#### 2. Left scale

#### Note

Start with the first page to be copied.

### **3** Lower the ADF.

## Placing Originals in the Auto Document Feeder (ADF)

Settings should be made in the following situations:

1

- ❖ **When placing originals of more than 100 pages:**  
See p.15 “Batch mode”.
- ❖ **When placing originals one by one:**  
See p.16 “SADF mode”.
- ❖ **When copying originals of various sizes:**  
See p.16 “Mixed size mode”.
- ❖ **When copying originals onto thin paper**  
See p.17 “Thin mode”.
- ❖ **When placing custom size originals:**  
See p.18 “Placing custom size originals”.

### Important

- If you turn on the machine with an original left on the exposure glass and started copying while placing originals in the ADF, a paper jam will occur. Before turning the machine on, check there is no original left on the exposure glass.

### Note

- Do not stack originals over the limit mark on the inner side wall of the ADF.
- The last page should be on the bottom.
- To copy thin originals of 40 to 52 g/m<sup>2</sup> (35 to 45 kg), two or more originals may be fed at a time, and be damaged. To avoid this, place originals one by one in the ADF, or place an original on the exposure glass.

- 1** Set the document guide to the original size.
- 2** Align the edges of the original and place it in the ADF with the side to be copied facing up.

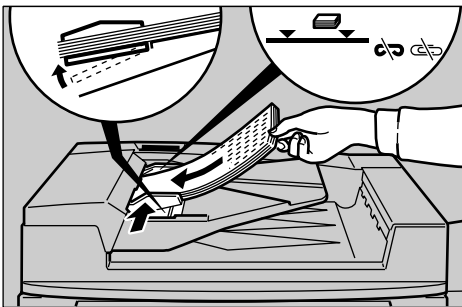

1. Limit mark
2. Document guide

**Note**

- Once the bottom plate of the ADF rises, do not place or insert originals in the ADF.
- Straighten curls in the original before placing it in the ADF.
- To prevent multiple sheets being fed at once, fan stacks of originals before placing them in the ADF.
- Place the original squarely.
- You can set the rise time of the bottom plate of the ADF. See “ADF Original Table Elevation”, *General Settings Guide*.

**Batch mode**

In batch mode, the machine copies originals of more than 100 pages as a single document, even if it is placed in the ADF in sections.

**Important**

- Place special originals, such as translucent paper, individually.

**1** Press **[Special Original]**.

**Note**

- You can also set to display **[Batch]** in initial settings. See p.129 “Special Original Display”.

**2** Press **[Batch]**, and then **[OK]**.



**3** Place the first section of the original, and then press the **[Start]** key.

**4** After the first section of the original has been fed, place the next, and then press the **[Start]** key.

**5** If Sort, Combine, or 1 Sided→2 Sided function is used, press the **[#]** key after all of the originals have been fed.

**Note**

- If you want to copy subsequent originals in this mode, repeat step **4**.

---

## SADF mode

---

In SADF mode, each page is automatically fed when placed, even when an original is placed page by page.

### 1 Press [Special Original].

#### Note

- You can also set to display [SADF] in initial settings. See p.129 “Special Original Display”.

### 2 Press [SADF], and then [OK].

### 3 Place one page of the original, and then press the [Start] key.

The Auto Feed indicator appears on the display.

### 4 After all of the originals have been fed, make sure the Auto Feed indicator is lit, and then place the next page of originals.

The second and subsequent pages of originals will be fed automatically without pressing the [Start] key.

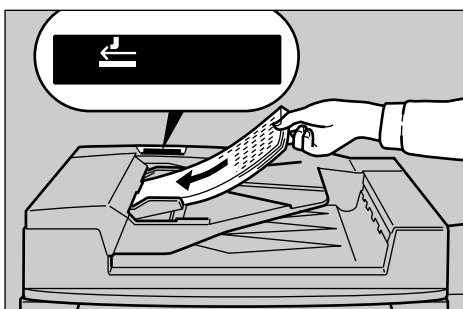

#### Reference

You can set the period to make the Auto Feed indicator keep lit after an original is fed, to indicate that it is ready for another original. See p.139 “SADF Auto Reset”.

---

## Mixed size mode

---

When you place different size originals in the ADF at the same time, the machine automatically checks their sizes and makes copies.

#### Note

- When placing originals of different sizes in the ADF and making copies without using the Mixed Size mode, parts of the original image might not be copied or paper jams may occur.

- The sizes of originals that can be placed together with this function are as follows:

Metric version	A3☐, B4☐, A4☐☐, B5☐☐, A5☐☐, 11"×17"☐, 8 <sup>1</sup> / <sub>2</sub> "×13"☐, 8 <sup>1</sup> / <sub>2</sub> "×11"☐, 8 K☐, 16 K ☐☐
Inch version	A4☐☐, 11"×17"☐, 8 <sup>1</sup> / <sub>2</sub> "×14"☐, 8 <sup>1</sup> / <sub>2</sub> "×11"☐☐, 5 <sup>1</sup> / <sub>2</sub> "×8 <sup>1</sup> / <sub>2</sub> "☐☐, 8"×10"☐, 11"×15"☐, 10"×14"☐, 8 <sup>1</sup> / <sub>2</sub> "×13"

- 1** Press **[Special Original]**.

 **Note**

- You can also set to display **[Mixed Size]** in initial settings. See p.129 "Special Original Display".

- 2** Press **[Mixed Sizes]** and then **[OK]**.

- 3** Align the rear and left edges of originals as shown in the illustration.

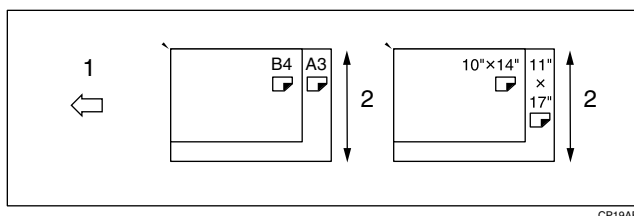

- 1.** Place into the ADF.

- 2.** Vertical size

- 4** Adjust the guide to the widest original size.

- 5** Place aligned originals face up into the ADF.

- 6** Press the **[Start]** key.

---

### Thin mode

---

Use Thin mode for copying thin originals using the ADF.

- 1** Press **[Special Original]**.

 **Note**

- You can also set to display **[Thin Paper]** in initial settings. See p.129 "Special Original Display".

- 2** Press **[Thin Paper]**, and then **[OK]**.

- 3** Place originals face up into the ADF.

- 4** Press the **[Start]** key.

## Placing custom size originals

When placing custom size originals in the ADF, specify the size of the originals.

**Note**

- ❑ Paper with a vertical length of 128–297 mm (5.1" – 11.6") and a horizontal length of 128–432 mm (5.1" – 17.0") can be placed with this function.

**1** Press **[Special Original]**.

**Note**

- ❑ You can also set to display **[Custm Size]** in initial settings. See p.129 “Special Original Display”.

**2** Press **[Custm Size]**, and then **[OK]**.

**3** Enter the horizontal size of the original using the number keys, and then press the **[#]** key.



**Note**

- ❑ If you make a mistake, press **[Clear]**, and then enter the value again.

**4** Enter the vertical size of the original using the number keys, and then press the **[#]** key.

**Note**

- ❑ To store the specified size, press **[Program]**, and then **[Exit]** in the confirmation dialog box.

**5** Press **[OK]**.

**6** Place originals, and then press the **[Start]** key.

**Note**

- ❑ You can also select the Special Original function by pressing **[Output/Cstmz. Function]**.

# 2. Copying

## Basic Procedure

- 1** When the machine is set for user codes, enter a user code using the number keys, and then press the **[#]** key.

### Reference

For Users Codes, see “User Codes”, *General Settings Guide*.

- 2** Make sure the machine is in Copy mode.

Press the copy function key.

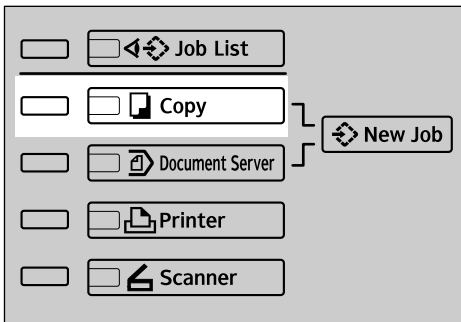

ZJAS342N

### ❖ Initial copy display

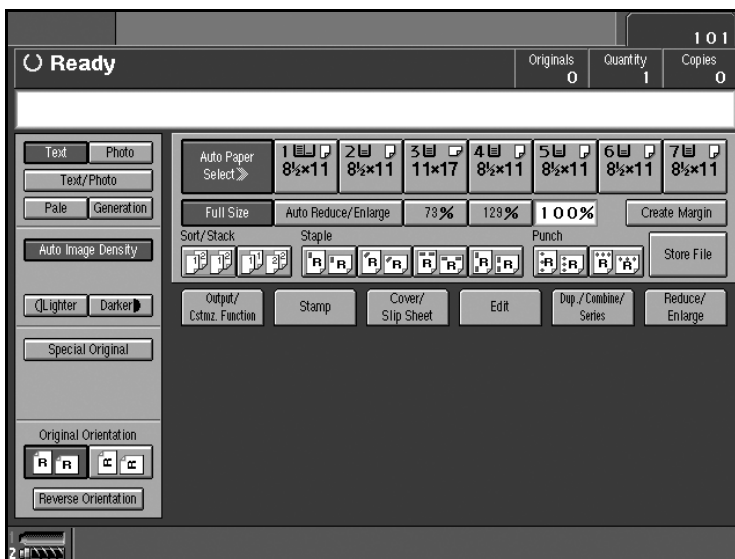

**3** Make sure no previous settings remain. **Note**

- To clear previous settings, press the **[Clear Modes]** key.

**4** Place originals. **Reference**

See p.10 "Placing Originals".

**5** Make the desired settings.**6** Enter the required number of copies using the number keys. **Note**

- The maximum copy quantity can be set between 1 and 9999 (default: 9999). See p.126 "Max. Number of Sets".

**7** Press the **[Start]** key.

The machine starts copying.

 **Note**

- When placing an original on the exposure glass or in the ADF using batch or SADF mode, press the **[#]** key after all have been scanned.

 **Reference**

You can select to have copies delivered either face up or face down. See p.139 "Eject Copy Face Up/Down in Glass" in "Input Output".

 **How to Operate****❖ To stop the machine during a multi-copy run.**

Press the **[Stop]** key.

**❖ To return the machine to the default condition after copying.**

Press the **[Clear Modes]** key.

**❖ When clearing entered values.**

Press the **[Clear]** key, or **[Clear]** on the display.

**❖ To confirm settings.**

Press the **[Check Modes]** key.



---

## Auto Start

---

If you press the **[Start]** key during the warm-up period, the **[Start]** key will blink and your copies will be made as soon as warm-up finishes.

- 1** Make any adjustments to copy settings during the warm-up period.
- 2** Place originals.
- 3** Press the **[Start]** key.

Copying Starts automatically when the **[Start]** key indicator flashes red and green indicating copy-readiness.

---

## Interrupt Copy

---

Use this function to interrupt a long copy job to make urgently needed copies.

 **Note**

- The procedure for making interrupt copies depends on the kind of operation the machine is currently carrying out.
- You can use Document Server mode during Interrupt Copy.
- The previous copy job settings will be restored and the machine will continue copying from where it left off.

- 1** Press the **[Interrupt]** key.

---

### When the machine stops scanning

---

- 1** Remove copied originals and place originals you want to copy.
- 2** Press the **[Start]** key.  
The machine starts making copies.
- 3** When the copy job is finished, remove originals and copies.
- 4** Press the **[Interrupt]** key again.  
The Interrupt indicator goes out.
- 5** When the display prompts you, place the remaining originals again before interrupting.
- 6** Press the **[Start]** key.

---

### When the machine continues copying

---

- 1** Place the originals you want to copy.
- 2** Press the **[Start]** key.  
The machine stops the other job and starts copying the new original.

③ When copying is complete, remove originals and copies.

④ Press the **[Interrupt]** key again.

The Interrupt indicator goes out.

---

## Left Original Beeper

---

The error message appears if you leave originals on the exposure glass after copying.

---

## Job Preset

---

You can set up next copy content during copy.

If a long copy job is in progress and you do not want to wait for it to finish, you can use this function to set up the next copy job in advance. When the current copy job is finished, the next job will start automatically. You can set up to 10 copy jobs.

### Note

- If the status indicator of the control panel is blinking in red, paper jam is occurring in the current copy job. Display the current job screen.

### Reference

You can set the length of interval between the end of a job and the start of a new job with the User Tools. For setting the time interval, see “Time Interval between Printing Jobs”, *General Settings Guide*.

You can select the display when you press the **[New Job]** key or **[New Job]**. See p.126 “Reverse Job Mode”.

① Press the **[New Job]** key or **[New Job]** when “Copying” appears.

② Set up the next copy job.

③ Place the originals in the ADF, and then press the **[Start]** key.

All originals are scanned.

After the current copy job, the next job starts automatically.

### Note

- Each copy job set up is stored with a job number in the preserved job screen.

## Job Preset display

The preset jobs appear as shown below.

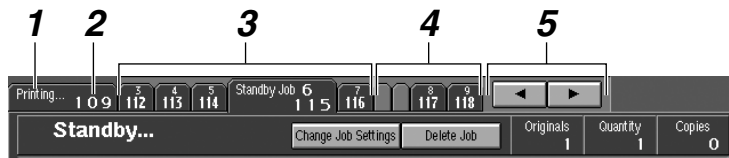

1. Job being printed
2. Job number
3. Waiting Job
4. Job set up with other functions
5. Scroll keys

### Note

- When more than ten jobs are set up including jobs for other functions.

## Editing job preset

You can check and change the contents of preset jobs. You also can delete preset jobs.

- 1 Select the job number you want to check or change.

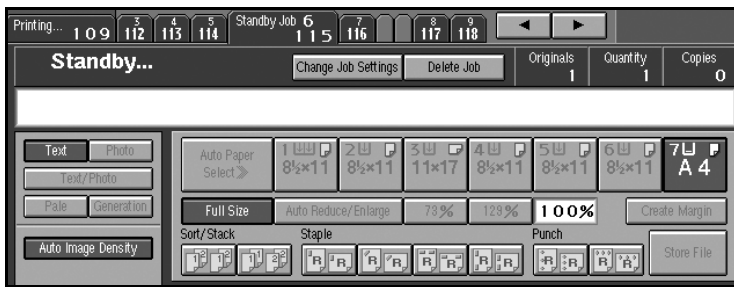

- 2 Press [Change Job Settings].

To check job contents

- 1 Check contents.

- 2 Press [OK].

The copy screen returns.

### To change job contents after checking

---

- 1** Check job contents.
- 2** Change contents, and then press [OK].
- 3** Press [Yes] in the confirmation dialog box.

You return to the copy screen.

---

### To delete a job after checking its contents

---

- 1** Check job contents.
- 2** Press [Delete Job].  
A confirmation message appears.

 **Note**

- To interrupt copying, press [Stop Printing] at the right bottom of the display, and then proceed to step **3**.

- 3** Press [Yes].  
You return to the copy screen.
- 

## Deleting a job

---

- 1** Select the number of you want to delete.
- 2** Press [Delete Job].
- 3** Press [Yes] in the confirmation dialog box.  
You return to the copy screen.

## Copying onto Special Paper

### Copying onto OHP transparencies

To make copies onto OHP transparencies, you need to specify the paper type. For details, see "Paper Tray Settings", *General Settings Guide*.

**1** Select the paper tray in which the OHP transparencies are loaded.

 **Note**

- You can not set the OHP transparencies into the optional A3/11" × 17" tray unit if it is installed in Tray 1.

**2** Place originals, and then press the **[Start]** key.

 **Important**

- When copying onto OHP transparencies, remove copied sheets one by one.

### Copying onto tab stock

You can copy onto tab stock.

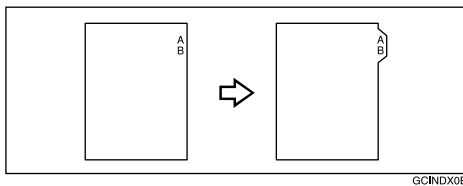

 **Preparation**

Before using this function, set the tray for tab stock and set the position of the index tab. See "Paper Type", *General Settings Guide*.

You can set the tab stock in the LCT (Trays 4-5) and multi bypass tray (Tray 7).

Check the position of the index tab to avoid the image being sheared. See "Paper Tray Settings", *General Settings Guide*.

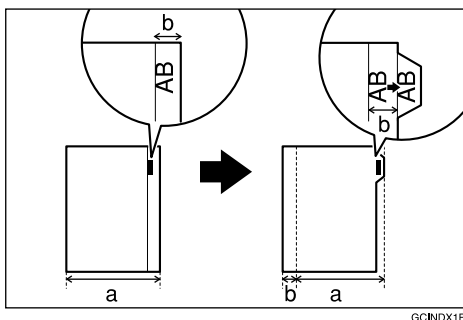

**Important**

- Set the tab stock in the tray placing the tab side outwards.
- When you set tab stock in the tray, always use the end fence.

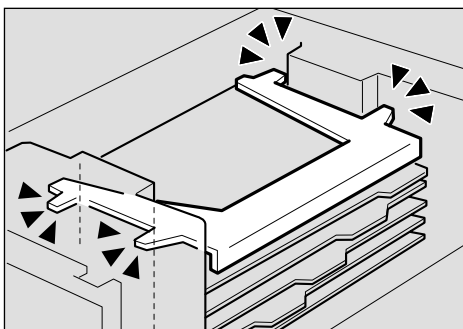

ZAJYS30E

- Tab stocks are always brought from top.

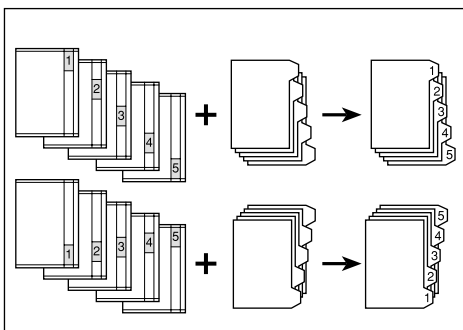

GCINDX2E

- When a paper jam has occurred, check the order of originals and tab stock, and then restart copying.

**1** Select the paper tray where the tab stock is set.

**2** Place originals, and then press the **[Start]** key.

# Copying from the Multi Bypass Tray (Tray 7)



















The multi bypass tray (Tray 7) can be used the same way as other trays. Also, thick paper of larger than A4 ( $8\frac{1}{2}'' \times 11''$ ) size is available.

## Note

- You cannot use the label paper in the multi bypass tray (Tray 7).
- The sizes of paper you can use with the multi bypass tray (Tray 7) are as follows.

Metric version	<ul style="list-style-type: none"> <li>• Vertical: 139 – 305 mm</li> <li>• Horizontal: 139 – 458 mm</li> </ul>
Inch version	<ul style="list-style-type: none"> <li>• Vertical: 5.5" – 12.0"</li> <li>• Horizontal: 5.5" – 18"</li> </ul>

- The machine can automatically detect the following sizes as standard size copy paper.

Metric version	A3  , B4  , A4  , B5  , A5  , $11'' \times 17''$  , $11'' \times 8\frac{1}{2}''$  , $5\frac{1}{2}'' \times 8\frac{1}{2}''$  , $8'' \times 13''$ 
Inch version	A3  , B4  , A4  , B5  , A5  , $11'' \times 17''$  , $8\frac{1}{2}'' \times 11''$  , $5\frac{1}{2}'' \times 8\frac{1}{2}''$  , $8'' \times 13''$ 

- The maximum number of sheets you can load into the bypass tray depends on paper type. The number should not exceed the upper limit.
- If you want to use a size of paper other than those in the above table, be sure to specify the size. See p.29 "When copying onto regular size paper".

## **1** Set the side fences (①) to the paper size.

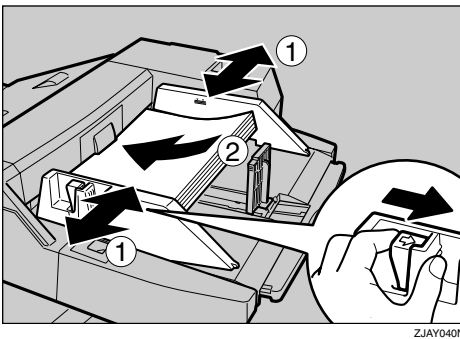

## **2** Place paper in the multi bypass tray (Tray 7).

**3** Fit the side fence to the paper, and then set the end fence (②).

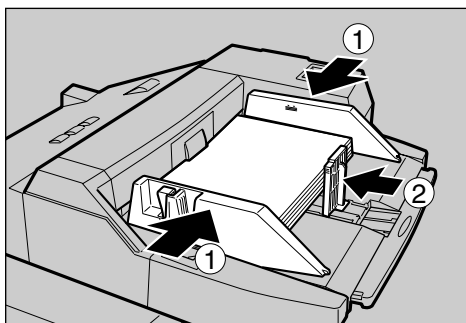

ZJAY050N

**Note**

- To remove the end fence, slide it to the left.

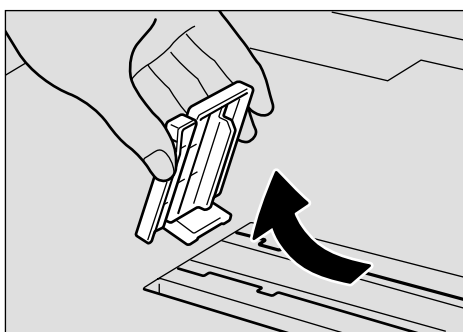

ZJIUH070J

**4** Press the elevator switch on the multi bypass tray (Tray 7).

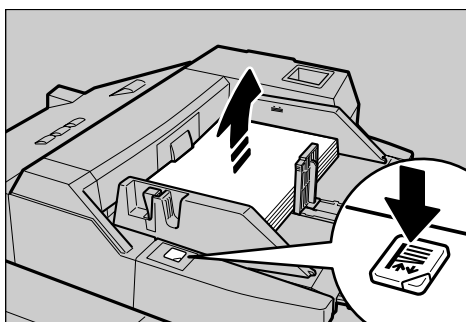

ZJAY060N

**Note**

- The green lamp of the elevator switch is blinking while the tray is going up and down, and keeps lit when it stops.
- Press the elevator switch to move down original table if you want to either add paper or remove jammed ones.



## 5 Select Tray 7 on the control panel.

### Setting the tab stock in multi bypass tray (Tray 7)

#### 1 Set the side fences to the paper size.

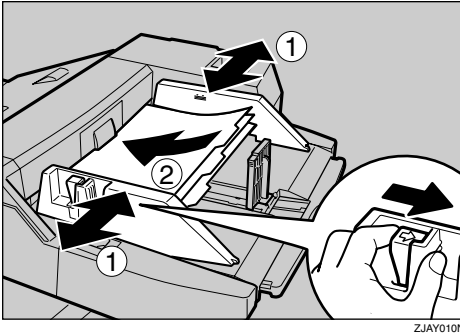

#### 2 Set the tab stock in the multi bypass tray (Tray 7), and fit the side fences to the tab stock.

#### 3 Attach the back fence to the end fence, and then set the end fence.

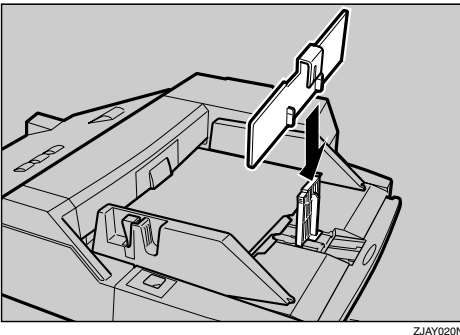

#### 4 Select [Tab Stock] in special paper settings.

##### Reference

p.30 "When copying onto special paper"

### When copying onto regular size paper

- 1 Press the [#] key.
- 2 Press [Select Regular Size].
- 3 Select the paper size.
- 4 Press [OK].

### When copying onto custom size paper

- 1 Press the [#] key.
- 2 Press [Program Custom Size].

- ③ Enter the vertical size of the paper using the number keys, and then press [#] or the [ # ] key.
- ④ Enter the horizontal size of the paper using the number keys, and then press [#] or the [ # ] key.

 **Note**

- To register the custom size entered, press [Program], and then press [Exit].

2

---

### When copying onto special paper

---

- ① Press the [ # ] key.
- ② Select paper type in “Special paper”.
  -  **Note**
  - When you select [Tab Stock], press [-] or [+] to set the amount of shifting the tab stock.
- ③ Press [OK].
- ⑥ Place originals, and then press the [Start] key.
- ⑦ When the copy job is finished, press the [Clear Modes] key to clear the settings.

---

# Copy Functions

---

---

## Adjusting Copy Image Density

---

Three types of adjustment are available:

❖ **Auto image density**

The machine automatically adjusts image density.

❖ **Manual image density**

You can adjust the density of the original in nine increments.

❖ **Combined auto and manual image density**

Use when copying originals with dirty backgrounds (such as newspaper print). You can adjust foreground density while leaving the background unchanged.

---

### Auto image density

---

**1** Make sure [Auto Image Density] is selected.

---

### Manual image density

---

**1** Press [Auto Image Density] to cancel it.

**2** Press [Lighter] or [Darker] to adjust image density.

---

### Combined auto and manual image density

---

**1** Make sure [Auto Image Density] is selected.

**2** Press [Lighter] or [Darker] to adjust the density.

## Selecting Original Type Setting

Select one of the following six types to match originals:

### ❖ Text

Select this mode when originals contain only text (no pictures).

### ❖ Photo

Delicate tones in photographs and pictures can be reproduced with this mode.

### ❖ Text/Photo

Select Text/Photo when originals contain photographs or pictures with text.

### ❖ Pale

Select this mode for originals that have light lines written in pencil, or for faintly copied slips. Faint lines will be clearly copied.

### ❖ Generation

If originals are copies (generation copies), copy image can be reproduced sharply and clearly.

### ❖ Dark Background

When you copy originals with dark background such as color tab stock (orange, green, or blue), you can remove the background color in three levels.

#### Note

- [Dark Background]** appears only when you set Dark Background to **[On]** and Original Type Display to **[Hide]** with the User Tools. See p.128 “Dark Background” and p.129 “Original Type Display”.
- If you select this mode, the auto image density function is disabled, but **[Lighter]** or **[Darker]** is enabled.

#### Reference

You can hide the original type display. See p.126 “Original Type Priority”.

You can set the picture quality for each original type. See p.128 “General Features - Image Adjustment”.

### **1** Press the appropriate key to select the original type.

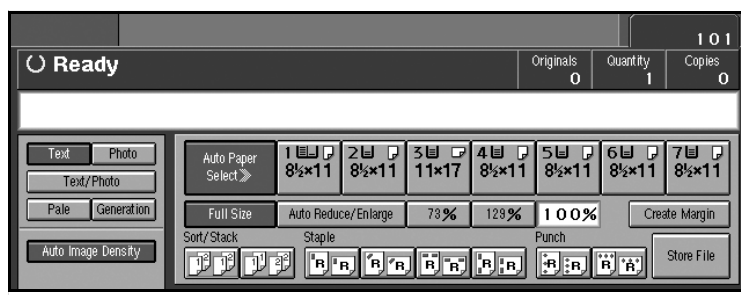

---

## When the original type keys are not displayed

---

- 1 Press [Original Type].
- 2 Select the type, and then press [OK].

---

## When the dark background is selected

---

- 1 Select the density of the background in three levels.

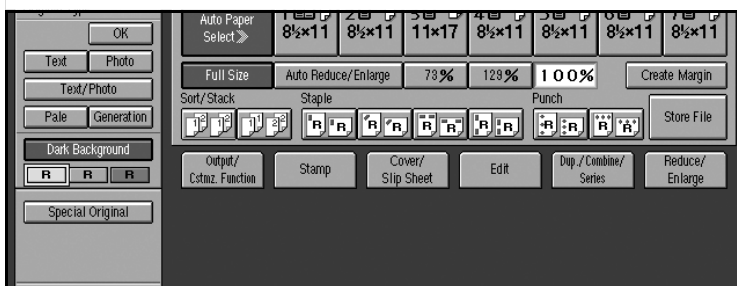

- 2 Press [OK].

---

## Selecting Copy Paper

---

There are two ways to select copy paper:

### ❖ Auto Paper Select

The machine automatically selects a suitable size of copy paper, based on original size and reproduction ratio.

#### 🔍 Reference

For Auto Paper Selection, see p.8 “Sizes Detectable by Auto Paper Select”.

### ❖ Manual Paper Select

Choose the tray containing the paper you want to copy onto, bypass tray or the LCT.

#### 🔍 Reference

For manual paper selection, see p.9 “Sizes difficult to detect”.

You can hide the paper type display.

Only the paper trays set to **[Off]** or **[Recycled Paper]** in “Paper Type” and also set to **[On]** in “Apply Auto Paper Select” can be selected in Auto Paper Select mode. See “Paper Tray Settings”, *General Settings Guide*.

---

## Auto Paper Select

---

**1** Make sure that **[Auto Paper Select]** is selected.

 **Note**

- Trays with a key mark  will not be automatically selected. See “Paper Tray Settings”, *General Settings Guide*.

---

## Manual Paper Select

---

**1** Select the paper tray, multi bypass tray (Tray 7), or LCT.

The indicator corresponding to the selected paper tray is highlighted.

---



### When the paper type keys are not displayed

---

**1** Press **[Auto Paper Select]**.

**2** Select the paper type.

 **Rotated copy**

If the orientation in which an original is placed ( or ) is different from that of the paper you are copying onto, this function rotates the original image by 90° and fits it on the copy paper. This function works when Auto Paper Select or Auto Reduce/Enlarge is selected. See p.33 “Auto Paper Select”.

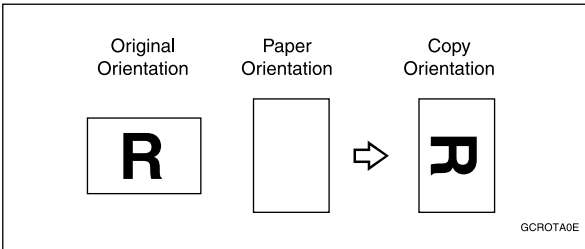

 **Note**

- This function is enabled when **[Auto Paper Select]** or **[Auto Reduce/Enlarge]** is selected. See p.33 “Selecting Copy Paper” and p.37 “Auto Reduce/Enlarge”.
- The default for “Auto Tray Switching” is “With image rotation”. You cannot use the Rotated Copy function if this setting is changed to “Without image rotation” or **[Off]**. See p.127 “Auto Tray Switching”.
- Depending on the settings for the Staple or Punch function, you cannot use Rotated Copy. See p.46 “Staple”, or p.50 “Punch”.

## Preset Reduce/Enlarge

You can select a preset ratio for copying.

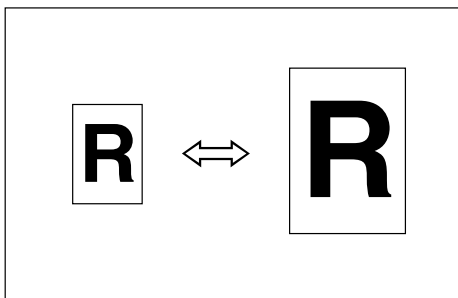

2

### Reference

You can display two types of enlarge/reduce ratio. See p.131 “Shortcut R/E”.

You can change the displayed ratio from the default to the frequently used one. See p.131 “Preset Reduce/Enlarge”.

You can change the priority of Reduce/Enlarge ratio. See p.131 “Preset Reduce/Enlarge Priority”.

### 1 Press [Reduce/Enlarge].

#### Note

- To select a preset ratio on the initial display, press the shortcut reduce/enlarge key, and then proceed to step 4.

### 2 Check that [Preset R/E] is selected.

### 3 Select a ratio.

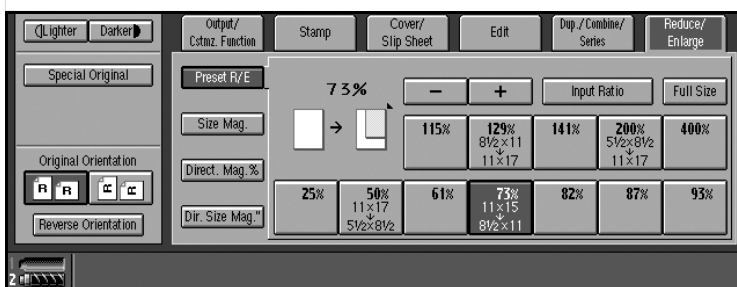

### 4 Place originals, and then press the [Start] key.

## 💡 Create Margin Mode

Use “Create Margin” to reduce the image to 93% of its original size and to place the reduced image at the center. By combining it with the Reduce/Enlarge function, you can also provide the Reduce/Enlarge copy with a margin.

## 🔍 Reference

For setting margins, see p.131 “Create Margin Ratio”.

- 1 Press **[Create Margin]**.

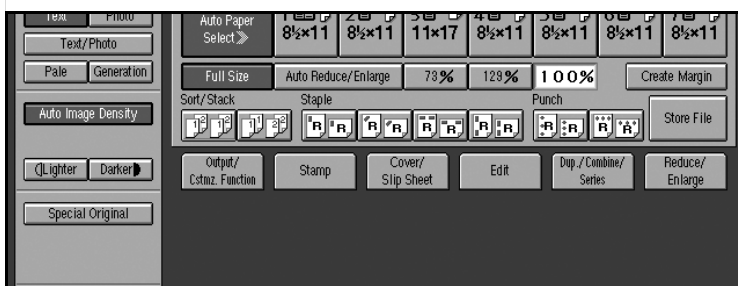

- 2 If you do not want to combine it with the Reduce/Enlarge function, place originals, and then press the **[Start]** key.

## Zoom

You can change the reproduction ratio (25% to 400%) in increments of 1%.

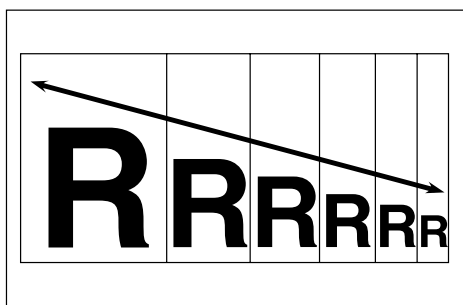

## 📌 Note

- ❑ You can select a preset ratio nearest the desired ratio, then adjust the ratio with **[+]** or **[-]**.

- 1 Press **[Reduce/Enlarge]**.



## 2 Enter the ratio.

To select a ratio with [**+**] and [**-**]

- 1 Select a preset ratio that is closest to the desired ratio.
- 2 Adjust the ratios with [**+**] or [**-**].

### Note

- To change the ratio in 1% increments, just press [**+**] or [**-**]. To change the ratio in 10% increments, press and hold down [**+**] or [**-**].
- If you have entered a ratio incorrectly, readjust using [**+**] or [**-**].

To enter a ratio using the number keys

- 1 Press [**Input Ratio**].
- 2 Enter the desired ratio using the number keys.
- 3 Press the [**#**] key.
- 4 Press [**OK**].

## 3 Place originals, and then press the [**Start**] key.

### Auto Reduce/Enlarge

The machine can select an appropriate reproduction ratio based on the paper and original sizes you select.

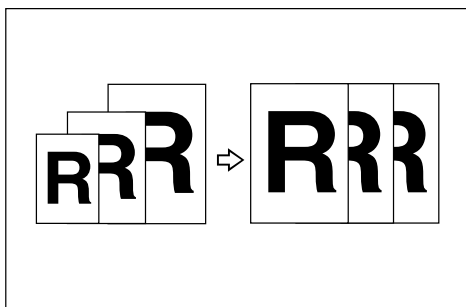

### Note

- When using Auto Reduce/Enlarge, see the following table for usable original sizes and orientations.

### ❖ Metric version

Where original is placed	Original size and orientation
Exposure glass	A3☐, B4☐, A4☐☐, A5☐, B5☐☐, 8 <sup>1</sup> / <sub>2</sub> " × 13"☐
ADF	A3☐, B4☐, A4☐☐, B5☐☐, A5☐☐, 8 <sup>1</sup> / <sub>2</sub> " × 11"☐☐, 8 <sup>1</sup> / <sub>2</sub> " × 13"☐, 11" × 17"☐, 8K☐, 16K☐☐

### ❖ Inch version

Where original is placed	Original size and orientation
Exposure glass	11" × 17"☐, 8 <sup>1</sup> / <sub>2</sub> " × 14"☐, 8 <sup>1</sup> / <sub>2</sub> " × 11"☐☐, 5 <sup>1</sup> / <sub>2</sub> " × 8 <sup>1</sup> / <sub>2</sub> "☐
ADF	A3☐, A4☐☐, 11" × 17"☐, 11" × 15"☐, 8 <sup>1</sup> / <sub>2</sub> " × 14"☐, 8 <sup>1</sup> / <sub>2</sub> " × 11"☐☐, 10" × 14"☐, 5 <sup>1</sup> / <sub>2</sub> " × 8 <sup>1</sup> / <sub>2</sub> "☐☐, 8" × 13"☐, 8" × 10"☐

### 🔍 Reference

For originals whose size is difficult to detect automatically, see p.9 "Sizes difficult to detect".

- 1** Press [Auto Reduce/Enlarge].
- 2** Select the paper tray.
- 3** Place originals, and then press the [Start] key.

## Size Magnification

This function calculates an enlargement or reduction ratio based on the lengths of the original and copy.

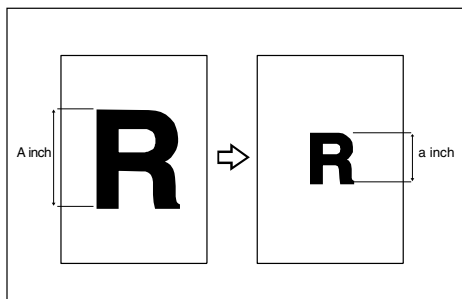

### Note

- Measure and specify the lengths of the original and copy by comparing “A” with “a.”
- You can enter sizes within the following ranges.

Metric version	1 – 999 mm (in 1 mm increments)
Inch version	0.1" – 99.9" (in 0.1" increments)

- 1** Press [Reduce/Enlarge].
- 2** Press [Size Mag.].
- 3** Enter the length of the original using the number keys, and then press [#] or the [#] key.

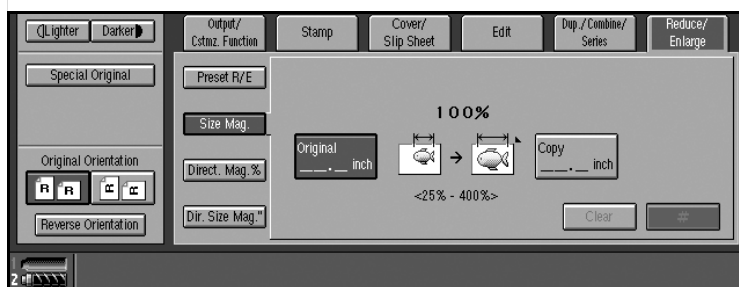

- 4** Enter the length of the copy using the number keys, and then press [#] or the [#] key.

### Note

- To change the length after pressing [#] or the [#] key, select [Original] or [Copy], and then enter the desired length.

- 5** Place originals, and then press the [Start] key.

## Directional Magnification (%)

Copies can be reduced or enlarged at different reproduction ratios, horizontally and vertically.

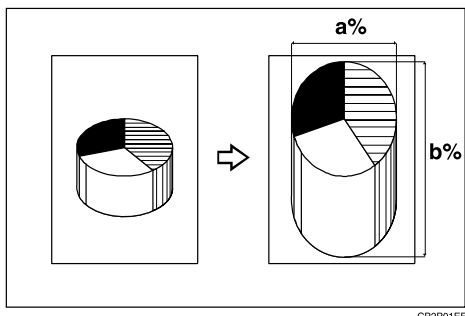

**a:** Horizontal ratio

**b:** Vertical ratio

### Note

- You can also select a preset ratio closest to the desired ratio using **[Reduce]** or **[Enlarge]**, and then adjust with **[+]** or **[-]**.
- You can set the ratio from 25 to 400% in 1% increments.

**1** Press **[Reduce/Enlarge]**.

**2** Press **[Direct. Mag.%]**.

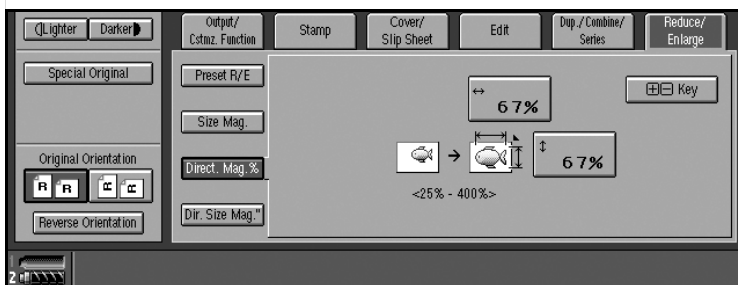

To enter a ratio using the number keys

- 1** Enter the desired horizontal ratio using the number keys, and then press **[#]** or the **[#]** key.
- 2** Enter the desired vertical ratio using the number keys, and then press **[#]** or the **[#]** key.

To specify a ratio with **[+]** and **[-]**

- 1** Press **[+- Key]**.

**2** Adjust the horizontal ratio using **[+]** or **[-]**.

**Note**

- Pressing **[+]** or **[-]** changes the ratio in 1% increments. Pressing and holding down **[+]** or **[-]** changes it in 10% increments.
- If you have entered a ratio incorrectly, readjust using **[+]** or **[-]**.

**3** Adjust the vertical ratio using **[+]** or **[-]**.

**3** Place originals, and then press the **[Start]** key.

2

## Directional Size Magnification (inch)

Optimal reproduction ratios are automatically selected when you enter the required horizontal and vertical lengths of the original and copy image.

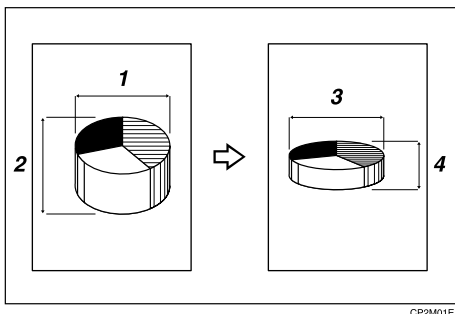

**1.** Horizontal original size

**2.** Vertical original size

**3.** Horizontal copy size

**4.** Vertical copy size

**Note**

- Specify the vertical and horizontal sizes of the original and those of the copy, as shown in the illustration.
- You can enter sizes within the following ranges.

Metric version	Vertical: 1 – 999 mm (in 1 mm increments) Horizontal: 1 – 999 mm (in 1 mm increments)
Inch version	Vertical: 0.1" – 99.9" (in 0.1" increments) Horizontal: 0.1" – 99.9" (in 0.1" increments)

**1** Press **[Reduce/Enlarge]**.

**2** Press **[Dir. Size Mag.]**.

- 3 Enter the horizontal size of the original using the number keys, and then press [#] or the [F] key.

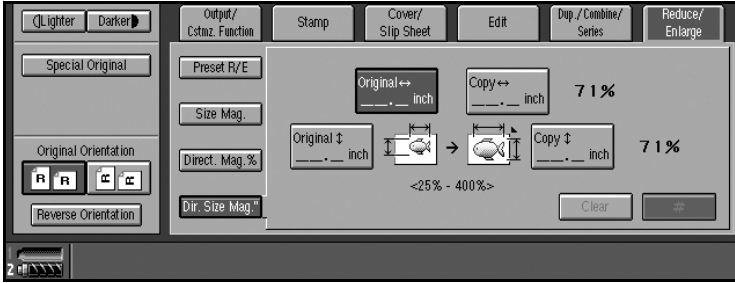

- 4 Enter the horizontal size of the copy using the number keys, and then press [#] or the [F] key.
- 5 Enter the vertical size of the original using the number keys, and then press [#].
- 6 Enter the vertical size of the copy using the number keys, and then press [#] or the [F] key.

**Note**

- To change a length, press the key you want to change and enter the new value.

- 7 Place originals, and then press the [Start] key.

---

## Sort

---

Each time copies of a set or those of a different job are delivered, the next copy set is shifted when delivered, so that you can separate sets or jobs.

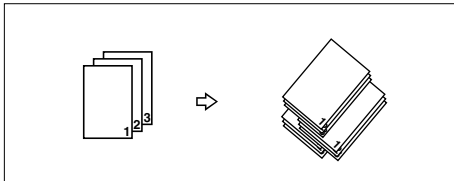

**Note**

- You can select whether to shift or not. See p.139 "Sort/Stack Shift Tray Setting".

**Reference**

For setting conditions, see p.139 "Memory Full Auto Scan Restart", p.139 "Sort/Stack Shift Tray Setting", and p.127 "Auto Tray Switching".

## 1 Press .

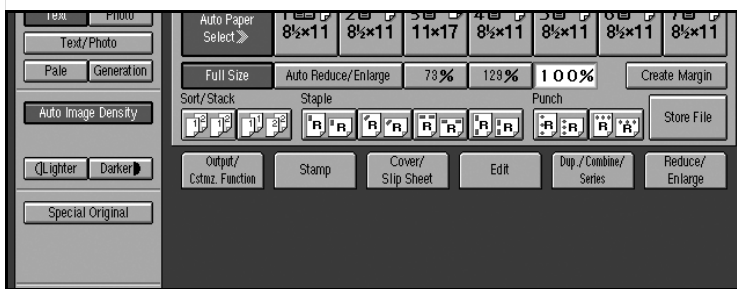

## 2 Enter the number of copy sets using the number keys.

### Note

- The maximum number of sets is 9999.
- To confirm the type of finishing, press the **[Sample Copy]** key. See p.43 "Sample copy".

## 3 Place originals, and then press the **[Start]** key.

### Note

- When placing an original on the exposure glass, start with the first page to be copied. When placing an original in the ADF, set so that the last page is on the bottom.
- When placing an original on the exposure glass or in the ADF using batch and SADP mode, press the **[#]** key after all the originals have been scanned.

## Sample copy

Use this function to check copy settings before making a long copy run.

### Note

- This function can be used only when the Sort function has been turned on.

## 1 Select Sort and any other required functions, and then place originals.

## 2 Press the **[Sample Copy]** key.

One copy set is made as a sample.

## 3 If the sample is acceptable, press **[Print]**.

The number of copies made is the number specified, minus one for the proof copy.

### Note

- If you press **[Suspend]** after checking the results, return to step 1 to adjust copy settings as necessary. You can change the settings for Staple, Punch, Margin Adjust, and Designate. However, depending on the combination of functions, you may not be able to change certain settings.
- Changing the image density which can do either lighter or darker for certain levels affects to print the rest of the pages.

---

## Changing the number of sets

---

You can change the number of copy sets during copying.

 **Note**

- This function can only be used when the Sort function is operative.

**1** When “Copying” is displayed, press the **[Stop]** key.

**2** Press **[Change Quantity]**.

 **Note**

- If you set one set of copy, you cannot change the number of sets.

**3** Enter the number of copy sets using the number keys, and then press the **[#]** key.

 **Note**

- The number of sets you can enter depends on when the **[Stop]** key is pressed.

**4** Press **[Continue]**.

Copying starts again.

---

## When memory is full

---

If the amount of data of the scanned originals exceeds the capacity of memory, scanning is interrupted.

 **Note**

- The number of pages that can be stored in memory is about 2000 pages of A4 size originals. It depends on the type of originals or memory settings.

 **Reference**

In Sort mode, you can complete scanning and copying by copying the scanned pages stored in memory until it becomes full, and then scanning and copying the remained originals. See p.139 “Memory Full Auto Scan Restart”.

**1** Press the **[Start]** key.

All scanned pages are copied, and data stored in memory are cleared.

**2** Remove the copies, and then continue copying following the instructions on the display.



---

## Shift tray off in sort/stack

---

- 1** Press [Output/Cstmz. Function].
- 2** Press [Sort/Stack Shift Tray Off].

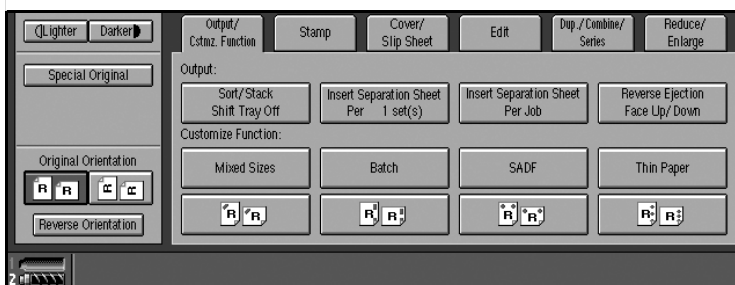

2

- 3** Place originals, and then press the [Start] key.

---

## Separation

---

Use this function to have separation sheets inserted between sets.

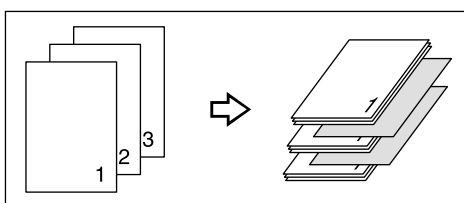

### Preparation

Before selecting this function, set the tray for separation sheets. See "Paper Tray Settings", *General Settings Guide*.

### Reference

You can select to have separation sheets inserted between every set, or every so many sets. See p.139 "Input/Output".

- 1** Press [Output/Cstmz. Function].
- 2** Press [Insert Separation Sheet Per 1 sets(s)] or [Insert Separation Sheet Per Job].
- 3** Place originals, and then press the [Start] key.

## Stack

This function collates copies of pages from a multi-page original. Stacks of each page's copies are shifted for ease of separation.

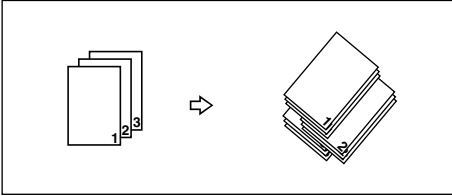

- 1** Press .
- 2** Enter the number of copies using the number keys.
- 3** Place originals, and then press the **[Start]** key.

 **Note**

- When placing originals on the exposure glass, start with the first page to be copied. When placing originals in the ADF, set so that the last page is on the bottom.
- When placing originals on the exposure glass or in the ADF using batch mode, press the **[#]** key after all have been scanned.

## Staple

Each copy set can be stapled together.

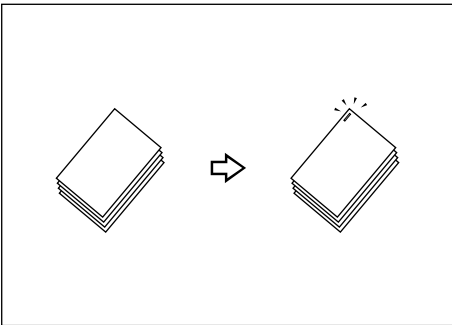



GCSTAP1E

 **Important**

- If you staple copies without the stapler cartridge for Saddle Stitch when using the booklet finisher, a paper misfeed may occur.

 **Note**

❑ The following types of paper cannot be stapled:

- Translucent paper
- OHP transparencies
- Label paper (adhesive labels)
- Coated paper
- Curled paper
- Highly flexible paper
- Paper of mixed sizes (differing horizontal dimensions, such as A4  and A3 )

 **Reference**









































































You can change the stapling position set on the staple keys. See p.139 “Select Staple Position”.





You can store the stapling position for the customize function, see p.109 “Customize function”.

## Stapling position and original setting

Place all originals in the ADF in the orientation in which they can be read normally. When placing the original on the exposure glass, keep the same orientation, but set the original facing downwards. When there is copy paper that is identical in size and orientation to the original, staple positions are as follows:

2

				Reverse Orientation + 	Reverse Orientation + 	Staple position <sup>*1</sup>
	Top Left					
						
	Top Left slant					
						
	Bottom Left					
						
	Left 2					
						
	Top 2					
						
	Top Right					
						
	Right 2					
						
	Saddle Stitch <sup>*3</sup>					
						

- \*1 This table shows staple positioning. The orientation of the paper does not indicate direction of delivery.
- \*2 You cannot staple at this position when copying onto A3  (11" × 17" ) or B4  (8 1/2" × 14" ) size paper.
- \*3 Saddle stitch is available only on the booklet finisher.

## 1 Select one of the stapling positions.

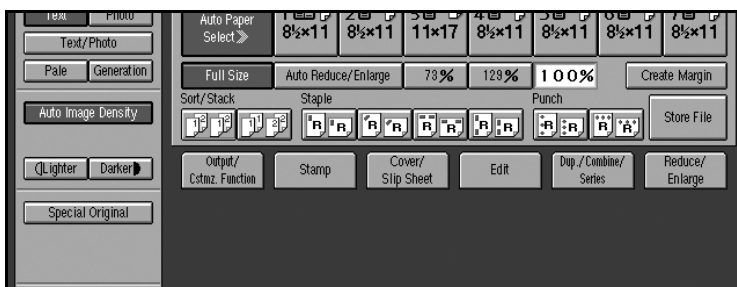

### Note

- When you select the stapling position, Sort mode is automatically selected.

### Reference

p.48 "Stapling position and original setting"

## 2 Enter the number of copy sets using the number keys.

## 3 Place originals, and then press the **[Start]** key.

### Note

- When placing originals on the exposure glass, start with the first page to be copied. When placing originals in the ADF, set so that the last page is on the bottom.
- When placing originals on the exposure glass or in the ADF using batch or SADF mode, press the **[#]** key after all have been scanned.

## Punch

The optional finisher and punch unit are required to use this function.  
This function makes punch holes in copies.

### ◆ 2 holes

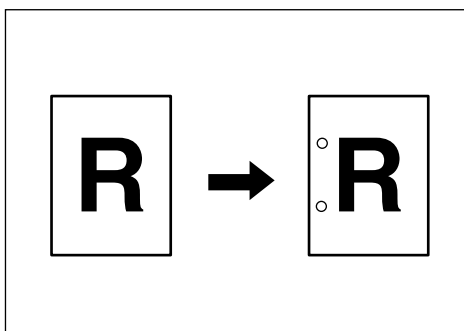

GCPNCH1E

### ◆ 3 holes

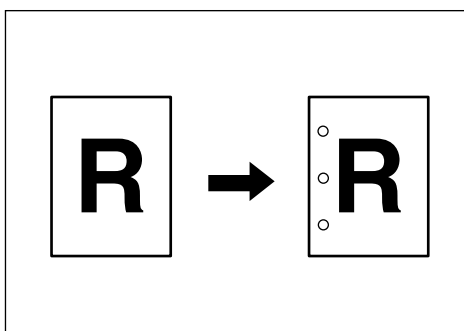

GCPNCH3E

### ◆ 4 holes

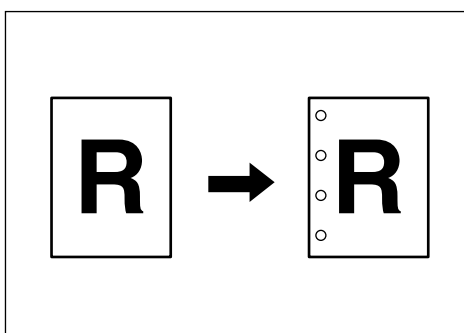

GCPNCH0E

### Note

















































- The 4 - hole punch type is only capable of punching in the 4 - hole format.

## Reference

You can change the punch type set on the punch keys. See p.140 “Select Punch Type”.

When you want to punch on the right, see p.130 “Customize Function: Copy”.

### Punch hole positions

		Orientation in which original is set		Punch hole positions	
		Exposure glass	ADF		
Standard	2 holes				
					
					
					
	3 holes				
					
					
					
	4 holes				
					
					
					

		Orientation in which original is set		Punch hole positions	
		Exposure glass	ADF		
90° Turn	2 holes				
	3 holes				
	4 holes				

The above table shows the punch hole positions. The orientation of the paper does not indicate direction of delivery.

**1** Select the punch position.

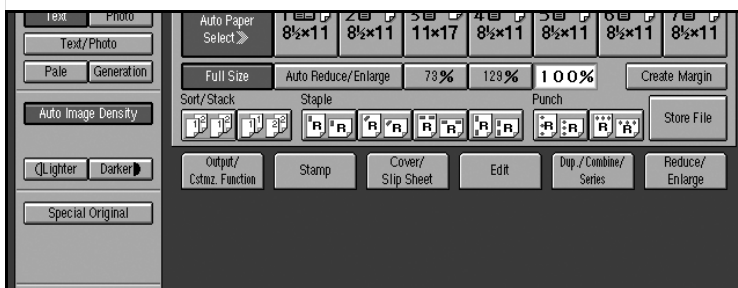



**2** Place the originals, and then press the **[Start]** key.

 **Note**

- For 90° turn punch type, press .

## Duplex

There are two types of duplex.

 **Note**

- You cannot use the following copy paper with this function:

- Paper smaller than A5,  $5\frac{1}{2}'' \times 8\frac{1}{2}''$
- Paper thicker than  $163 \text{ g/m}^2$ , 40 lb.
- Paper thinner than  $64 \text{ g/m}^2$ , 17 lb.
- Tab stock
- Translucent paper
- Label paper (adhesive labels)
- OHP transparencies

❖ **1 Sided → 2 Sided**

Copies 2 one-sided pages onto 1 two-sided page.

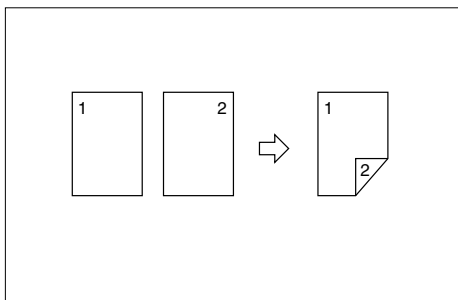

❖ **2 Sided → 2 Sided**

Copies 1 two-sided page onto 1 two-sided page.

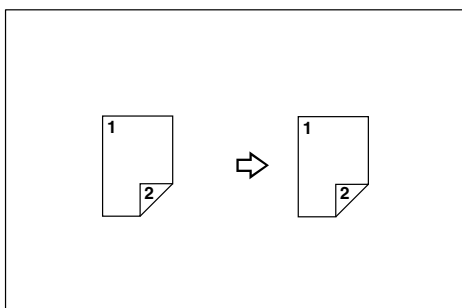

## Originals and copy orientation

You can select the orientation to copy two-sided originals onto two-sided pages.

- Top to Top

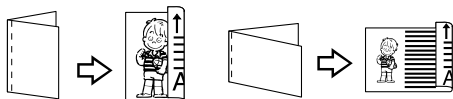

Duplex1

- Top to Bottom

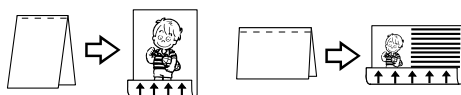

Duplex2

### Note

- ❑ The Default is **[Top to Top]**. You can change the default orientation with the User Tools. See p.126 “Original Orientation in Duplex Mode”.

**1** Press **[Dup./Combine/Series]**.

**2** Check that **[Duplex]** is selected.

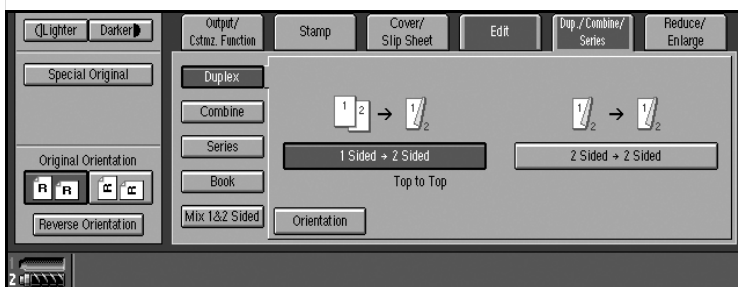

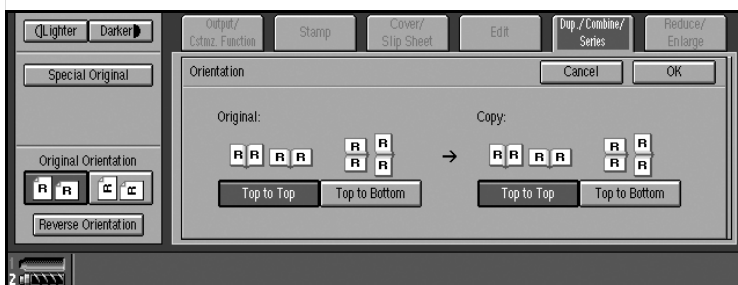

**3** Press **[Orientation]**, and then select orientation for Original and Copy.













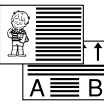

**4** Press **[OK]**.

**5** Place originals, and then press the **[Start]** key.

## Original orientation and completed copies

The resulting copy image will differ according to the orientation in which you place originals (widthwise , or lengthwise )

Original	How to set your original	Copy
Vertical 	Standard 	Top to Top 
	90° turn 	Top to Bottom 
	Reverse Orientation 	
Horizontal 	Standard 	Top to Top 
	90° turn 	Top to Bottom 
	Reverse Orientation 	

GCRYOU1E

The above table shows the orientation of images on the front and back of copies, not the direction of delivery.

### Note

- The paper used for duplex is 64 to 163 g/m<sup>2</sup>.

### Reference

The images are copied shifted by the set margin. You can change the position and size of the margin. See p.74 "Margin Adjustment", p.132 "1→2 sided Auto Back Side Margins:T to T", and p.132 "1→2 sided Auto Back Side Margins :T to B".

- 1** Press [Dup./Combine/Series].
- 2** Check that [Duplex] is selected.
- 3** Select the duplex type (1 Sided→2 Sided/2 Sided→ 2 Sided).
- 4** Press [Orientation], and then select orientation.
- 5** Press [OK].

**6** Place originals, and then press the **[Start]** key.

**Note**

- When placing originals on the exposure glass, start with the first page to be copied. When placing originals in the ADF, set so that the last page is on the bottom.
- When placing originals on the exposure glass or in the ADF using batch or SADF mode, press the **[#]** key after all have been scanned.

2

---

## 1 Sided Combine

---

Combine several pages onto one side of a sheet.

❖ **1 Sided, 2 Pages → Combine 1 Side**

Copies 2 one-sided originals to one side of a sheet.

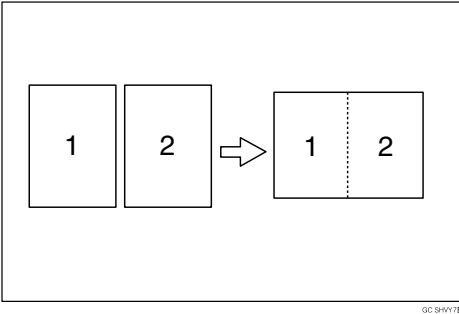

❖ **1 Sided, 4 Pages → Combine 1 Side**

Copies 4 one-sided originals to one side of a sheet.

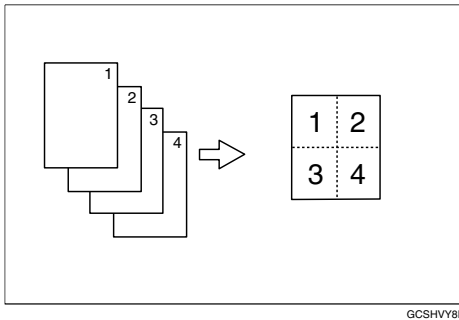

❖ **1 Sided, 8 Pages → Combine 1 Side**

Copies 8 one-sided originals to one side of a sheet.

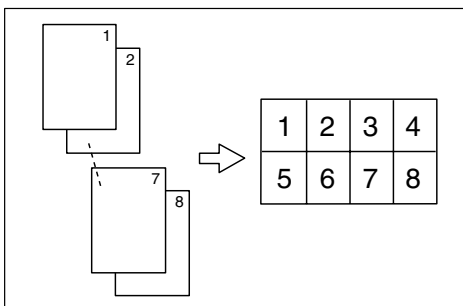

GCSHVY3E

2

❖ **2 Sided, 1 Page → Combine 1 Side**

Copies 1 two-sided original to one side of a sheet.

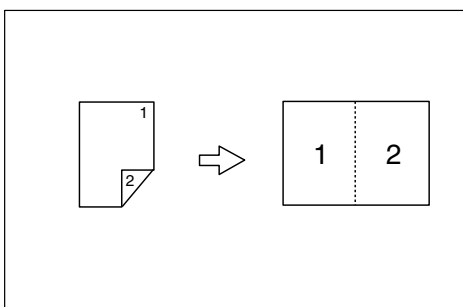

GCSHVYOE

❖ **2 Sided, 2 Pages → Combine 1 Side**

Copies 2 two-sided originals to one side of a sheet.

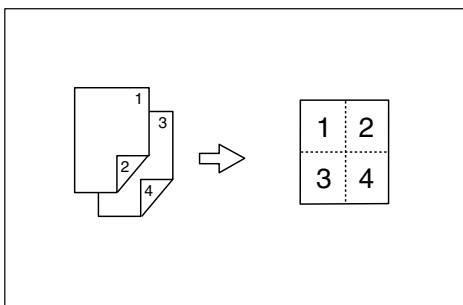

GCSHVYBE

❖ **2 Sided, 4 Pages → Combine 1 Side**

Copies 4 two-sided originals to one side of a sheet.

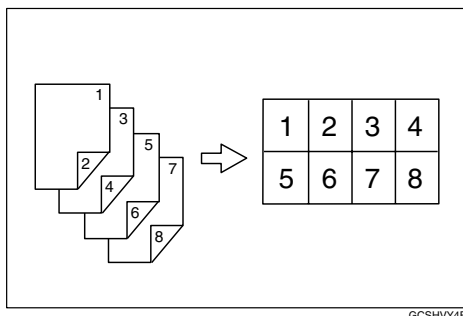

GCSHVY4E

❖ **Orientation of the Original and Image Position of Combine**

- Open to Left  Originals

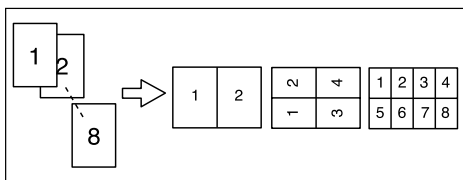

GCSHUY1E

- Open to Top  Originals

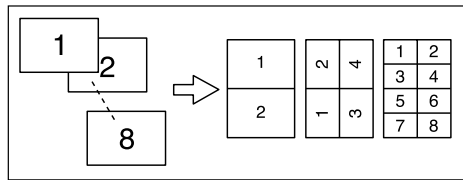

GCSHUY2E

 **Reference**

You can insert lines to separate images. See p.134 “Separation Line in Combine”.

You can erase a 3 mm (0.1 inch) boundary margin around all four edges of originals in Combine mode. See p.132 “Erase Original Shadow in Combine”.

You can set the copy order in Combine mode. See p.135 “Copy Order in Combine”.

- 1** Press [Dup./Combine/Series].

## 2 Press [Combine].

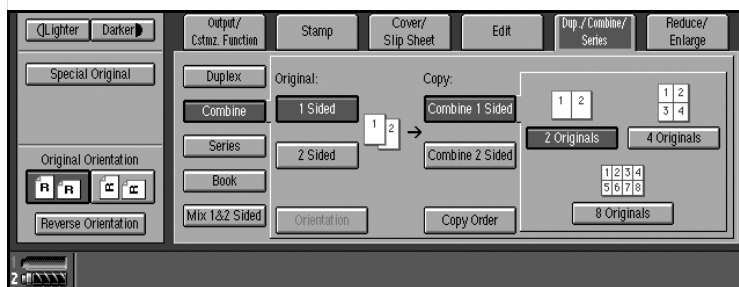

## 3 Check that [Combine 1 Sided] is selected, and then press [1 Sided] or [2 Sided].

To change the copy order

### 1 Press [Copy Order].

### 2 Select copy order, and then press [OK].

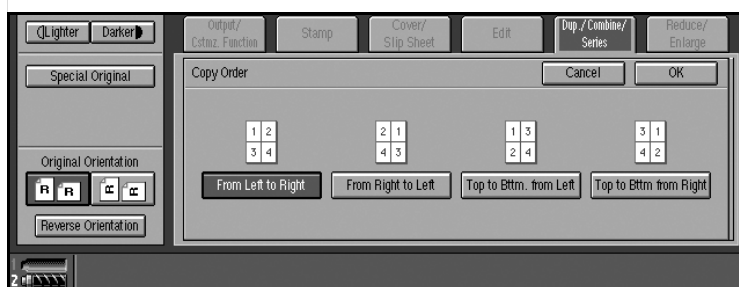

## 4 Select the number of originals to combine.

## 5 Select the paper size.

## 6 Place originals, and then press the [Start] key.

## 2 Sided Combine

Combines various pages of originals onto one sheet sides.

❖ **1 Sided, 4 Pages → Combine 2 Side**

Copies 4 one-sided originals to one sheet with two pages per side.

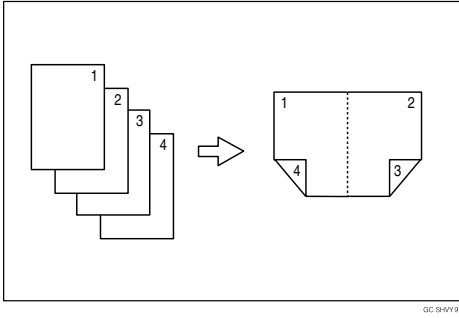

❖ **1 Sided, 8 Pages → Combine 2 Side**

Copies 8 one-sided originals to one sheet with four pages per side.

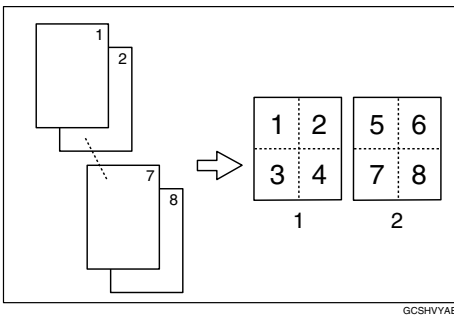

1. Front

2. Back

❖ **1 Sided, 16 Pages → Combine 2 Side**

Copies 16 one-sided originals to one sheet with eight pages per side.

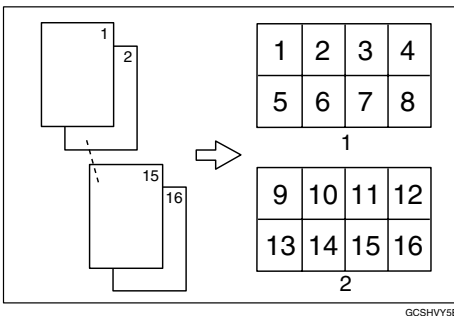

1. Front

2. Back



### ❖ 2 Sided, 4 Pages → Combine 2 Side

Copies 2 two-sided originals to one sheet with two pages per side.

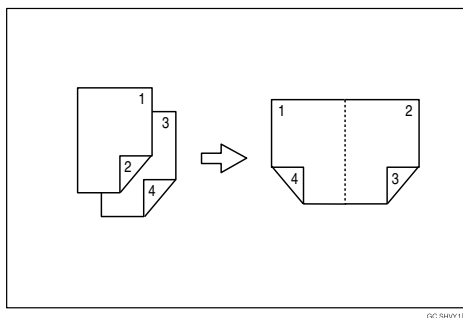

2

### ❖ 2 Sided, 8 Pages → Combine 2 Side

Copies 4 two-sided originals to one sheet with four pages per side.

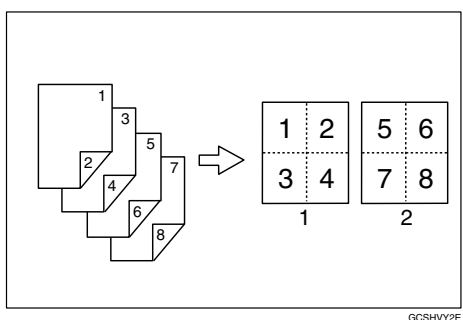

#### 1. Front

#### 2. Back

### ❖ 2 Sided, 16 Pages → Combine 2 Side

Copies 8 two-sided originals to one sheet with eight pages per side.

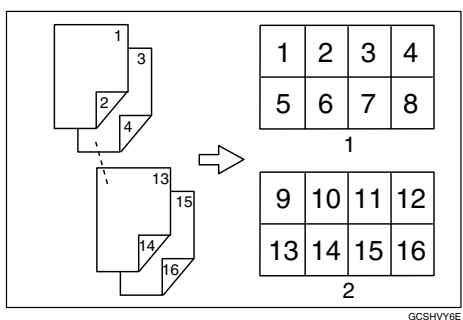

#### 1. Front

#### 2. Back

#### 🔍 Reference

p.58 "Orientation of the Original and Image Position of Combine".

For related initial settings, see p.132 "Erase Original Shadow in Combine",

p.135 "Copy Order in Combine", and p.134 "Separation Line in Combine".

- 1** Press [Dup./Combine/Series].
- 2** Press [Combine].
- 3** Press [Combine 2 Sided], and then press [1 Sided] or [2 Sided] for originals.

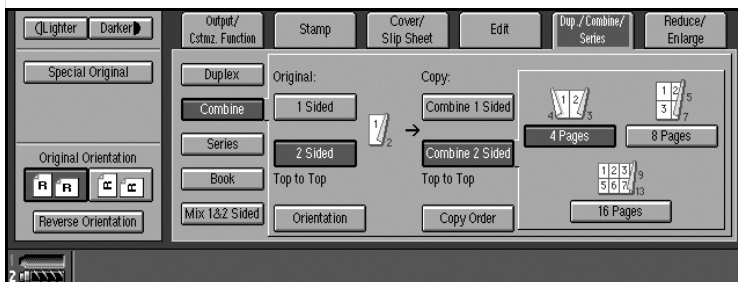

### Reference

To change the orientation of original and copy, press [Orientation]. See p.54 "Originals and copy orientation".

---

To change the copy order

---

- 1** Press [Copy Order].
- 2** Select copy order, and then press [OK].
- 4** Select the number of originals to combine.
- 5** Select the paper size.
- 6** Place originals, and then press the [Start] key.

## Series Copies

Separately copies the front and back of a two-sided original, or the two facing pages of a bound original onto two sheets.

### ◆ 2 Sided → 1 Sided

You can make one-sided copies from two-sided originals.

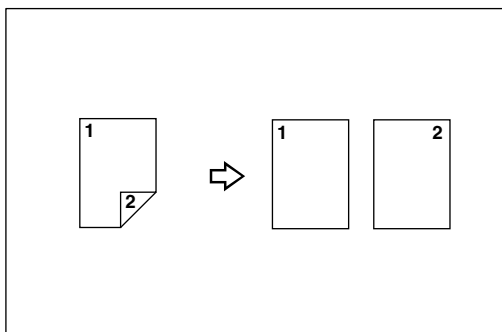

### ◆ Book → 1 Sided

You can make one-sided copies from two facing pages of a bound original (book).

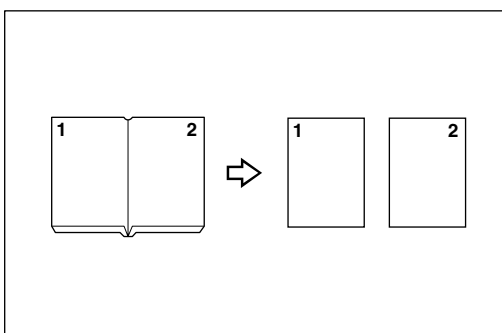





### 📎 Note

- See the following table when you select original and copy paper sizes with a 100 % ratio.

### ◆ Metric version

Original	Copy paper
A3	A4  × 2 sheets
B4	B5  × 2 sheets
A4	A5  × 2 sheets

### ❖ Inch version

Original	Copy paper
11" × 17" 	8 <sup>1</sup> / <sub>2</sub> " × 11"  × 2 sheets
8 <sup>1</sup> / <sub>2</sub> " × 11" 	5 <sup>1</sup> / <sub>2</sub> " × 8 <sup>1</sup> / <sub>2</sub> "  × 2 sheets

**1** Press [Dup./Combine/Series].

**2** Press [Series].

**3** Press [2 Sided → 1 Sided] or [Book → 1 Sided].

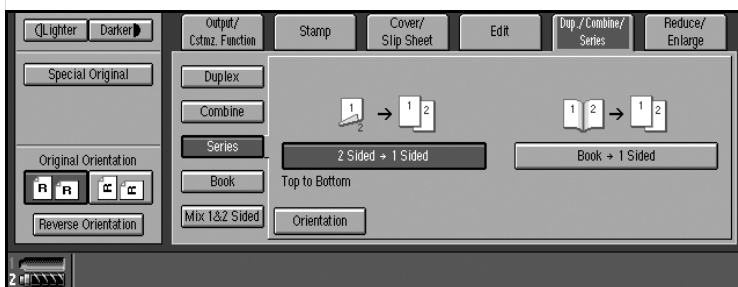

### Reference

If you select [2 Sided → 1 Sided] and want to change the orientation, press [Orientation]. See p.54 “Originals and copy orientation”.

**4** Check that [Auto Paper Select] is selected.

### Note

The default is “Top to Top”. You can change this setting with the User Tools. See p.126 “Original Orientation in Duplex Mode”.

**5** Place originals, and then press the [Start] key.

### Note

When all originals are scanned, press the [#] key.

## Copying Book Originals

A book is made by copying two or more originals in page order.

### ❖ Book → 2 Sided

Copies a two-page spread original onto both sides of a sheet.

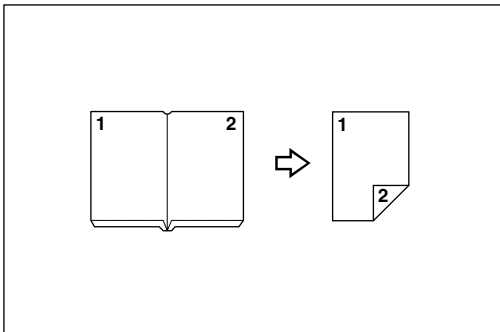

### ❖ Multi → 2 Sided

Copies each two-page spread original as it is onto both sides of a sheet.

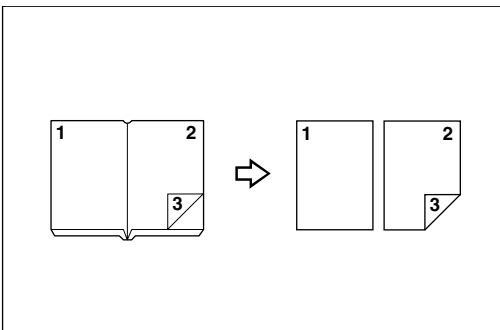

### ❖ Booklet

Make copies in page order for a folded booklet.

- 1 Sided → Booklet

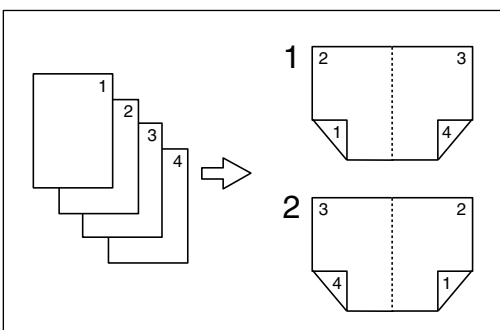

GCB00K9E

1. Open to Left
2. Open to Right

- 2 Sided → Booklet

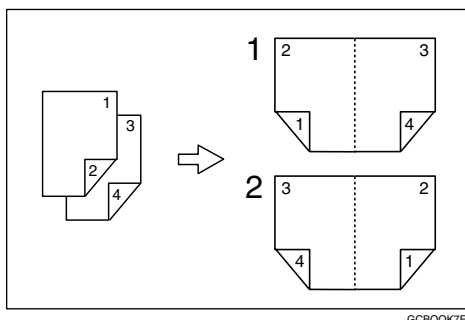

GCBOOK7E

1. Open to Left

2. Open to Right

◆ Magazine

Copies two or more originals to make copies in page order (for when they are folded and stacked).

- 1 Sided → Booklet

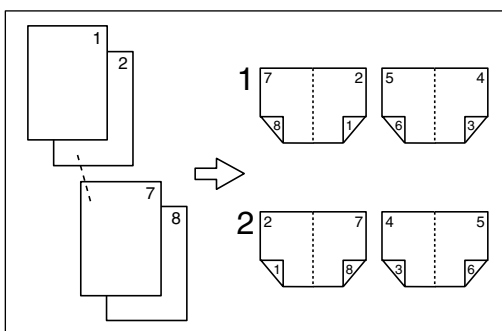

GCBOOK10E

1. Open to Left

2. Open to Right

- 2 Sided → Magazine

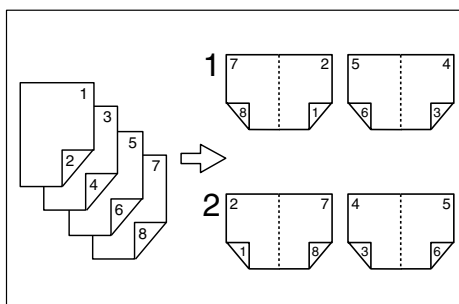

GCBOOK8E

1. Open to Left

2. Open to Right

**Note**

- The machine sets the reproduction ratio automatically to match the paper size and copies the originals together onto the paper.

**❖ Metric version**

Original	Copy paper
A3	A4 (2-sided)
B4	B5 (2-sided)
A4	A5 (2-sided)

**❖ Inch version**

Original	Copy paper
11" × 17"	8 <sup>1</sup> / <sub>2</sub> " × 11" (2-sided)
8 <sup>1</sup> / <sub>2</sub> " × 11"	5 <sup>1</sup> / <sub>2</sub> " × 8 <sup>1</sup> / <sub>2</sub> " (2-sided)

**Book → 2 Sided**

- 1 Press [Dup./Combine/Series].
- 2 Press [Book].
- 3 Press [Left and Right → 2 Sided].

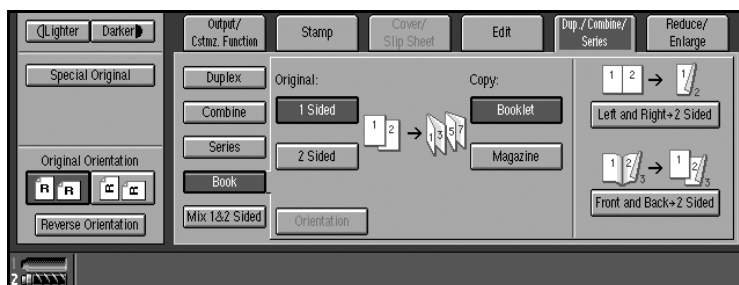
**Reference**

To change the orientation of original and copy, press [Orientation]. See p.54 "Originals and copy orientation".

- 4 Place originals, and press the [Start] key.

---

**Multi → 2 Sided**

---

- 1** Press [Dup./Combine/Series].
- 2** Press [Book].
- 3** Press [Front and Back → 2 Sided].

 **Reference**

To change the orientation of original and copy, press [Orientation]. See p.54 "Originals and copy orientation".

- 4** Place originals, and press the [Start] key.
- 

**Booklet**

---

❖ **How to fold copies to make a booklet**

Fold the copy so that a crease is in the center and open as shown in the following illustrations:

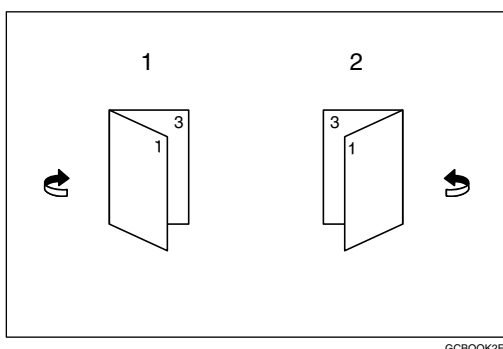

1. Open to left
2. Open to right

 **Note**

- In this mode, the machine automatically sets the reproduction ratio to match the paper size and copies the originals together onto the paper.

 **Reference**

You can erase a 3 mm (0.1 inch) boundary margin around all four edges of originals in Combine mode. See p.132 "Erase Original Shadow in Combine".

You can insert lines to separate images. See p.134 "Separation Line in Combine".

- 1** Set the orientation with the User Tools.

 **Reference**

p.135 "Orientation: Booklet, Magazine"



- 2 Press [Dup./Combine/Series].
- 3 Press [Book].
- 4 Press [1 Sided] or [2 Sided] for originals.

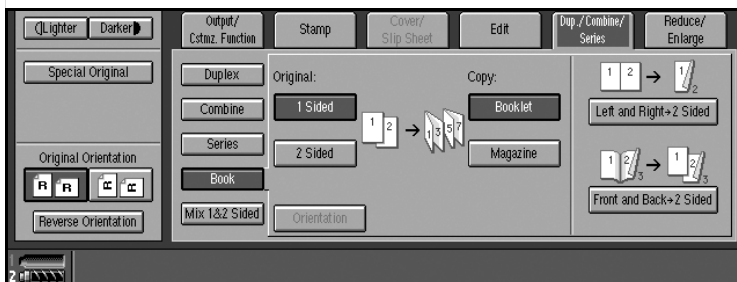

- 5 Press [Booklet].
- 6 Select the paper size.
- 7 Place originals, and then press the [Start] key.

#### Note

- When placing originals on the exposure glass or in the ADF in Batch mode, press the [#] key after all originals are scanned.

## Magazine

### ◆ How to fold and stack copies to make a magazine

Fold and stack copies to make a magazine, and open as shown in the following illustrations:

- Open to left

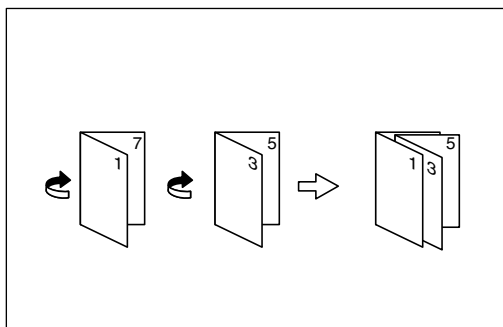

GCBOOK5E

- Open to right

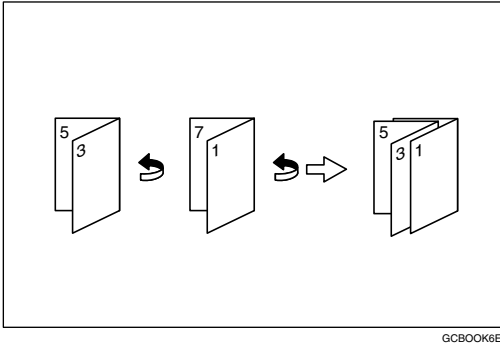

GCB006E

**Note**

- In this mode, the machine sets the reproduction ratio automatically to match the paper size and copies the originals together onto the paper.

**Reference**

You can erase a 3 mm (0.1 inch) boundary margin around all four edges of originals in Combine mode. See p.132 “Erase Original Shadow in Combine”.  
 You can insert lines to separate images. See p.134 “Separation Line in Combine”.

**1 Set the orientation with the User Tools.**

**Reference**

p.135 “Orientation: Booklet, Magazine”

**2 Press [Dup./Combine/Series].**

**3 Press [Book].**

**4 Press [1 Sided] or [2 Sided].**

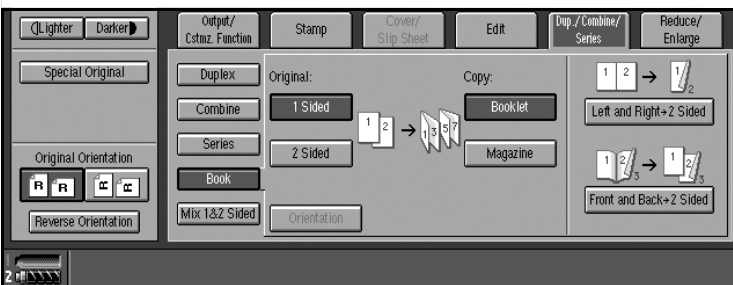

**5 Press [Magazine].**

**6 Select the paper size.**

**7 Place originals, and then press the [Start] key.**

**Note**

- When placing originals on the exposure glass or in the ADF in batch or SADf mode, press the [#] key after all originals are scanned.

## Mix 1 & 2 Sided

You can copy two types of original, one-sided and two-sided, onto one or both sides of a sheet.

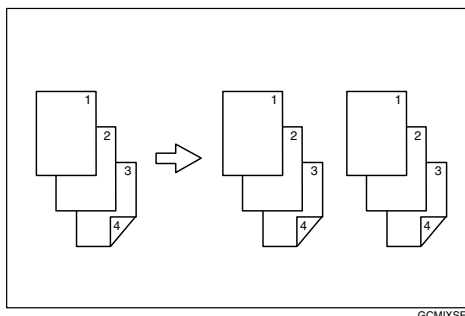

GCMIXSE

### Note

- You can scan originals from the exposure glass, batch mode or SADF mode.
- You cannot combine with sample copy or designate function.

**1** Press [Dup./Combine/Series].

**2** Press [Mix 1&2 Sided].

**3** Place originals.

**4** Select the type of original.

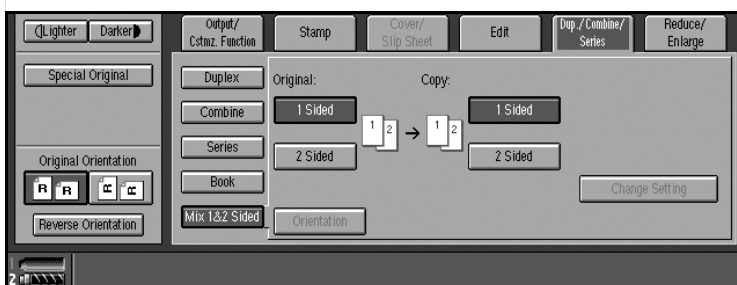

**5** Select the type of copy.

**6** Press the [Start] key.

**7** Place the next originals, and then repeat steps **4** to **6**.

### Note

- Press [Change Settings] if the originals end in odd page or when you want to change the copy page manually.
- [Specify Pages to Print in Duplex] function is available for jobs stored by selecting [Store File].

## Scanning Position

You can move the scanned position of each originals.

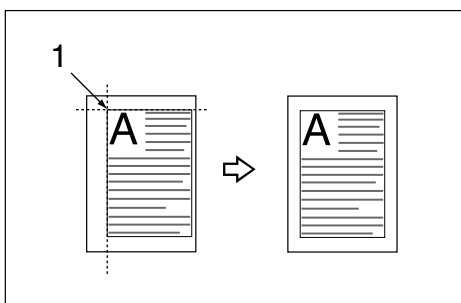

**1. Point where the machine starts scanning.**

### Note

You can move the scanned position up from 0 to 30 mm (in 1 mm increments), 0 to 1.2 inch (in 0.1 inch increments) upward, downward, left and right.

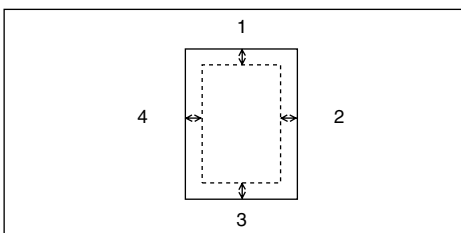

**1. Top: 0 – 30 mm (0" – 1.2")**

**2. Right: 0 – 30 mm (0" – 1.2")**

**3. Bottom: 0 – 30 mm (0" – 1.2")**

**4. Left: 0 – 30 mm (0" – 1.2")**

**1** Press [Edit].

**2** Press [Scan Position].

- 3** Set the scan position for the face of the original. Press [↑] or [↓] to set the top or bottom position. Press [←] or [→] to set the left or right position.

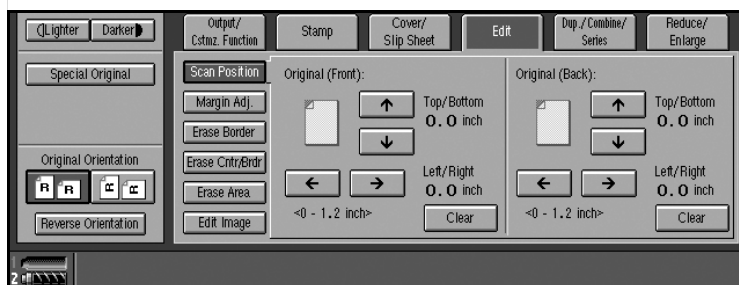

**Note**

- If you have incorrectly set the position, readjust with [↑], [↓], [←], or [→].
- If you do not need to set the scan position of the back of the original, proceed to step **5**.

- 4** Set the scan position for the back of the original. Press [↑] or [↓] to set the top or bottom position. Press [←] or [→] to set the left or right position.

**Note**

- The scan position set here for the back of originals is valid when you copy 2-sided originals.

- 5** Place originals, and then press the **[Start]** key.

## Margin Adjustment

You can shift the image to the left, right, top or bottom to make a binding margin.

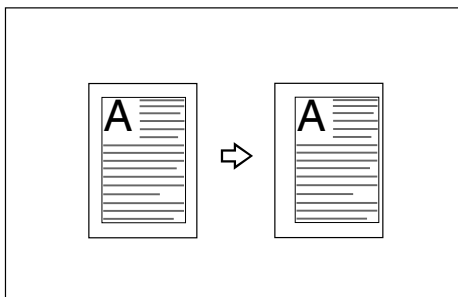

### Reference

For initial settings, see p.131 “Front Page Margin : Left/Right”, p.131 “Back Side Margins : Left/Right”, p.132 “Front Side Margin : Top/Bottom”, and p.132 “Back Side Margin : Top/Bottom”.

### Note

- You can change the width of the binding margin up to 30 mm in 1 mm increments (1.2 inch in 0.1 inch steps) upward, downward, left and right.

**1** Press [Edit].

**2** Press [Margin Adj.].

**3** Set a binding margin for a front page. Press [←] and [→] when setting the left and right margins, and [↓] and [↑] when setting the top and bottom margins.

### Note

- To change the value entered, press [←], [→], [↓], and [↑] to set the new value.
- If you do not need to specify margins for the back side pages, proceed to step **5**.

**4** Set a binding margin for the back side pages. Press [←] and [→] when setting the left and right margins, and [↓] and [↑] when setting the top and bottom margins.

### Note

- Margin on the back side of the page is available only when [Duplex], [1 Sided Combine] or [2 Sided Combine] is selected.

**5** Place originals, and then press the [Start] key.

---

## Erase

---

This function erases the center and/or all four sides of the original image. This function also erases the inside or outside of a specified area.

This function has the following three types:

❖ **Border**

This mode erases edge margin of the original image.

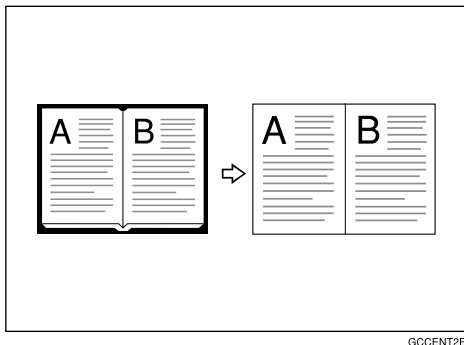

❖ **Center/Border**

This mode erases both the center and edge margins from an original image.

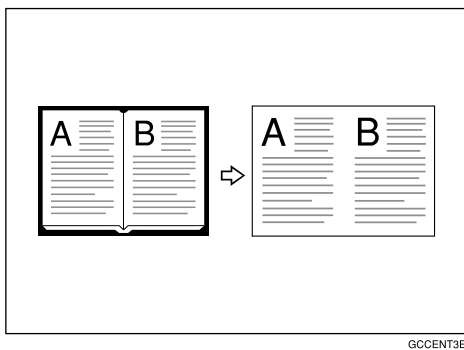

❖ **Inside**

This mode blanks out a designated area of the copy image.

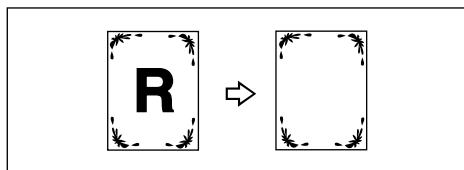

❖ **Outside**

This mode blanks out all areas of the copy image except the area you specify.

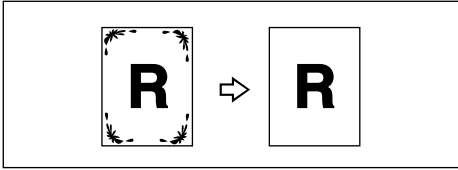

2

🔍 **Reference**

The erase width in the **[Border]**, **[Center]**, and **[Center/Border]** modes is set to 10 mm (0.4") by default. You can change this settings with the User Tools. See p.132 "Erase Border Width".

 **Note**

❑ The relation between the original orientation and the erased part is as follows:

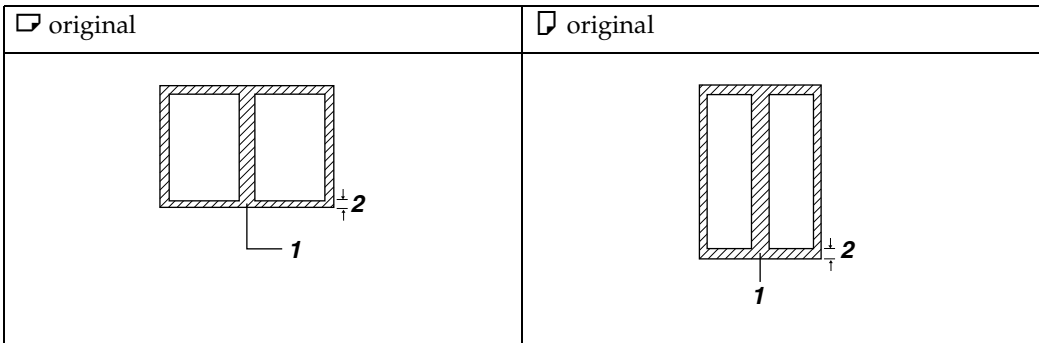

1. Erased part
2. 2 – 99 mm (0.1" – 3.9")

---

**Border Erase**

---

- 1** Press **[Edit]**.
- 2** Press **[Erase Border]**.
- 3** Set an erase border width.

---

Selecting **[Same Width]**

---

- 1** Press **[Same Width]**.
- 2** Set an erase border width using **[+]** and **[-]**.

 **Note**

❑ To change the value entered, press **[+]** and **[-]** to set the new value.



---

## Selecting [Diff. Width]

---

**1** Press [Diff. Width].

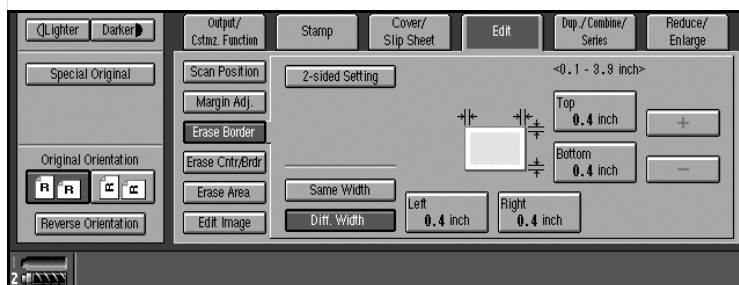

**2** Press the key for the border you want to change, and then set an erase border width using [+ ] and [ - ].

**4** Press [2-sided Setting], and then [Original (Back)].

**Note**

- If you do not need to erase the border on the back of the original, proceed to step **6**.

**5** Set the border to be erased the back.

**Note**

- Erasing the border on the back is valid only when you copy two-sided originals.

**6** Place originals, and then press the [Start] key.

---

## Center/border erase

---

**1** Press [Edit].

**2** Press [Erase Cntr/Brdr.].

**3** Set the border to be erased.

## Selecting [Same Width]

- 1 Press [Same Width].

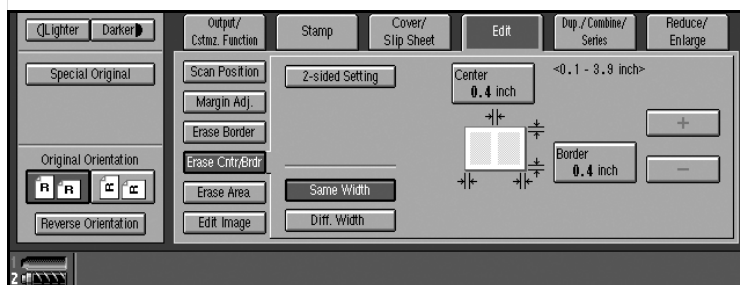

- 2 Press [Center], and then set the erase center width using [+ ] and [- ].
- 3 Press [Border], and then set the erase border width using [+ ] and [- ].

## Selecting [Diff. Width]

- 1 Press [Diff. Width].

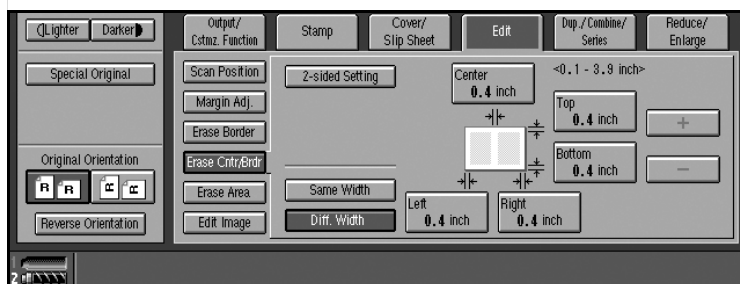

- 2 Press the key for the part you want to change, and then set an erase margin width with [+ ] and [- ].
- 4 Press [2-sided Setting] and [Original (Back)].
  - Note**
  - If you do not need to erase the center or border on the back of the original, proceed to step 6.
- 5 Set the center or border to be erased on the back.
  - Note**
  - Erasing the center or border on the back is valid only when you copy two-sided originals.
- 6 Place originals, and then press the [Start] key.

## Inside erase

Decide where the machine starts (X1, Y1) and stops erasing (X2, Y2).

### Note

- You can input lengths of 0 – 432 mm (0 – 17 inch).

- 1** Press [Edit].
- 2** Press [Erase Area].
- 3** Press [Erase Inside 1] or [Erase Inside 2].
- 4** Enter the value of [X1] using the number keys, and then press [#] or the [#] key.

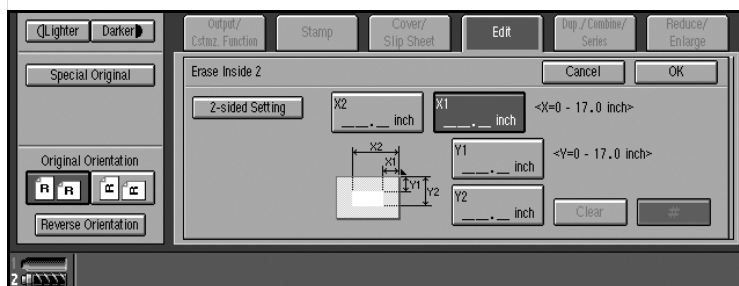

- 5** Enter the value of [Y1] using the number keys, and then press [#] or the [#] key.
- 6** Enter the value of [X2] using the number keys, and then press [#] or the [#] key.
- 7** Enter the value of [Y2] using the number keys, and then press [#] or the [#] key.
- 8** Press [2-sided Setting] and [Original (Back)].

### Note

- If you do not need to erase the image on the back, proceed to step 10.

- 9** Enter the values of [X1], [Y1], [X2], and [Y2] for the back.

### Note

- Erasing the image on the back of originals is valid when you copy two-sided originals.

- 10** Press [OK].
- 11** Place originals, and then press the [Start] key.

## Outside erase

Decide where the machine starts (X1, Y1) and stops erasing (X2, Y2).

### Note

- You can input lengths of 0 – 432 mm (0 – 17 inch).

**1** Press [Edit].

**2** Press [Erase Area].

**3** Press [Erase Outside].

**4** Enter the value of [X1] using the number keys, and then press [#] or the [#] key.

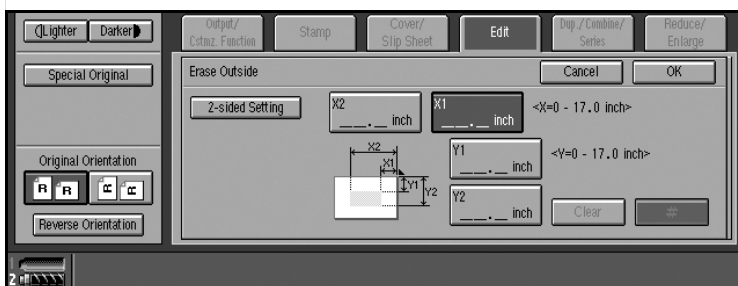

**5** Enter the value of [Y1] using the number keys, and then press [#] or the [#] key.

**6** Enter the value of [X2] using the number keys, and then press [#] or the [#] key.

**7** Enter the value of [Y2] using the number keys, and then press [#] or the [#] key.

**8** Press [2-sided Setting] and [Original (Back)].

### Note

- If you do not need to erase the image on the back of originals, proceed to step 10.

**9** Enter the values of [X1], [Y1], [X2], and [Y2] for the back.

### Note

- Erasing the image on the back of originals is valid when you copy two-sided originals.

**10** Press [OK].

**11** Place originals, and then press the [Start] key.

## 3 Edges Full Bleed

You can make full image copy by cutting down the top, bottom, and right side margins. This function is useful for densely-filled originals.

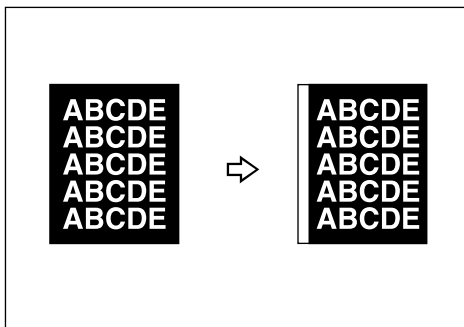

GCBLEET

- 1** Press [Edit].
- 2** Press [Edit Image].
- 3** Press [3 Edges Full Bleed].

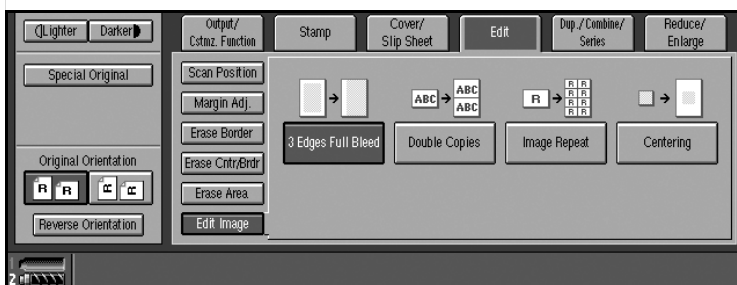

- 4** Place originals, and then press the [Start] key.

## Double Copies

An original image is copied twice onto one copy, as shown in the illustration.

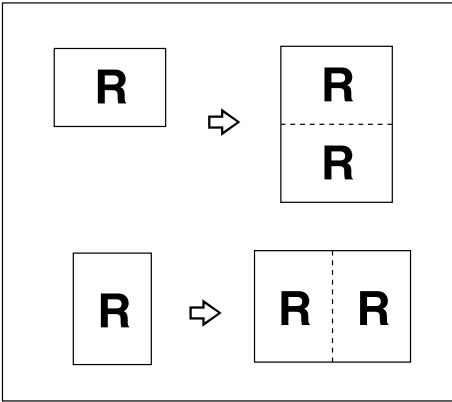

**Note**

- ❑ See the following table for original and copy paper sizes when using a 100% ratio. Originals of size A5 (5<sup>1</sup>/<sub>2</sub>" × 8<sup>1</sup>/<sub>2</sub>" ) cannot be detected properly on the exposure glass. Be sure to manually select such copy paper, or place the originals in the ADF.

❖ **Metric version**

Original size and orientation	Copy paper size and orientation
A5	A4
A4	A3
A5	A4

❖ **Inch version**

Original size and orientation	Copy paper size and orientation
5 <sup>1</sup> / <sub>2</sub> " × 8 <sup>1</sup> / <sub>2</sub> "	8 <sup>1</sup> / <sub>2</sub> " × 11"
5 <sup>1</sup> / <sub>2</sub> " × 8 <sup>1</sup> / <sub>2</sub> "	8 <sup>1</sup> / <sub>2</sub> " × 11"
8 <sup>1</sup> / <sub>2</sub> " × 11"	11" × 17"

**Reference**

For selecting a separation line, see p.133 "Double Copies Separation Line".

- 1** Press [Edit].
- 2** Press [Edit Image].
- 3** Press [Double Copies].
- 4** Select the paper size.
- 5** Place originals, and then press the [Start] key.

## Image Repeat



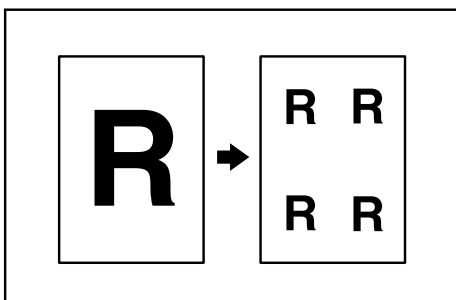













The original image is copied repeatedly.

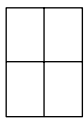
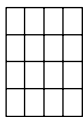

2

### Note

- The number of repeated images depends on original size, copy paper size, and reproduction ratio. See the following table.

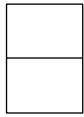
	Metric version	Inch version
	Original / Copy paper	Original / Copy Paper
	A5  / A4  A5  / A4 	$5\frac{1}{2}'' \times 8\frac{1}{2}''$  / $8\frac{1}{2}'' \times 11''$  $5\frac{1}{2}'' \times 8\frac{1}{2}''$  / $8\frac{1}{2}'' \times 11''$ 
4 repeats  Repeat 1	71%	65%
16 repeats  Repeat 2	35%	32%
	A5  / A4  A5  / A4 	$5\frac{1}{2}'' \times 8\frac{1}{2}''$  / $8\frac{1}{2}'' \times 11''$  $5\frac{1}{2}'' \times 8\frac{1}{2}''$  / $8\frac{1}{2}'' \times 11''$ 
2 repeats  Repeat 3	100%	

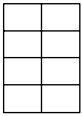
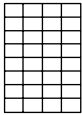
	Metric version	Inch version
8 repeats  Repeat 4	50%	
32 repeats  Repeat 5	25%	

### Reference

For selecting a separation line, see p.133 “Image Repeat Separation Line”.

- 1** Select the size of the copy paper and the reproduction ratio.
- 2** Press [Edit].
- 3** Press [Edit Image].
- 4** Press [Image Repeat].
- 5** Place an original, and then press the [Start] key.



## Centering

You can make copies with the image moved to the center of the paper.

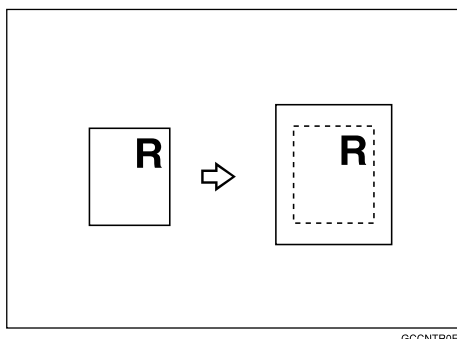

### Note

Original sizes and orientations for centering are shown below.

#### Metric version

Where Original Is Set	Paper Size and Orientation
Exposure glass	A3, B4, A4, 8 <sup>1</sup> / <sub>2</sub> " × 13" <sup>*1</sup>
Document feeder	A3, B4, A4, A5, 11" × 17", 8 <sup>2</sup> / <sub>1</sub> " × 11", 8 <sup>1</sup> / <sub>2</sub> " × 13" <sup>*1</sup>

<sup>\*1</sup> You can select from 8<sup>1</sup>/<sub>2</sub>" × 13", 8<sup>1</sup>/<sub>4</sub>" × 13" and 8" × 13" with the User Tools (System Settings). See "Original: <F/F4> Size Setting", *General Settings Guide*.

#### Inch version

Where Original Is Set	Paper Size and Orientation
Exposure glass	11" × 17", 8 <sup>1</sup> / <sub>2</sub> " × 14", 8 <sup>1</sup> / <sub>2</sub> " × 11"
Document feeder	A4, 11" × 17", 11" × 15", 8 <sup>1</sup> / <sub>2</sub> " × 14", 8 <sup>1</sup> / <sub>2</sub> " × 11", 5 <sup>1</sup> / <sub>2</sub> " × 8 <sup>1</sup> / <sub>2</sub> ", 8 <sup>1</sup> / <sub>2</sub> " × 13" <sup>*1</sup>

<sup>\*1</sup> You can select from 8<sup>1</sup>/<sub>2</sub>" × 13", 8<sup>1</sup>/<sub>4</sub>" × 13" and 8" × 13" with the User Tools (System Settings). See "Original: <F/F4> Size Setting", *General Settings Guide*.

- 1** Select the paper.
- 2** Press [Edit].
- 3** Press [Edit Image].
- 4** Press [Centring].
- 5** Place originals, and then press the [Start] key.

## Covers

Using this function, you can create cover sheets by adding additional pages of different paper or copying existing pages on different paper.

### 📄 Preparation

Before selecting this function, set the tray for the front cover paper. See “Front Cover” or “Back Cover”, *General Settings Guide*.

### 📝 Note

- ❑ When selecting **[Copy]**, select whether the front and back covers are copied one-sided or two-sided. See “Front Cover” or “Back Cover”, *General Settings Guide*.

### 🔍 Reference

You can select the orientation of the back cover, Face up or Face down. See p.131 “Copy Back Cover”.

To place paper when using the interposer, see “Loading Paper in the Interposer”, *General Settings Guide*.

### ❖ Front Cover

The first page of your originals is copied on special cover paper, or a cover sheet is inserted before the first copy.

- Copy

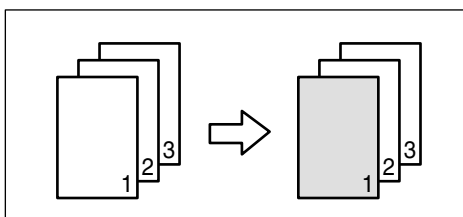

- Blank

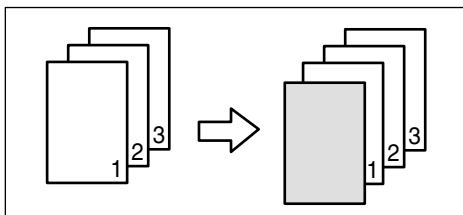

## ❖ Back Covers

The first and last pages of the original are copied on separate paper for cover use.

- Copy

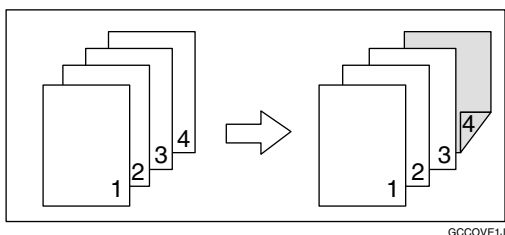

- Blank

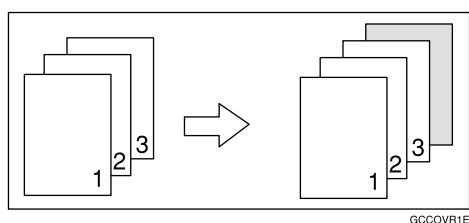

## 🔍 Reference

When you select Front Cover copier mode, you can make a combined copy on the front cover. See p.135 “Front Cover Copy in Combine”.

**1** Press [Cover/Slip Sheet].

**2** Select [Copy] or [Blank] for the front and back cover sheet.

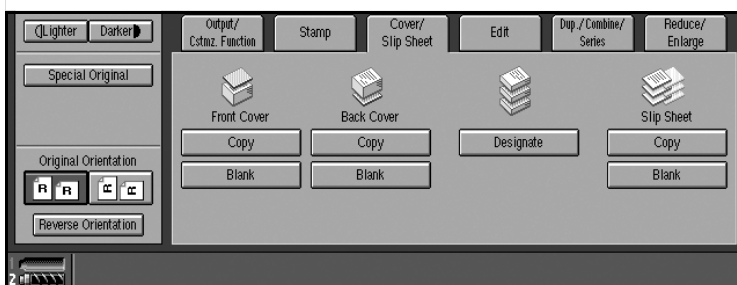

**3** Select the paper tray containing non-cover sheet paper.

**4** Place originals in the ADF, and then press the [Start] key.

## Designate

The following functions are explained in this section:

### ❖ Designate: Copy

Use this function to designate certain pages of your original to be copied onto slip sheets.

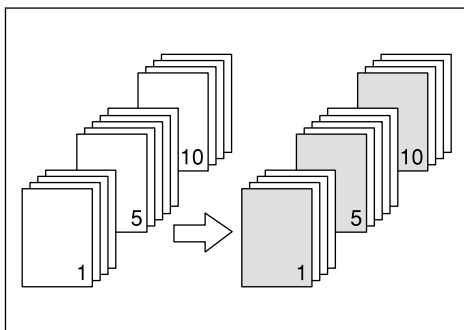

GCCOVR3E

### ❖ Designate: Blank

Use this function to insert the slip sheet into certain pages of your original.

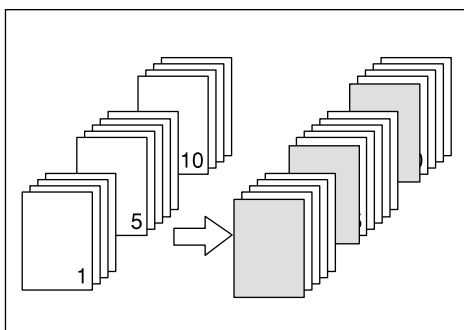

GCCOVR2E

### Note

- When selecting **[Designate : Copy]**, set the same designation sheet as the copy paper in the same orientation.
- You can not select the interposer as the copy paper.
- Except to the tray selecting for copy paper, you can use for designation sheets.
- You can specify up to 100 designate locations.

### Reference

To place paper when using the interposer. See “Loading paper in the Interposer”, *General Settings Guide*.

**1** Press **[Cover/Slip Sheet]**.

**2** Press **[Designate]**.

- 3** Press **[Designate: Copy]** or **[Designate: Blank]**.

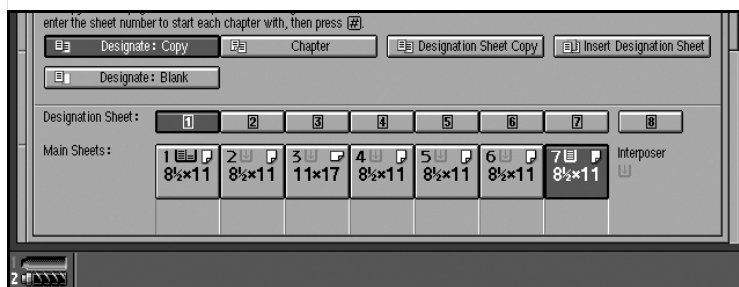

- 4** Select the tray you want to use.
- 5** Enter the number of the originals you want to copy onto slip sheets using the number keys, and then select the tray the slip sheets have been set.
- 6** Press the **[#]** key.
- 7** To specify another page number, repeat steps **5** and **6**.
- 8** Select the tray for the main sheet.
- 9** When all settings have been made, press **[OK]**.
- 10** Place originals, and then press the **[Start]** key.

## Chapters

When using one-sided to two-sided copying, the page locations you specify with this function will appear on the front of copy sheets beginning a new chapter.

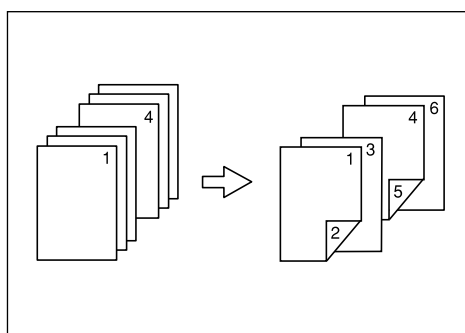

GCSHOW0E

### Preparation

Before selecting this function, press **[Dup./Combine/Series]** and select "1 Sided" for original, and "2 Sided" for copy.

### Note

- You can specify up to 100 chapter locations.
- This function can be combined with the 2 Sided or Combine function.

**1** Press [Cover/Slip Sheet].

**2** Press [Designate].

**3** Press [Chapter].

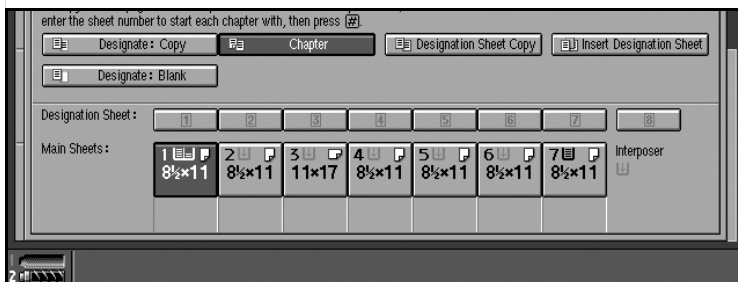

**4** Press the chapter number to set.

**5** Enter the page location of the first page of the first chapter using the number keys, and then press the [#] key.

This display shows example settings.

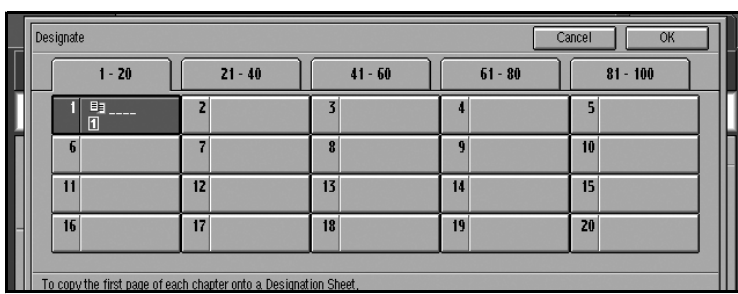

**Note**

- To change the value entered, press the [Clear] key, and then enter the new value.

**6** To specify another page location, repeat step 5.

**7** Select the tray for main sheet.

**8** When you finish specifying the page location, press [OK].

**Note**

- To change the number entered, select the desired item, and then enter the new number.

**9** Place originals, and then press the [Start] key.

## Designation Sheet Copy

You can copy designated pages onto slip sheets.

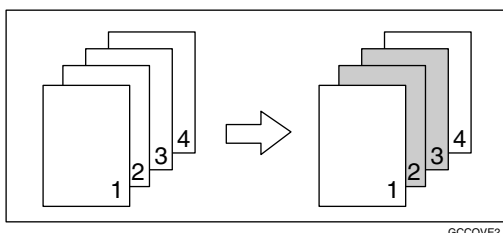

### Note

- When this function is combined with the 2 Sided function, the first page of the designated pages is copied on the front side of a slip sheet.
- You can specify up to 100 locations.

- 1** Press [Cover/Slip Sheet].
- 2** Press [Designate].
- 3** Press [Designation Sheet Copy].

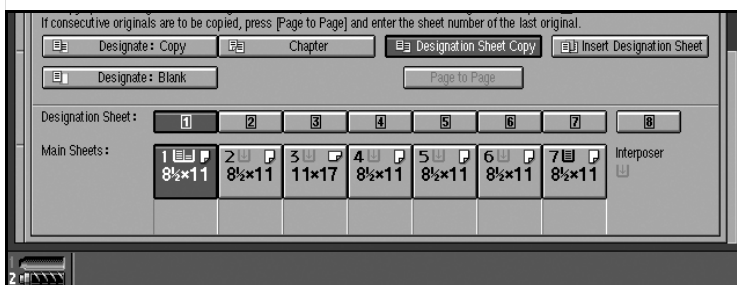

- 4** Enter the sheet number of the originals using the number keys, and then press the [#] key.
- 5** Press [Page to Page].
  - Note**
    - If you do not need to copy consecutive originals, proceed to step **7**.
- 6** Enter the sheet number of the last original using the number keys.
- 7** Select the tray for designate sheet are set, and then press the [#] key.
- 8** To specify another page location, repeat step **4** to **7**.
- 9** Select the tray for main sheets.
- 10** After all settings, press [OK].
- 11** Place originals, and then press the [Start] key.

## Insert Designation Sheet

You can insert a slip sheet before or after the designated page.

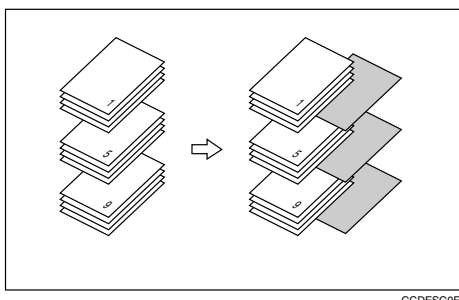

GCDES00E

### Preparation

Before selecting this function, set the tray for slip sheets. See “Paper Tray Settings”, *General Settings Guide*.

### Note

- Set the same slip sheet as the copy paper in the same orientation.
- You can specify up to 100 chapter locations.

### Reference

When you use the interposer, see “Loading Paper in Interposer”, *General Settings Guide*.

- 1** Press [Cover/Slip Sheet].
- 2** Press [Designate].
- 3** Press [Insert Designation Sheet Copy].

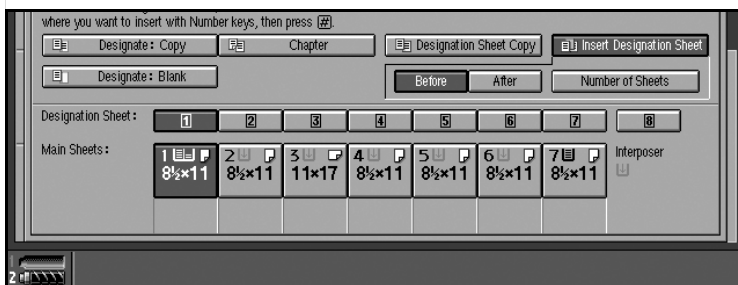

- 4** Press the chapter number you want to select.
- 5** Press [Before] or [After] to select to insert the designation sheet, and then enter the page number using the number key.
- 6** Press [Number of Sheets], and enter the number of the sheets to be inserted using the number key.
- 7** Select the tray for designation sheet.



- 8 Press the **[#]** key.
- 9 You can repeat step 5 to 9 to select where you want to insert it.
- 10 Select the tray for main sheets.
- 11 After finishing all, press **[OK]**.
- 12 Place the originals, and press the **[Start]** key.

## Slip Sheets

Every time an original page changes, a slip sheet is inserted. This function can be used to insert a slip sheet automatically between each OHP transparency copied or used as a stack function. You can also copy onto inserted slip sheets.

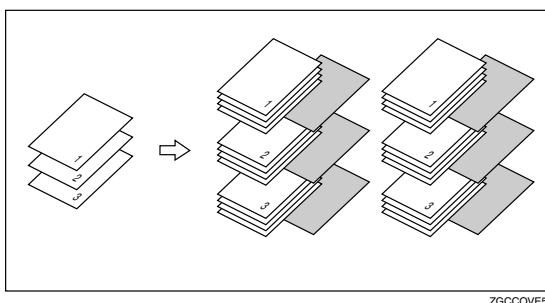

ZGCCOVES

### Preparation

Before selecting this function, specify the paper tray for slip sheets. See “Slip Sheet”, *General Settings Guide*.

If “1 Sided → 2 Sided” is selected, change it to “1 Sided → 1 Sided”.

### Note

- Load slip sheets of the same size, and in the same orientation as the copy paper or OHP transparency.

### ❖ When inserting slip sheets between OHP transparencies

- Copy

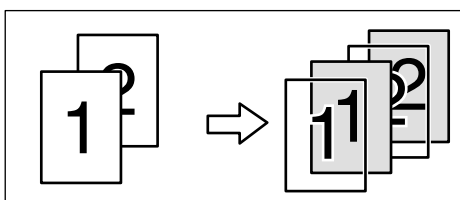

- Blank

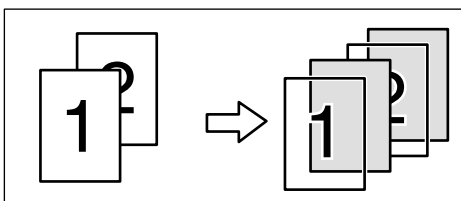

2

**1** Press [Cover/Slip Sheet].

**2** Select [Copy] or [Blank] for the slip sheet.

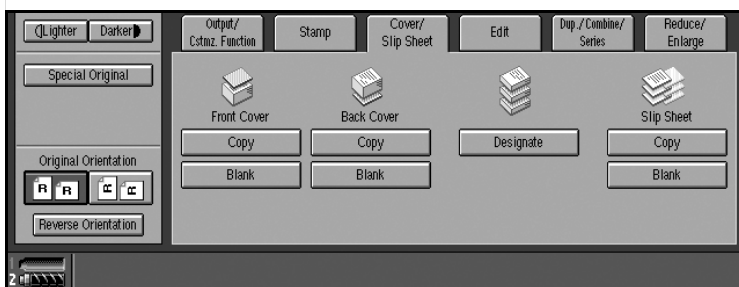

**3** Select the paper tray that contains paper for copying originals.

**4** Place originals, and then press the [Start] key.

## Background Numbering

Use this function to have numbers printed on the background of copies.

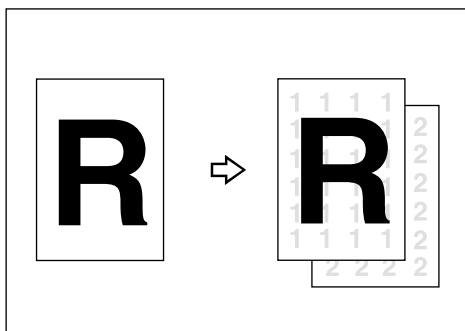

GCSTMP2E

### Reference

You can change settings (e.g., size, density) of the numbers with the User Tools. See p.136 “Background Numbering”.

**1** Press [Stamp].

**2** Check that [Background No.] is selected.

- 3 When you want to start the number another 1, press [Change].
- 4 Enter the number to start counting from using the number keys, and then press the [#] key.

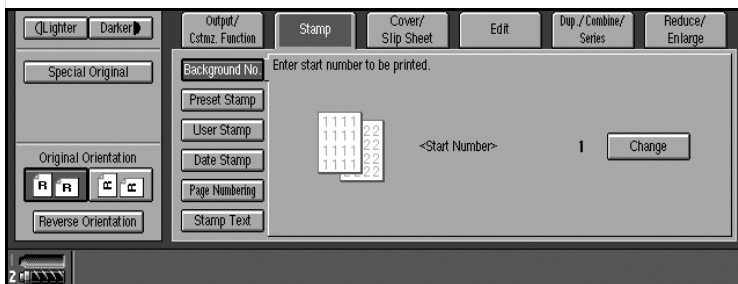

- 5 Place originals, and then press the [Start] key.

## Preset Stamp

Messages you use frequently can be stored in memory and stamped on copies.

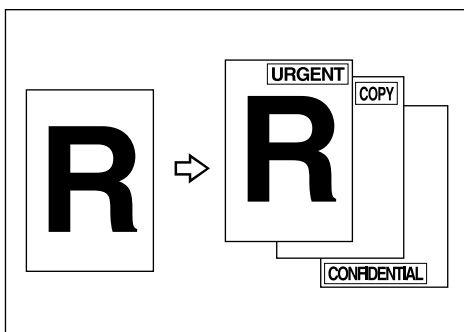

GCSTMP1E

One of the following eight messages can be stamped on copies with a frame around it: "COPY", "URGENT", "PRIORITY", "For Your Info.", "PRELIMINARY", "For Internal Use Only", "CONFIDENTIAL", and "DRAFT".

## Stamp position and original orientation

2

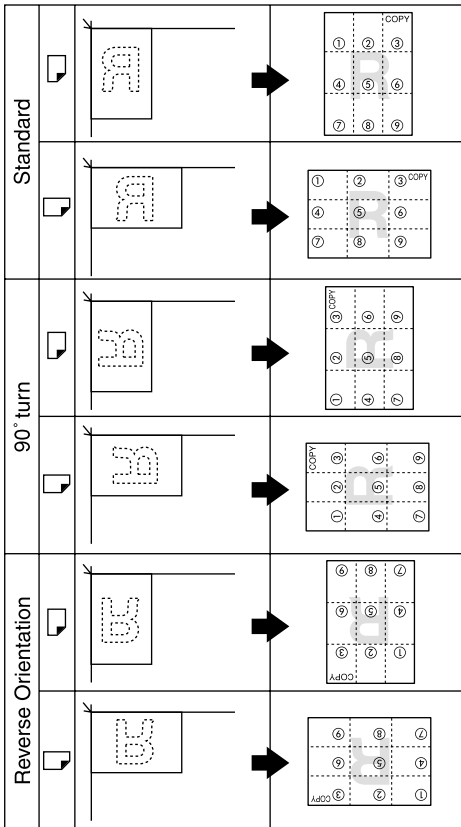

Key on the display	↖	↑	↗	←	✳	→	↙	↓	↘
Stamp position	①	②	③	④	⑤	⑥	⑦	⑧	⑨

GCSTAM5E

**Note**

- ❑ Only one message can be stamped at a time. You can combine a message of the user stamp and that of the preset stamp.

**Reference**

You can change certain Preset Stamp settings (e.g., density) with the User Tools. See p.136 “Preset Stamp”.

You can change the stamp language with the User Tools. See p.136 “Preset Stamp”.

**1** Press [Stamp].

**2** Press [Preset Stamp].

### 3 Select the desired message.



### 4 Press [All Pages] or [1st Page only] to select the print page.

#### Note

- You can change the position, size, and density of the stamp. See p.97 "Changing stamp position, size, and density".

### 5 Place originals, and then press the [Start] key.

## Changing stamp position, size, and density

### 1 Press [Change].

### 2 Select the position for print, size, and density, and then press [OK].

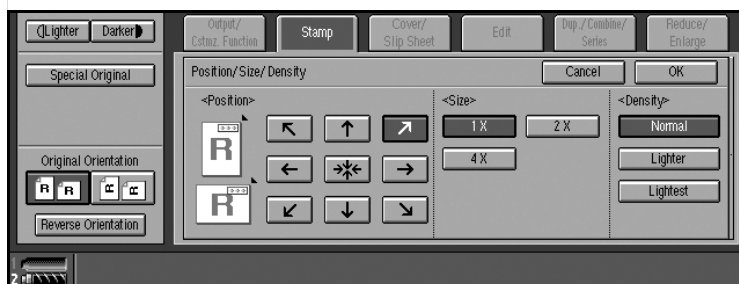

## User Stamp

Copies using the registered stamp.

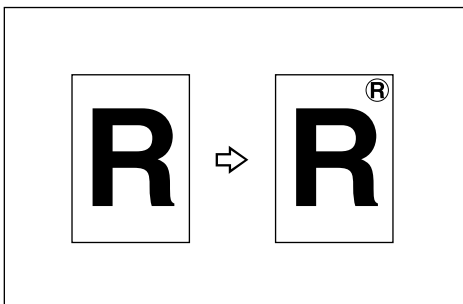

GCSTMP0E



### Preparation

Before using this function, you have to program a user stamp.

See p.99 "To program the user stamp".

### Stamp position and original orientation

Standard		→	
		→	
90° turn		→	
		→	
Reverse Orientation		→	
		→	

Key on the display								
Stamp position	①	②	③	④	⑤	⑥	⑦	⑧

GCSTAM6E

**Note**

- ❑ Only one message can be stamped at a time. You can combine a message of the user stamp and that of the preset stamp.

**Reference**

You can change the stamp position and stamp page. See p.99 "To change the stamp position".

- 1 Press [Stamp].
- 2 Press [User Stamp].
- 3 Select the stamp type you require.
- 4 Press [All Pages] or [1st Page only] to select the print page.
- 5 Place originals, and then press the [Start] key.

**To change the stamp position**

- 1 Press [Change].
- 2 Select the desired position, and then press [OK].

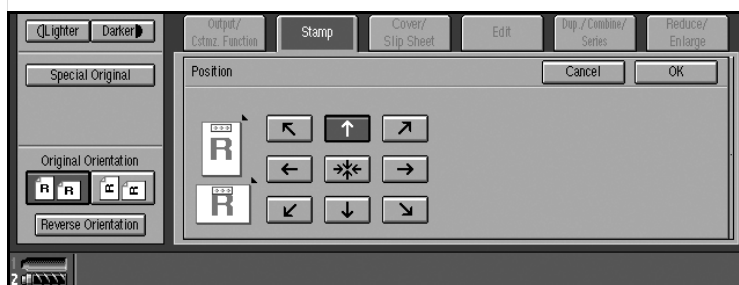
**To program the user stamp****Note**

- ❑ Maximum User Stamp area: 100 mm × 200 mm (3.9" × 7.8")

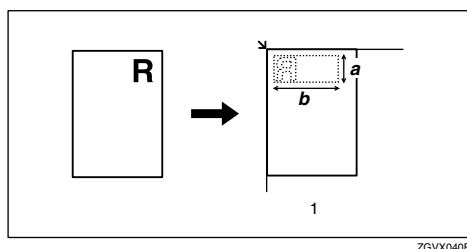

ZGVX040E

**1. Placing the original on the exposure glass**

a: 10 – 297 mm (0.4" – 11.7")  
b: 10 – 432 mm (0.4" – 17")

- ❑ Up to five frequently used messages can be stored in memory.

**1** Make sure the machine is in Copy mode.

**2** Press the **[User Tools]** key.

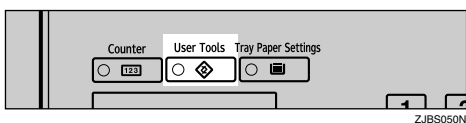

**3** Press **[Copier/Document Server Features]**.

The main menu of the Copier/Document Server Features appears.

**4** Press **[Stamp]**.

**5** Press **[User Stamp]**.

**6** Press **[Program/Delete Stamp]**.

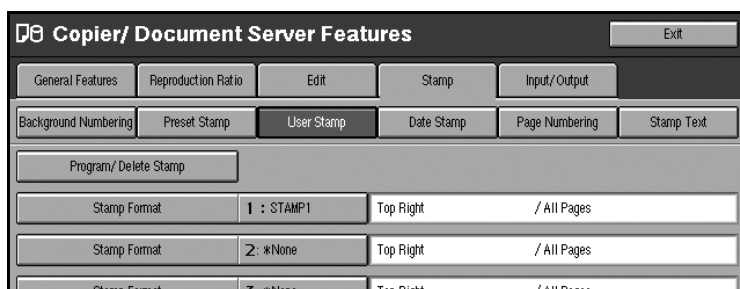

**7** Press **[Program]**, and then press the stamp number (1–5) you want to program.

#### Note

- Stamp numbers with already have settings made for them.
- If the stamp number is already being used, the machine will ask you if you want to overwrite it — press **[Yes]** or **[No]**.

**8** Enter the user stamp name using the letter keys on the control panel. You can register up to 10 characters.

#### Reference

“Entering Text”, *General Settings Guide*.

**9** Enter the horizontal size of the stamp (up to 17 inches) using the number keys, and then press **[#]**.

**10** Enter the vertical size (up to 11.7 inches) in the same way as step **9**.

**11** Place the user stamp on the exposure glass, and then press **[Start Scanning]**.  
The original will be scanned, and the stamp will be registered.

#### Note

- Originals cannot be scanned from the ADF when programming the user stamp.

**12** Press **[Exit]**.



---

## To delete the user stamp

---

### Important

You cannot restore a deleted stamp.

**1** Make sure the machine is in Copy mode.

**2** Press the **[User Tools]** key.

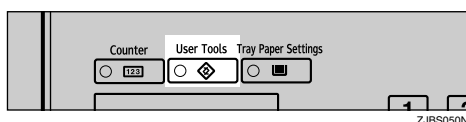

**3** Press **[Copier/Document Server Features]**.

**4** Press **[Stamp]**.

**5** Press **[User Stamp]**.

**6** Press **[Program/Delete Stamp]**.

**7** Press **[Delete]**, and then press the number of the stamp (1–5) you want to delete.

A confirmation message appears.

**8** Press **[Yes]**.

**9** Press **[Exit]**.

The display returns to the main menu of the Copier/Document Server Features.

---

## Date Stamp

---

Use this function to print a date on copies.

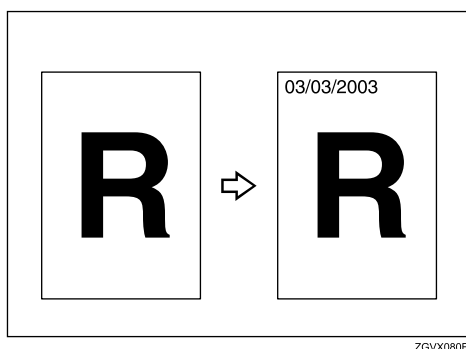

You can select from the following date formats:

- MM/DD/YYYY
- MM.DD.YYYY
- DD/MM/YYYY
- DD.MM.YYYY

2

**Stamp position and original orientation**

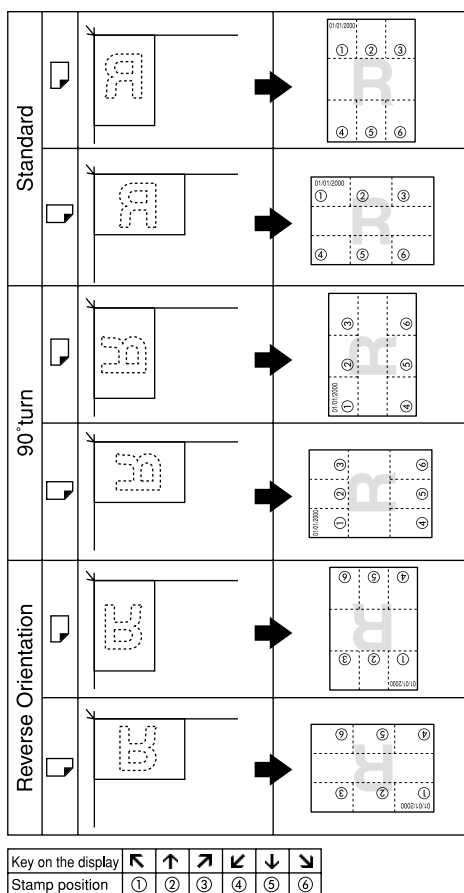

**Reference**

Select the stamp format with the User Tools. See p.137 “Stamp Format”.

You can change the font of the date stamp. See p.137 “Stamp Font”.

You can change the stamp size. See p.137 “Stamp Size”.

When the date is stamped on the dark images, you can superimpose the date stamp. See p.137 “Superimpose”.

**1** Press [Stamp].

**2** Press [Date Stamp].

**3** Press [All Pages] or [1st Page only] to select the print page.

 **Note**

- You can change the font and position of the Date Stamp. See p.103 “To change the date format”.

**4** Place originals, and then press the **[Start]** key.

---

### To change the date format

---

**1** Press [Change Format].

**2** Select the desired date format, and then press [OK].

---

### To change the stamp position

---

**1** Press [Change].

**2** Select the desired Date Stamp position, and then press [OK].

---

## Page Numbering

---

Use this function to print page numbers on your copies.

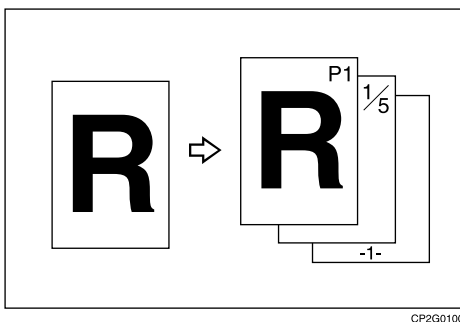

There are six types of Page Numbering (“n” is the total number of original pages):

- P1,P2,...Pn
- 1/n,2/n,...n/n
- -1-,-2-,...-n-
- P.1,P.2,...P.n
- 1, 2...n
- 1-1,1-2,..1-n

 **Note**

- You can select whether the page numbering printed negative where it overlaps black parts of the negative. See p.137 “Page Numbering”.

## Stamp position and orientation of originals

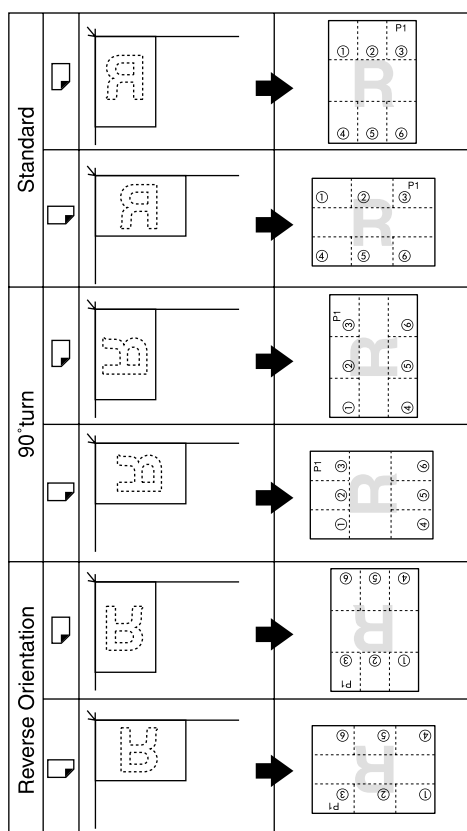

Key on the display	↶	↑	↗	↙	↓	↘
Stamp position	①	②	③	④	⑤	⑥

GCSTAMBE

### Reference

You can set the priority page number format. See p.137 “Stamp Format”.

You can change the font of the stamp. See p.138 “Stamp Font”.

You can change the stamp size. See p.138 “Stamp Size”.

You can set the position of the duplex back page number printed in Duplex mode. See p.138 “Back Side Stamp Position in Duplex”.

You can set how pages are numbered when you use the Combine function and Page Numbering function together. See p.138 “Page Numbering in Combine”.

You can set not to print the page number on slip sheets when you use the Designate function. See p.138 “Stamp on Designated Slip Sheet”.

When you use **[1 Sided Combine]/[2 Sided Combine]**, you can stamp page number per copy paper.

When the page number is stamped on the dark images, you can superimpose the page number. See p.138 “Superimpose”.

You can change the initial settings for stamp position. See p.138 “Stamp Position”.

- 1** Press [Stamp].
- 2** Press [Page Numbering].
- 3** Select the format.



#### Note

- You can specify the stamp position, pages to be stamped, and numbering. See p.105 "Changing the stamp position", and p.105 "Specifying the first printing page and start number".

- 4** Place originals, and then press the [Start] key.

---

### Changing the stamp position

---

- 1** Press the left bottom [Change].
- 2** Select the desired position, and then press [OK].

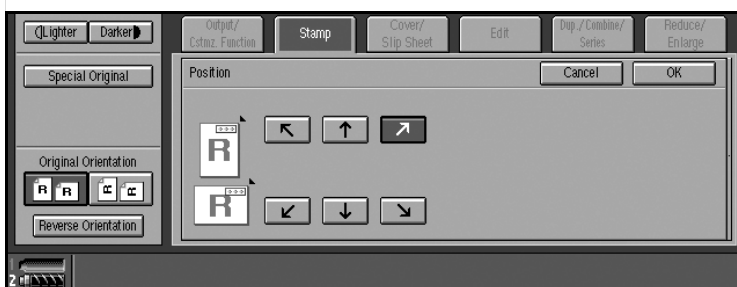

---

### Specifying the first printing page and start number

---

If you selected (P1,P2..., -1-, -2-..., P.1, P.2..., 1, 2..., )

#### Note

- Below gives an example based on when (P1, P2...) is selected. The steps are the same for other cases.

- 1** Press the right bottom [Change].

- 2** Press **[First Page]**, and then enter the original sheet number to start printing from using the number keys.

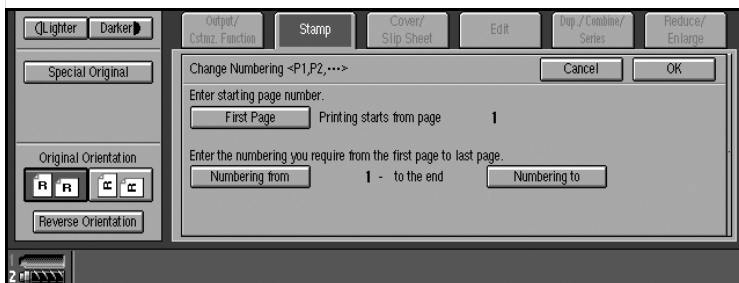

**Note**

- To change the number entered, press **[Clear]**, and then enter a new number.

- 3** Press **[Numbering from]**, and then enter the number to start numbering from using the number keys.

- 4** Press **[Numbering to]**, and then enter the number to end numbering with using the number keys.

**Note**

- If you want to print to the last page, press **[To the End]**.

- 5** Press the **[#]** key.

- 6** When page designation is complete, press **[OK]**.

**Note**

- To change settings after pressing **[OK]**, press the right bottom **[Change]**, and then enter the numbers again.

---

If you selected (1/5, 2/5...)

---

- 1** Press the right bottom **[Change]**.

- 2** Press **[First Page]**, and then enter the original sheet number to start printing from using the number keys.

**Note**

- To change the number entered, press **[Clear]**, and then enter a new number.

- 3** Press **[Numbering from]**, and then enter the page number to start numbering from using the number keys.

- 4** Press **[Numbering to]**, and then enter the number to end numbering with using the number keys.

- 5** Press **[Total Pages]**, and then enter the total number of original pages using the number keys.
- 6** Press the **[#]** key.
- 7** Press **[OK]**.

 **Note**

- To change settings after pressing **[OK]**, press the right bottom **[Change]**, and then enter the numbers again.

---

If you selected (1-1, 1-2,...)

---

- 1** Press the right bottom **[Change]**.
  - 2** Press **[First Page]**, and then enter the original sheet number to start printing from using the number keys.
-  **Note**
- To change the number entered, press **[Clear]**, and then enter a new number.
- 3** Press **[First Chapter No.]**, and then enter the chapter number to start numbering from using the number keys.
  - 4** Press **[Numbering from]**, and then enter the number to start numbering from using the number keys.
  - 5** Press the **[#]** key.
  - 6** If page designation is complete, press **[OK]**.

 **Note**

- To change settings after pressing **[OK]**, press the right bottom **[Change]**, and then enter the numbers again.

## Stamp Text

You can stamp important text on copies up to 64 letters.

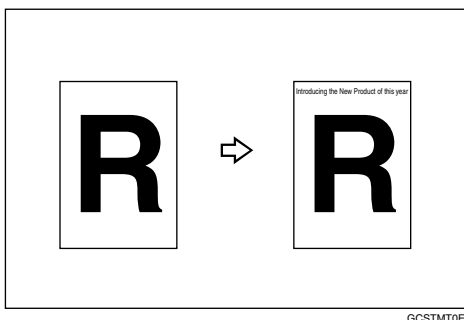

### Note

- If the Main Power is turned off, the text is cleared. To save the typed text, you can register them. See p.112 "Programs".

- 1** Press [Stamp].
- 2** Press [Stamp Text].
- 3** Press [Change Text].
- 4** Enter stamp text, and then press [OK].
- 5** Press [All Pages] or [1st Page only] to select the print page.

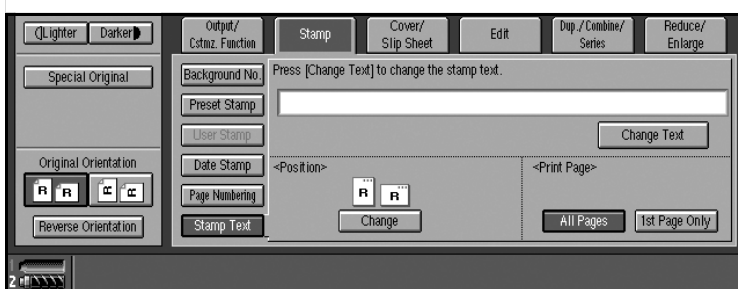

- 6** Place originals, and then press the [Start] key.

### To change the stamp position

- 1** Press [Change].
- 2** Select the desired position, and then press [OK].



## Copy face up

Use this function to reverse the order of copies.

### Reference

If you want copies to be delivered face down when placing originals on the exposure glass, select **[Face down]** for both "Eject Copy Face Up/Down in Glass Mode" of User Tools. See p.139 "Input/Output".

- 1** Press **[Output/Cstmz. Function]**.
- 2** Press **[Reverse Edition Face Up/Down]**.
- 3** Place originals, and then press the **[Start]** key.

## Customize function

You can store the frequently used functions.

### Preparation

You can register the function key which can use often for your convenience. See p.130 "Customize Function: Copy".

- 1** Press **[Output/Cstmz. Function]**.
- 2** Select the function you want to use by pressing the corresponding key.

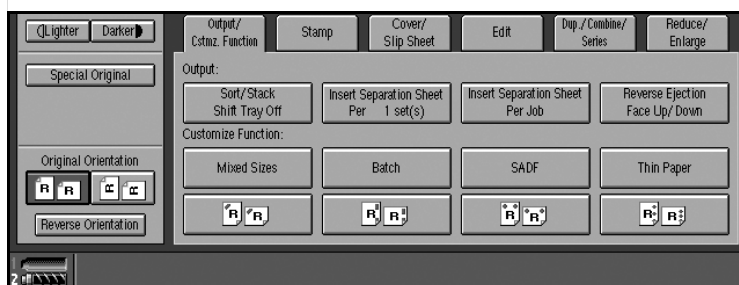

## Storing Originals in the Document Server

The Document Server enables you to save documents in memory and print them as required.

### Important

- ❑ Data stored in the machine might be lost if some kind of failure occurs. The manufacturer shall not be responsible for any damage that might result from loss of data.

### Note

- ❑ Data stored in the Document Server is deleted after 3 days (72 hours), the default setting. You can set stored data to be automatically deleted, or specify a period after which the stored data is automatically deleted. See “Auto Delete File”, *General Settings Guide*.

### Reference

For details about the Document Server, see “Document Server”, *General Settings Guide*.

For information about functions you can use with Document Server, see p.141 “Combination Chart”.

### **1** Press [Store file].

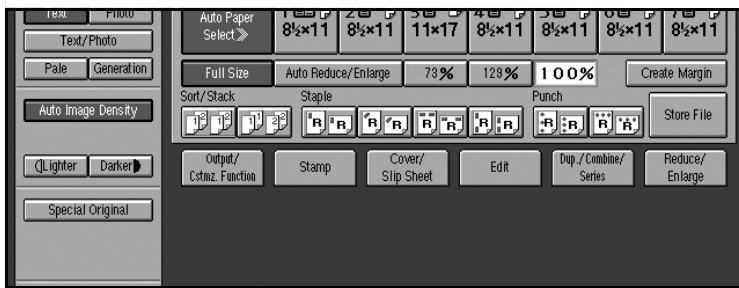

### **2** Enter a file name, user name, or password if necessary.

---

Select the user name registered

---

- 1** Press [User Name].
  - 2** Select the user name, and press [OK].
- 

Entering the user name not registered

---

- 1** Press [User Name].
- 2** Press [Non-programmed Name].
- 3** Enter the new user name using the letter leys, and press OK.

---

## Entering file names

---

- 1 Press **[File Name]**.
- 2 Press **[Delete All]**, and delete the default name.

Note: You can change the file name to use **[Back Space]**.

- 3 Enter the file name, and press **[OK]**.
- 

## Setting password

---

- 1 Press **[Password]**.
- 2 Enter the password using the number keys and press **[OK]**.
- 3 Press **[OK]**.
- 4 Place originals.

### Reference

For more information about types of originals that can be placed and how to place them, see p.10 "Placing Originals".

- 5 Make scanning settings for the original.

- 6 Press the **[Start]** key.

Copies are delivered, and scanned data is stored on the hard disk.

### Note

- To stop scanning, press the **[Stop]** key. To resume a paused scanning job, press **[Yes]** in the confirmation dialog box. To delete saved images and cancel a job, press **[No]**.
- To check a document that has been stored, press the **[Document Server]** key to display the document selection screen.

# Programs

You can store frequently used copy job settings in memory and recall them for future use.

 **Note**

- You can store up to 25 programs.
- You can select standard mode or program No. 25 as the mode to be set when modes are cleared or reset, or immediately after the operation switch is turned on. See p.126 “Change Initial Mode”.
- Paper settings are stored based on size. So, if paper of the same size is set for more than one tray, the paper tray prioritized with User Tools (System Settings) will be selected first. See “Paper Tray Settings”, *General Settings Guide*.
- Programs are not cleared by turning the power off or by pressing the **[Clear Modes]** key. They are canceled only when you delete or overwrite them with another program.

2

## Storing a Program

- 1** Edit the copy settings.
- 2** Press the **[Program]** key.

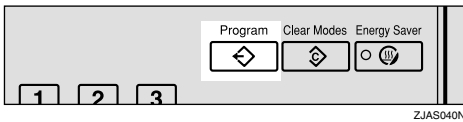

- 3** Press **[Register]**.

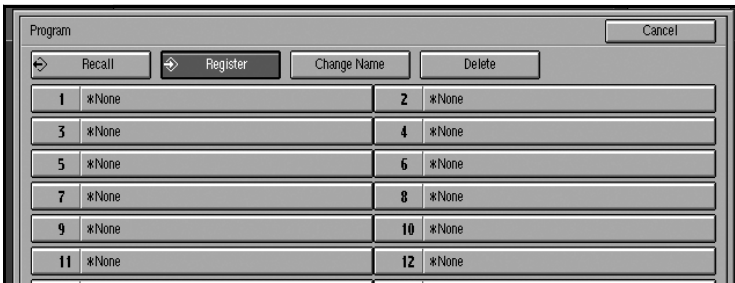

- 4** Press the program number you want to store.

 **Note**

- Program numbers with  against them already have settings made for them.

 **Reference**

p.113 “Changing a stored program”

**5** Enter the program name using the letter keys on the display panel.

You can enter up to 40 characters.

 **Reference**

For details about entering characters, see “Entering Text”, *General Settings Guide*.

 **Note**

If you do not want to enter the program name, proceed to step **6**.

**6** Press [OK].

When the settings are successfully stored, the  indicator before the program number goes on, followed by the program name. The screen returns to the initial copy display after a short time.

---

## Changing a stored program

---

**1** Check the program settings. **Reference**

When you want to check the contents of a program, recall the program. See p.114 “Recalling a Program”.

**2** Repeat steps **1** to **4** of “Storing a Program”.**3** Press [Register].

Repeat steps **5** and **6** of “Storing a Program”.

 **Note**

This overwrites the previous program.

---

## Deleting a Program

---

- 1** Press the **[Program]** key.
- 2** Press **[Delete]**.
- 3** Press the number of the program you want to delete.
- 4** Press **[Yes]** in the confirmation dialog box.

The program is deleted, and the screen returns to the initial copy display.

---

## Recalling a Program

---

- 1** Press the **[Program]** key.
- 2** Press **[Recall]**.
- 3** Press the number of the program you want to recall.

Stored settings are displayed.

 **Note**

- Only programs with  against them contain a program.

# 3. Troubleshooting

## If Your Machine Does Not Operate as You Want

### When a Message is Displayed

The following chart contains explanations of common messages. If other messages appear, follow the instructions as they are displayed.

Message	Causes	Solutions
Cannot detect original size.	The size of the originals placed is difficult to detect. See p.9 "Sizes difficult to detect".	Place the original on the exposure glass. See p.13 "Placing Originals on the Exposure Glass".
		If the original size is difficult to detect, select the size manually.
	Do not use Auto Reduce/Enlarge mode.	
Original is not placed.	Place originals.	
Check original orientation.	There is no copy paper in the same orientation as the originals.	Place the original in the same orientation as the copy paper.
Check paper size.	Incorrect paper size is set.	If you press the <b>[Start]</b> key, copy onto the selected paper will start.
It is over stapling capacity.	The number of sheets per set is over the staple capacity.	Check the stapler capacity. See p.46 "Staple".
Cannot staple paper of this size.	The Staple function cannot be used with the paper size selected.	Select a paper size that can be used in Staple mode. See p.46 "Staple".
Maximum number of sets is □□.	The number of copies exceeds the maximum copy quantity.	You can change the maximum copy quantity. See p.126 "Max. Number of Sets".
Cannot copy. Original is being scanned by other functions.	The Document Server or Scanner function is in use.	To cancel the job in process, press <b>[Exit]</b> , and then press the <b>[Document Server]</b> or <b>[Scanner]</b> key. Next, press the <b>[Stop]</b> key. When the message " <b>[Stop]</b> was pressed. Stop storing?" appears, press <b>[Stop]</b> .

## If You Cannot Make Clear Copies

3

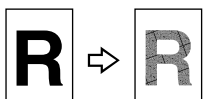
Problem	Causes	Solutions
Copies appear dirty.	The image density is too dark.	Adjust the image density. See p.31 "Adjusting Copy Image Density".
	Auto Image Density is not selected.	Select Auto Image Density.
The reverse side of an original image is copied.	The image density is too dark.	Adjust the image density. See p.31 "Adjusting Copy Image Density".
	Auto Image Density is not selected.	Select Auto Image Density.
A shadow appears on copies when copying pasted originals.	The image density is too dark.	Adjust the image density. See p.31 "Adjusting Copy Image Density".
		Change the orientation of the original.
		Fix mending tape to the pasted part.
The same copy area is dirty whenever making copies.	The exposure glass or the ADF belt is dirty.	Clean them. See "Maintaining Your Machine", <i>General Settings Guide</i> .
Copies are too light.	The image density is too light.	Adjust the image density. See p.31 "Adjusting Copy Image Density".
	Damp or rough grain copy paper is being used.	Use dry paper without a rough grain.
	Toner cartridge is almost empty.	Add toner. See "Replacing Toner", <i>General Settings Guide</i> .
Parts of the image are not copied.	The original is not set correctly.	Place originals correctly. See p.7 "Placing Originals".
	An incorrect paper size is selected.	Select the proper paper size.
Copies are blank.	The original is not set correctly.	Place originals correctly. See p.7 "Placing Originals".
A moiré pattern is produced on copies. 	Original has a dot pattern image or many lines.	Place the original on the exposure glass at a slight angle.



# If You Cannot Make Copies As You Want

This section explains causes and remedies when copy results are not as expected.

## ❖ Basic

Problem	Causes	Solutions
Copies are not stapled.	There are staples jammed in the stapler.	Remove jammed staples. See <i>General Settings Guide</i> .
	The number of copies exceeds the capacity of the stapler.	Check the stapler capacity. See p.145 "Staple".
	Copy paper is curled.	Turn the copy paper over in the tray.
Staples are wrongly positioned.	Originals are not set correctly.	Check the correct position to place the originals. See p.46 "Staple".
You cannot combine several functions.	Selected functions cannot be used together.	Check the combination of functions and make the settings again.  🔍 <b>Reference</b> p.141 "Combination Chart"
Paper frequently jams.	The paper size setting is incorrect.	Set the paper size correctly. See "Paper Tray Settings", <i>General Settings Guide</i> .  Check that the side fences and back fence are set in the paper tray.
Originals jam.	Different size originals are placed in the ADF.	Set the Mixed 1&2 Sided function. See p.71 "Mix 1 & 2 Sided".

## ❖ Edit

Problem	Causes	Solutions
In Double Copies mode, parts of the original image are not copied.	The combination of original and copy paper is not correct.	Select A3 (11" × 17") for A4 (8½" × 11") originals and A4 (8½" × 11") for A5 (5½" × 8½") originals.
In Border, Center, or Center/Border mode, parts of the original image are not copied.	You set a wide erased margin.	Make the margin width narrower. You can adjust it between 2–99 mm (0.1"–3.9"). See p.132 "Erase Border Width" and p.132 "Erase Center Width".
	Originals are not scanned correctly.	Place the originals correctly.

Problem	Causes	Solutions
In Margin Adjustment mode, parts of the original image are not copied.	You set a wide erased margin.	Set a narrower margin with User Tools. You can set the width between 0–30 mm (0"–1.2"). See p.131 "Front Page Margin : Left/Right", p.132 "Front Side Margin : Top/Bottom", p.131 "Back Side Margins : Left/Right", and p.132 "Back Side Margin : Top/Bottom".
	There is a lack of margin space on the opposite side of the binding position.	
In Image Repeat mode, the original image is not copied repeatedly.	You selected copy paper the same size as the originals, or you did not select the proper reproduction ratio.	Select copy paper larger than the originals.
		Select the proper reproduction ratio.

◆ **Combine**

Problem	Causes	Solutions
You cannot make a book from Booklet or Magazine mode by folding copies.	You selected a setting ("Open to left" or "Open to right") that does not match the orientation of originals.	Change the setting.
When using Combine, parts of the image are not copied.	You specified a reproduction ratio that does not match the sizes of your originals and copy paper.	When you specify a reproduction ratio using Manual Paper Select mode, make sure that the ratio matches your originals and the copy paper.   <b>Note</b> <input type="checkbox"/> Select the correct reproduction ratio before using Combine mode.
Copies are not in correct order.	You placed the originals in the incorrect order.	When placing a stack of originals in the ADF, the last page should be on the bottom.
		If you are placing originals on the exposure glass, start with the first page to be copied.

## ❖ Duplex

Problem	Causes	Solutions
Copies are not in correct order.	You placed the originals in the incorrect order.	When placing a stack of originals in the ADF, the last page should be on the bottom.
		If you are placing originals on the exposure glass, start with the first page to be copied.
When using 1 Sided Combine or 2 Sided Combine, copy is made Top to Bottom even though From Left to Right is selected.	The orientation of the originals is incorrect.	Place the originals in the correct orientation. See p.10 "Original Orientation" .

## ❖ Stamp

Problem	Causes	Solutions
The stamp position is wrong.	The paper orientation is wrong.	Check the paper orientation and stamp position.
Nothing is stamped.	The stamp size is larger than the paper size.	Set the stamp size appropriately.
The stamp text in back side copy is not stamped in Duplex mode.	The back side stamp position is incorrect with the paper size.	Reset the back side stamp position. See p.138 "Back Side Stamp Position in Duplex".

## When Memory Is Full

Message	Causes	Solutions & Reference
<p>Memory is full. ## originals have been scanned.</p> <p>Press <b>[Print]</b> to copy scanned originals.</p> <p>Do not remove remaining originals.</p> <p> <b>Note</b></p> <p><input type="checkbox"/> Copying will stop and this message will be displayed when memory is full.</p>	The scanned original exceeds the number of pages that can be stored in memory.	Press <b>[Output]</b> to copy scanned originals and clear the scanning data. Press <b>[Print Inquiry List]</b> to clear the scanning data and not copy.
<p>Press <b>[Continue]</b> to continue printing.</p> <p><b>[Stop] [Continue]</b></p>	The machine checks if the remaining original should be copied, after the scanned original has been printed.	To continue copying, remove all copies, then press <b>[Continue]</b> . To stop copying, press <b>[Stop]</b> .



# 4. User Tools (Copier/Document Server Features)

## User Tools Menu (Copier/Document Server Features)

User tools item names	Default
<b>General Features - General</b> (see p.126 "General Features - General")	
Auto Paper Select Priority	On
Auto Image Density Priority	Text: On Text/Photo: On Photo: Off Pale: On Generation Copy: On
Original Type Priority	Text
Duplex Mode Priority	1 Sided → 2 Sided
Original Orientation in Duplex Mode	Top to Top
Copy Orientation in Duplex Mode	Top to Top
Change Initial Mode	Standard
Reverse Job Mode	Reset
Max. Number of Sets	9999 Sheets
Manual Original Counter Reset	On
Auto Tray Switching	With image rotation
<b>General Features - Image Adjustment</b> (see p.128 "General Features - Image Adjustment")	
Text	Copy Quality: Normal/Image Density: Normal
Text/Photo	Copy Quality: Normal/Image Density: Normal
Photo	Copy Quality: Normal/Image Density: Normal
Pale	Copy Quality: Normal/Image Density: Normal
Generation Copy	Copy Quality: Normal/Image Density: Normal
Dark Background	Off
<b>General Features - Display/Tone</b> (see p.129 "General Features - Display/Tone")	
Original Type Display	Display
Special Original Display	Hide

User tools item names	Default
Paper Display	Display
Panel Features Default	Off
Image Adjustment Priority	Off
Tone: Original Remains	On
Job End Call	On
Customize Function: Copy	
Customize Function: Store Document Server	
Customize Function: Print Document Server	
Special Original Display Defaults	
<b>Reproduction Ratio</b> (see p.131 "Reproduction Ratio")	
Preset Reduce/Enlarge	
Preset Reduce/Enlarge Priority	73%
Shortcut R/E	Metric version <ul style="list-style-type: none"> <li>• Shortcut R/E 1: 71%</li> <li>• Shortcut R/E 2: 122%</li> </ul> Inch version <ul style="list-style-type: none"> <li>• Shortcut R/E 1: 73%</li> <li>• Shortcut R/E 2: 129%</li> </ul>
Create Margin Ratio	93%
<b>Edit</b> (see p.131 "Edit")	
Copy Back Cover	Outside
Front Page Margin: Left/Right	Metric version: Left 5 mm Inch version: Left 0.2 inch
Back Side Margin: Left/Right	Metric version: Right 5 mm Inch version: Right 0.2 inch
Front Side Margin: Top/Bottom	Metric version: Top/Bottom 0 mm Inch version: Top/Bottom 0 inch
Back Side Margin: Top/Bottom	Metric version: Top/Bottom 0 mm Inch version: Top/Bottom 0 inch
1 → 2 Sided Auto Back Side Margin: T to T	Metric version: Right 5 mm Inch version: Right 0.2 inch

User tools item names		Default
1 → 2 Sided Auto Back Side Margin: T to B		Metric version: Top/Bottom 0 mm Inch version: Top/Bottom 0 inch
Erase Border Width		Metric version: 10 mm Inch version: 0.4 inch
Erase Original Shadow in Combine		On
Erase Center Width		Metric version: 10 mm Inch version: 0.4 inch
Image Repeat Separation Line		None
Double Copies Separation Line		None
Separation Line in Combine		None
Copy Order in Combine		From left to right
Orientation: Booklet, Magazine		Open to left
Front Cover Copy in Combine		Combine
Copy on Designating Page in Combine		Combine
Double Copies Position		Same Position
<b>Stamp</b> (see p.136 "Stamp")		
Background Numbering	Size	Normal
	Density	Normal
Preset Stamp	Stamp Language	English
	Stamp Priority	Copy
	Stamp Format (COPY/URGENT/PRIORI- TY/For Your Info./PRELIM- INARY/For Internal Use Only)	Top Right/1×/Normal/All pages
User Stamp	Program/Delete Stamp	
	Stamp Format : 1-5	Top Right/All pages
Date Stamp	Stamp Format	MM/DD/YYYY
	Stamp Font	Font 1
	Stamp Position	Top Left
	Page Numbering in Combine	All pages
	Stamp Size	Auto
	Superimpose	Off

User tools item names		Default
Page Numbering	Stamp Format	P1, P2...
	Stamp Font	Font 1
	Stamp Size	Auto
	Back Side Stamp Position in Duplex	Opposite position to Front
	Page Numbering in Combine	Per original
	Stamp on Designated Sheet Sheet	Off
	Superimpose	Off
	Stamp Position: P1, P2...	Top Right
	Stamp Position: 1/5, 2/5...	Top Right
	Stamp Position: -1-, -2-...	Bottom Center
	Stamp Position: P.1, P.2...	Top Right
	Stamp Position: 1, 2...	Top Right
Stamp Position: 1-1, 1-2...	Bottom Center	
Stamp Text	Stamp Font	Font 1
	Stamp Position	Top Right
	Page Numbering in Combine	All Pages
	Stamp Size	Auto
	Superimpose	Off
<b>Input/Output</b> (see p.139 "Input/Output")		
SADF Auto Reset		5 seconds
Eject Copy Face Up/Down in Glass Mode		Face up
Auto Sort		Off
Memory Full Auto Scan Restart		Off
Sort/Stack Shift Tray Setting		On
Insert Separation Sheet		Per 1 set(s)
Select Staple Position	Finisher 3000B (100-sheet staples)	Top Left/Top Left slant/Top2/Left2
	Booklet Finisher	Top Left/Saddle stich/Top2/Left2
Select Punch Type		3 Holes
Letterhead Setting		Off



# Accessing User Tools (Copier/Document Server Features)

This section is for key operators in charge of this machine. You can change defaults.

## Note

- Settings with the user tools are completely different function from the ordinary copier function. Be sure to return to the copier function when you finish the settings.
- Selected keys are highlighted.
- Any changes you make with User Tools remain in effect even if the main power switch or operation switch is turned off, or the **[Clear Modes]** key is pressed.

## Reference

For details about system settings, see “User Tools”, *General Settings Guide*.

### 1 Press the **[User Tools]** key.

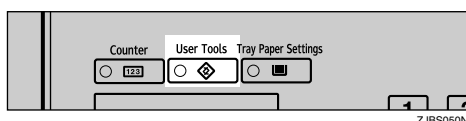

## Note

- When the access code is set, the access code input screen is displayed when changing the initial settings. Enter the registered access code. For details about the access code, see “Key Operator Tools”, *General Settings Guide*.

### 2 Press **[Copier/Document Server Features]**.

### 3 Select the item you want to set.

Setting screens for the selected item is displayed.

## Reference

p.121 “User Tools Menu (Copier/Document Server Features)”

### 4 Change the settings by following the instructions on the display panel, and then press **[OK]**.

---

## Exiting User Tools

---

### 1 After changing User Tools settings, press **[Exit]** on the User Tools main menu.

User Tool changes are complete, and the machine is ready to copy.

## Note

- You can also exit User Tools by pressing the **[User Tools]** key.

# Settings You Can Change with User Tools

---

## General Features - General

---

### ❖ **Auto Paper Select Priority**

You can select to have “Auto Paper Select” selected when the machine is turned on or reset, or when modes are cleared. See p.33 “Selecting Copy Paper”.

### ❖ **Auto Image Density Priority**

You can turn the Auto Image Density on or off for each original type (Text, Text/Photo, Photo, Pale, Generation Copy, and Dark Background).

### ❖ **Original Type Priority**

You can select the type of originals effective when the machine is turned on or reset, or when modes are cleared.

### ❖ **Duplex Mode Priority**

You can select the type of Duplex function effective when the machine is turned on or reset, or when modes are cleared.

### ❖ **Original Orientation in Duplex Mode**

You can set original orientation when making two-sided copies.

### ❖ **Copy Orientation in Duplex Mode**

You can set copy orientation when making two-sided copies.

### ❖ **Change Initial Mode**

You can select the initial mode or Program No. 25 as the mode effective when the machine is turned on or reset, or when modes are cleared.

### ❖ **Reverse Job Mode**

You can select the display when you press the **[New Job]** key or **[New Job]**, keeping the previous one displayed or resetting the display.

### ❖ **Max. Number of Sets**

The maximum copy quantity can be set between 1 and 9999.

### ❖ **Manual Original Counter Reset**

You can select whether to turn the Manual Original Counter display on or off. The Original Counter can be reset by touching this key.

## ❖ Auto Tray Switching

If you load paper of the same size and type in two or more trays, the machine automatically shifts to the other tray when the tray in use runs out (when Auto Paper Select is selected.) This function is called “Auto Tray Switching”. This setting specifies whether to use “Auto Tray Switching” or not.

### Note

[With image rotation] Use this to copy with Auto Tray Switching.

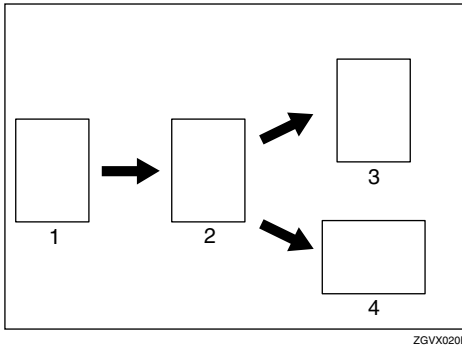

1. Original

2. Paper (Tray 1)

3. Paper (Another tray)

4. Paper (Another tray)

[Without image rotation] Only copies with Auto Tray Switching if you load paper of the same size and in the same orientation in two or more trays. If the paper is not the same size or in the same orientation, copying is interrupted and the message “Load paper.” appears.

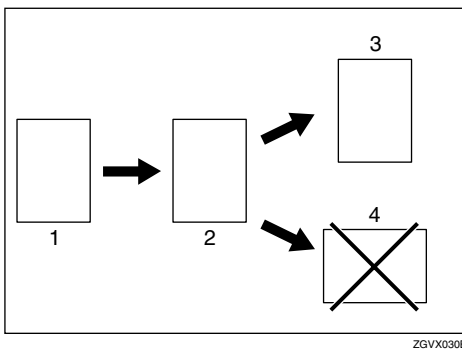

1. Original

2. Paper (Tray 1)

3. Paper (Another tray)

4. Paper (Another tray)

[OFF] When a paper tray runs out, copying is interrupted and the message “Load paper.” appears.

## General Features - Image Adjustment

---

You can select the copy quality and image density for each original type (Text, Text/Photo, Photo, Pale, Generation Copy, and Dark Background).

### ❖ Text

- Copy Quality  
You can select the sharpness of text.
- Image Density  
You can select one of three original image density levels.

### ❖ Text/Photo

- Copy Quality  
When there are photo(s) and text on the original, you can determine which takes priority.
- Image Density  
You can select one of three original image density levels.

### ❖ Photo

- Copy Quality  
For a photo original, you can adjust the finish quality level to match the photo original.
- Image Density  
You can select one of three original image density levels.

### ❖ Pale

- Copy Quality  
You can select the quality level for a pale original.
- Image Density  
You can select one of three original image density levels.

### ❖ Generation Copy

- Copy Quality  
You can select a quality level that will not thicken the lines of the finished image.
- Image Density  
You can select one of three original image density levels.

### ❖ Dark Background

You can select to display **[Dark Background]** on the initial display. Keep the Original Type Display to set to **[Hide]**. See p.129 “Original Type Display”.

## General Features - Display/Tone

### ❖ Original Type Display

You can have original types shown on the initial display.

#### Note

If you select “Hide”, the display is shown as below.

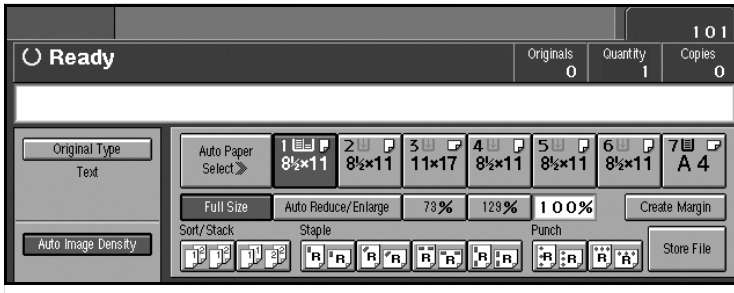

### ❖ Special Original Display

You can have the special original types shown on the initial display.

#### Note

If you select “Hide”, the display is shown as below.



### ❖ Paper Display

You can select to have available paper trays and sizes shown on the initial display.

#### Note

If you select “Hide”, the display is shown as below.

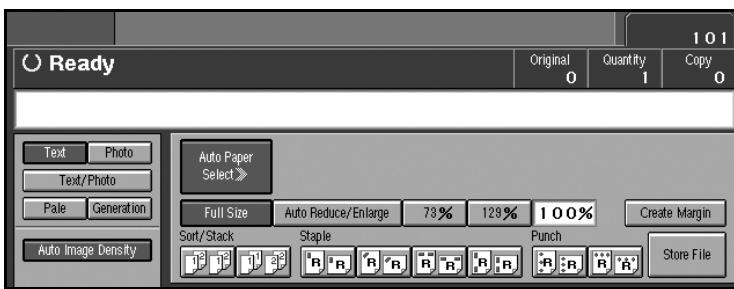

**❖ Panel Features Default**

You can specify the other tab function that is selected automatically just after the machine is turned on or when modes are cleared.

**❖ Image Adjustment Priority**

You can select the function that is priority detected in Image Adjustment mode.

**❖ Tone: Original Remains**

The beeper (key tone) sounds when you forget to remove originals from the exposure glass after copying.

** Note**

If the “Panel Tone” in User Tools (System Settings) is “Off”, the beeper does not sound irrespective of the “Tone: Original Remains” setting. See “Panel Tone”, *General Settings Guide*.

**❖ Job End Call**

You can select to have the beeper sound when copying is complete.

** Note**

If the “Panel Tone” in User Tools (System Settings) is “On”, the machine beeps to notify you if it did not complete a job, for reasons such as: copying was interrupted, the paper tray ran out of paper or a paper jam occurred.

**❖ Customize Function: Copy**

You can register frequently used functions for copying in function keys. You can also change registered functions.

**❖ Customize Function: Store Document Server**

You can register frequently used functions for storing data in the Document Server in function keys. You can also change registered functions.

**❖ Customize Function: Print Document Server**

You can register frequently used functions for printing data stored in the Document Server in function keys. You can also change registered functions.

**❖ Special Original Display Defaults**

You can have special originals shown on the initial display.

---

## Reproduction Ratio

---

### ❖ Preset Reduce/Enlarge

You can set the Reduce/Enlarge ratios first displayed.

### ❖ Preset Reduce/Enlarge Priority

You can select a Reduce/Enlarge ratio that is detected as priority in preset Reduce/Enlarge mode.

### ❖ Shortcut R/E

You can register up to two frequently used Reduce/Enlarge ratios other than the fixed Reduce/Enlarge ratio and have them shown on the initial display. You can also change registered Reduce/Enlarge ratios.

### ❖ Create Margin Ratio

You can set a Reduce/Enlarge ratio when registering “Create Margin” in a shortcut key.

#### Note

- You can enter a ratio between 90 and 99 (in increments of 1%) using the number keys.

---

## Edit

---

### ❖ Copy Back Cover

When copying the back cover, you can specify to have the back cover outside (outside page) or inside (inside page).

### ❖ Front Page Margin : Left/Right

You can specify left and right margins on the front side of copies in Margin Adjust mode.

#### Note

- You can enter a margin width of between 0 and 30 mm in 1 mm increments (0 inch and 1.2 inch in 0.1 inch steps) using the number keys.

### ❖ Back Side Margins : Left/Right

You can specify left and right margins on the back side of copies in Margin Adjust mode.

#### Note

- You can enter a margin width of between 0 and 30 mm in 1 mm increments (0 inch and 1.2 inch in 0.1 inch increments) using the number keys.

**❖ Front Side Margin : Top/Bottom**

You can specify top and bottom margins on the front side of copies in Margin Adjust mode.

** Note**

- You can enter a margin depth of between 0 and 30 mm in 1 mm increments (0 inch and 1.2 inch in 0.1 inch increments) using the number keys.

**❖ Back Side Margin : Top/Bottom**

You can specify top and bottom margins on the back side of copies in Margin Adjust mode.

** Note**

- You can enter a margin depth of between 0 and 30 mm in 1 mm increments (0" and 1.2" in 0.1" increments) using the number keys.

**❖ 1→2 sided Auto Back Side Margins:T to T**

In 1 sided → 2 sided Duplex mode, you can specify the margins on the back side.

** Note**

- You can enter a margin width of between 0 and 30 mm in 1 mm increments (0" and 1.2" in 0.1" increments) using the number keys.

**❖ 1→2 sided Auto Back Side Margins :T to B**

In 1 sided → 2 sided Duplex mode, you can specify the margins on the back side.

** Note**

- You can enter a margins depth of between 0 and 30 mm in 1 mm increments (0 inch and 1.2 inch in 0.1 inch increments) using the number keys.

**❖ Erase Border Width**

Specify the width of erased border margins using this function.

** Note**

- You can enter a width of between 2 and 99 mm in 1 mm increments (0.1 inch and 3.9 inch in 0.1 inch increments) using the number keys.

**❖ Erase Original Shadow in Combine**

In Combine Copy mode, you can erase a 3 mm (0.1 inch) boundary margin around all four edges of originals.

**❖ Erase Center Width**

You can specify the width of the erased center area using this function.

** Note**

- You can enter a width of between 2 and 99 mm in 1 mm increments (0.1 inch and 3.9 inch in 0.1 inch increments) using the number keys.



**❖ Image Repeat Separation Line**

You can select a separation line in Image Repeat mode.

- None



- Solid



- Broken A



- Broken B



- Crop Marks

** Note**

- An image of approximately 1.5 mm (0.06 inch) will not be copied as the width of the separation line, when specifying solid or broken lines.

**❖ Double Copies Separation Line**

You can select a separation line in Double Copy mode.

- None



- Solid



- Broken A



- Broken B



- Crop Marks



 **Note**

- An image of approximately 1.5 mm (0.06 inch) will not be copied as the width of the separation line, when specifying solid or broken lines.

❖ **Separation Line in Combine**

You can select a separation line in Combine mode. See p.56 “1 Sided Combine”, and p.60 “2 Sided Combine”.

- None



- Solid



- Broken A



- Broken B



- Crop Marks



 **Note**

- An image of approximately 1.5 mm (0.06 inch) will not be copied as the width of the separation line, when specifying solid or broken lines.

### ❖ Copy Order in Combine

You can set the copy order in Combine mode to “Left to Right” or “Top to Bottom”.

Top to Top		Top to Bottom	
From Left to Right	From Right to Left	From Left to Right	From Right to Left
Front            Back	Front            Back	Front            Back	Front            Back
Front            Back	Front            Back	Front            Back	Front            Back

GCCOMB100E

### ❖ Orientation: Booklet, Magazine

You can select the type of originals for Booklet or Magazine mode.

### ❖ Front Cover Copy in Combine

You can make a combined copy on the front cover sheet when you select Front Cover copier mode.

Combine	Do not Combined

GCST019E

### ❖ Copy on Designating Page in Combine

You can make a combined copy on a designated page.

### ❖ Double Copies Position

You can select copy position of the bottom or left page relative to the top or right page as the original image position. This setting is available when Centering/Cornering is selected in the Document Server.

---

## Stamp

---

---

### Background Numbering

---

❖ **Size**

You can set the size of the numbers.

❖ **Density**

You can set the density of the numbers.

---

### Preset Stamp

---

❖ **Stamp Language**

You can select the language of the message that is printed in Stamp mode.

❖ **Stamp Priority**

You can select the priority stamp type when [**Preset Stamp**] is pressed. See “Preset Stamp”.

❖ **Stamp Format**

You can adjust the size, density, and print page for the stamp.

- Stamp Position

You can set the position at which the stamp is printed.

Press the arrow keys to adjust the position.

- Stamp Size

You can set the size of the stamp.

- Density

You can set the pattern used to print the stamp.

 **Note**

Normal: The stamp is printed on the image. You cannot confirm which parts overlap the image.

Lighter: The image can be seen through the stamp.

Lightest: You can see the image even clearer than in the “Lighter” setting.

- Page Stamp

You can have the stamp printed on the first or all pages.

---

## User Stamp

---

### ❖ Program/Delete Stamp

You can register/change/delete the designs you like as user stamps.

#### Note

- You can register up to five custom stamps of your favorite designs. See p.99 “To program the user stamp”.

#### Reference

For how to delete stamps, see p.101 “To delete the user stamp”.

### ❖ Stamp Format

You can adjust the position and print page for registered User Stamps 1 to 5.

- Stamp Position  
Set the position where the stamp is printed.
- Page to Stamp  
Set to have the stamp printed on all or only the first page.

---

## Date Stamp

---

### ❖ Stamp Format

You can select the date format for Date Stamp mode.

### ❖ Stamp Font

You can select the Date Stamp font.

### ❖ Stamp Position

You can set where the stamp is printed.

### ❖ Page to Stamp

You can have the date printed on the first or all pages.

### ❖ Stamp Size

You can set the Date Stamp size.

### ❖ Superimpose

You can have Date Stamp printed as a negative where it overlaps black parts of the image.

---

## Page Numbering

---

### ❖ Stamp Format

You can select the priority page number format when [Page Numbering] is pressed.

❖ **Stamp Font**

You can select the font of the page numbers printed in Page Numbering mode.

❖ **Stamp Size**

You can set the size of the stamp printed in Page Numbering mode.

❖ **Back Side Stamp Position in Duplex**

You can set where the duplex back page number printed in Duplex mode.

❖ **Page Numbering in Combine**

You can set how pages are numbered when you use the Combine function and Page Numbering function together.

❖ **Stamp on Designated Slip Sheet**

You can print the page number on slip sheets when you use the Designate function set to “Copy” and Page Numbering function together.

❖ **Superimpose**

You can have page numbers printed as a negative where they overlap black parts of the image.

❖ **Stamp Position**

P1, P2...Stamp Position: 1/5, 2/5...Stamp Position: -1-, -2-...Stamp Position: P.1, P.2...Stamp Position: 1, 2...Stamp Position: 1-1, 1-2...

You can set where the stamp is printed.

Press the arrow keys to adjust the position.

---

## Stamp Text

---

❖ **Stamp Font**

You can select the font of the text in Stamp Text mode.

❖ **Stamp Position**

You can set the position at which the stamp is printed.  
Press the arrow keys to adjust the position.

❖ **Page to Stamp**

You can set how pages are numbered when you use the Combine function and Stamp Text function together.

❖ **Stamp Size**

You can select the size of the stamp printed in Stamp Text mode.

❖ **Superimpose**

You can have page numbers printed as a negative where they overlap black parts of the image.

---

## Input/Output

---

### ❖ SADF Auto Reset

When you set one original at a time in the ADF, the **Auto Feed** indicator lights for a selected time after an original is fed, showing it is ready for another original.

#### Note

You can adjust this time from 3 seconds to 99, in 1 second increments.

### ❖ Eject Copy Face Up/Down in Glass

You can specify the way copies are delivered when copying an original from the exposure glass.

### ❖ Auto Sort

You can have Sort mode selected when the machine is turned on or reset, or if the mode is cleared.

### ❖ Memory Full Auto Scan Restart

If memory becomes full while scanning, the machine can make copies of those already scanned, and then automatically resume scanning remaining originals.

You can enable or disable this function.

#### Note

If you select **[Off]**:

- When memory becomes full, the machine stops operations allowing you to remove copies delivered to the output tray.

If you select **[On]**:

- You can leave the machine unattended to make all the copies, but resulting pages will not be sequentially ordered.

### ❖ Sort/Stack Shift Tray Setting

You can select to turn Shift Tray Setting on or off in sort or stack mode.

### ❖ Insert Separation Sheet

You can set the number of sets between Separation Sheets.

#### Note

You can set the number from 1 set to 999 sets.

### ❖ Select Staple Position

You can register a frequently-used type of stapling in the top left staple key on the initial display. You can also change the registered type.

### ❖ **Select Punch Type**

You can select the type of punch.

#### **Note**

- The 4-hole punch type can only punch in the 4-hole format.

### ❖ **Letterhead Setting**

If you select “On” in this function, the machine rotates the image to the correct position.

#### **Note**

- Orientation-fixed (top to bottom) or 2-sided paper might not be printed correctly, depending on how the originals and paper are placed.

#### **Reference**

When using letterhead paper, pay attention to the paper orientation. See “Orientation-Fixed Paper or 2-Sided Paper”, *General Settings Guide*.



# 5. Specifications

## Combination Chart

The combination chart given below shows modes that can be used together. When using the chart, note the explanations of the symbols, as given in the following table.

	In the chart without mark means it enable to use together.
●	These modes cannot be used together. The second mode selected will be the mode you work in.
×	These modes cannot be used together. The first mode selected will be the mode you work in.

The following tables show the combinations of functions.

Function	Function selected first	Function selected after
Original Orientation (Standard Orientation)	Original Orientation (Standard Orientation)	Original Orientation (Standard Orientation)
Batch Mode	Batch Mode	Batch Mode
Mixed Sizes	Mixed Sizes	Mixed Sizes
Custom Size Originals	Custom Size Originals	Custom Size Originals
SADF Mode	SADF Mode	SADF Mode
Thin Mode	Thin Mode	Thin Mode
Face Up	Face Up	Face Up
Auto Image Density	Auto Image Density	Auto Image Density
Dark Background	Dark Background	Dark Background
Manual Image Density	Manual Image Density	Manual Image Density
Original Type Setting	Original Type Setting	Original Type Setting
Auto Paper Select	Auto Paper Select	Auto Paper Select
Manual Paper Select	Manual Paper Select	Manual Paper Select
Reduce/Enlarge	Reduce/Enlarge	Reduce/Enlarge
Create Margin	Create Margin	Create Margin
Zoom	Zoom	Zoom
Auto Reduce/Enlarge	Auto Reduce/Enlarge	Auto Reduce/Enlarge
Size Magnification	Size Magnification	Size Magnification
Directional Magnification(%)	Directional Magnification(%)	Directional Magnification(%)
Directional Size Magnification (inch)	Directional Size Magnification (inch)	Directional Size Magnification (inch)
Sort	Sort	Sort
Separation	Separation	Separation
Stack	Stack	Stack
Staple	Staple	Staple
Punch	Punch	Punch
1 Sided - 2 Sided/2 Sided - 2 Sided	1 Sided - 2 Sided/2 Sided - 2 Sided	1 Sided - 2 Sided/2 Sided - 2 Sided
1 Sided Combine	1 Sided Combine	1 Sided Combine
2 Sided Combine	2 Sided Combine	2 Sided Combine
Book - 1 Sided	Book - 1 Sided	Book - 1 Sided
Book - 2 Sided	Book - 2 Sided	Book - 2 Sided
2 Sided - 1 Sided	2 Sided - 1 Sided	2 Sided - 1 Sided
1 Sided - Booklet	1 Sided - Booklet	1 Sided - Booklet
2 Sided - Booklet	2 Sided - Booklet	2 Sided - Booklet
1 Sided - Magazine	1 Sided - Magazine	1 Sided - Magazine
2 Sided - Magazine	2 Sided - Magazine	2 Sided - Magazine
Mix 1 & 2 Sided	Mix 1 & 2 Sided	Mix 1 & 2 Sided
Repeat	Repeat	Repeat
Double Copy	Double Copy	Double Copy
Centering	Centering	Centering
Scanning Position	Scanning Position	Scanning Position
Border Erase	Border Erase	Border Erase
Center Erase	Center Erase	Center Erase
Center/Border Erase	Center/Border Erase	Center/Border Erase
3 Edges Full Bleed	3 Edges Full Bleed	3 Edges Full Bleed
Inside Erase	Inside Erase	Inside Erase
Outside Erase	Outside Erase	Outside Erase
Margin Adjustment	Margin Adjustment	Margin Adjustment
Background Numbering	Background Numbering	Background Numbering
Preset Stamp	Preset Stamp	Preset Stamp
User Stamp	User Stamp	User Stamp
Date Stamp	Date Stamp	Date Stamp
Stamp Text	Stamp Text	Stamp Text
Page Numbering	Page Numbering	Page Numbering
Covers	Covers	Covers
Designate	Designate	Designate
Chapter	Chapter	Chapter
Designation Sheet Copy	Designation Sheet Copy	Designation Sheet Copy
Blank Slip Sheets	Blank Slip Sheets	Blank Slip Sheets
Slip Sheets	Slip Sheets	Slip Sheets
Document Server	Document Server	Document Server

\*1 You cannot use Top 2 and Saddle stitch of Staple position with Standard Punch position. You cannot use Top, Top Slant or Bottom with 90° turn Punch position.

# Supplementary Specifications

❖ **Mixed Size mode**

- Copy and scanning speed may be reduced.

❖ **Multi Bypass Tray Copy**

- The following paper sizes can be selected:  
A3☐, B4☐, A4☐☐, B5☐☐, A5☐☐, 11" × 17"☐, 11" × 15"☐, 10" × 14"☐,  
8<sup>1</sup>/<sub>2</sub>" × 14"☐, 8<sup>1</sup>/<sub>2</sub>" × 13"☐, Letter (8<sup>1</sup>/<sub>2</sub>" × 11")☐☐, 8<sup>1</sup>/<sub>4</sub>" × 13"☐, 5<sup>1</sup>/<sub>2</sub>" ×  
8<sup>1</sup>/<sub>2</sub>"☐☐, 8" × 13"☐, 8" × 10<sup>1</sup>/<sub>2</sub>"☐, 8" × 10"☐, 12" × 18"☐, 7<sup>1</sup>/<sub>4</sub>" ×  
10<sup>1</sup>/<sub>2</sub>"☐☐, 8K☐, 16K☐☐
- You can place copy paper up to the indicated with the limit mark.

❖ **Preset Reduce/Enlarge**

- You can select one of 12 preset ratios (five enlargement ratios, seven reduction ratios).
- You can select a ratio regardless of original size or copy paper. With certain ratios, part of the image might not be copied or margins will appear.
- Copies can be reduced or enlarged as follows:
- **Metric version**

5

Ratio (%)	Original → Copy paper size
400 (enlarge area by 16)	--
200 (enlarge area by 4)	A5→A3, A6→A4, B6→B4
141 (enlarge area by 2)	A4→A3, A5→A4, A6→A5, B5→B4, B6→B5
122	F→A3, A4→B4
115	B4→A3
93	--
82	F→A4, B4→A4
75	B4→F4, B4→F
71 (reduce area by 1/2)	A3→A4, A4→A5
65	A3→F
50 (reduce area by 1/4)	A3→A5, F→A5
25	--

- **Inch version**

Ratio (%)	Original → Copy paper size
400 (enlarge area by 16)	--
200 (enlarge area by 4)	5 <sup>1</sup> / <sub>2</sub> " × 8 <sup>1</sup> / <sub>2</sub> " → 11" × 17"
155 (enlarge area by 2)	5 <sup>1</sup> / <sub>2</sub> " × 8 <sup>1</sup> / <sub>2</sub> " → 8 <sup>1</sup> / <sub>2</sub> " × 14"
129	8 <sup>1</sup> / <sub>2</sub> " × 11" → 11" × 17"
121	8 <sup>1</sup> / <sub>2</sub> " × 14" → 11" × 17"
93	--
85	F → 8 <sup>1</sup> / <sub>2</sub> " × 11"
78	8 <sup>1</sup> / <sub>2</sub> " × 14" → 8 <sup>1</sup> / <sub>2</sub> " × 11"
73	11" × 15" → 8 <sup>1</sup> / <sub>2</sub> " × 11"
65	11" × 17" → 8 <sup>1</sup> / <sub>2</sub> " × 11"
50 (reduce area by 1/4)	11" × 17" → 5 <sup>1</sup> / <sub>2</sub> " × 8 <sup>1</sup> / <sub>2</sub> "
25	--

- ❖ **Zoom**

- Specifiable reproduction ratios are between 25 – 400%.
- You can select a ratio regardless of original size or copy paper. With certain ratios, parts of the image might not be copied or margins will appear.

- ❖ **Auto Reduce/Enlarge**

- Specifiable reproduction ratios are between 25 – 400%.

- ❖ **Size Magnification**

- If the calculated ratio is over maximum or under the minimum ratio, it is automatically adjusted to within available range. However, with certain ratios, parts of the image might not be copied or margins will appear.
- Specifiable reproduction ratios are between 25 – 400%.

- ❖ **Directional Size Magnification**

- Specifiable reproduction ratios are between 25 – 400%.
- When entering a percentage ratio, you can specify any value within the permitted range, regardless of original size or copy paper. However, depending on settings and other conditions, part of the image may not be copied, or margins will appear.
- When entering a size in mm, if the calculated ratio is over maximum or under minimum ratio, it is automatically adjusted to within available range. However, with some ratios, parts of the image might not be copied or margins will appear.

◆ **Sort**

The number of copies that can be placed on the tray is as follows. When the number exceeds capacity, remove copies from the tray.

	Paper size and orientation	Number of copies
Finisher 3000B(100-sheet staples)	<b>Finisher upper tray</b>	
	A4, B5, A5, 8 1/2" × 11", 5 1/2" × 8 1/2"	500 sheets
	A3, B4, 11" × 17", 8 1/2" × 14", 12" × 18"	250 sheets
	<b>Finisher shift tray</b>	
	A4, B5, 8 1/2" × 11"	3,000 sheets
	A3, B4, A4, B5, 11" × 17", 8 1/2" × 14", 8 1/2" × 11", 12" × 18"	1,500 sheets
	A5, 5 1/2" × 8 1/2"	500 sheets
	A5, 5 1/2" × 8 1/2"	100 sheets
Booklet finisher	<b>Finisher upper tray</b>	
	A4, B5, A5, 8 1/2" × 11", 5 1/2" × 8 1/2"	250 sheets
	A3, B4, 11" × 17", 8 1/2" × 14", 12" × 18"	50 sheets
	<b>Finisher shift tray 1</b>	
	A4, B5, A5, 8 1/2" × 11"	500 sheets
	A3, B4, 11" × 17", 8 1/2" × 14", 12" × 18"	250 sheets
	A5, 5 1/2" × 8 1/2"	100 sheets
	<b>Finisher shift tray 2</b>	
	A4, 8 1/2" × 11"	2,500 sheets
	A3, B4, A4, B5, 11" × 17", 8 1/2" × 14", 8 1/2" × 11", 12" × 18"	1,250 sheets
	A5	500 sheets
	A5, 5 1/2" × 8 1/2"	100 sheets

Paper weight is 80 g/m<sup>2</sup> (20 lb).

✎ **Note**

☐ When using Staple function, tray capacity may be reduced.

- Paper sizes and orientations that can be used with the Sort function are A3, B4, A4, B5, A5, 11" × 17", 8 1/2" × 14", 8 1/2" × 11" and 5 1/2" × 8 1/2".

- Paper sizes and orientations that can be used with the Shift Sort function are as follows:

	Paper size and orientation
Finisher 3000B (100-sheet staples)	A3☐, B4☐, A4☐☐, B5☐☐, A5☐☐, 11" × 17"☐, 8 <sup>1</sup> / <sub>2</sub> " × 11"☐☐, 5 <sup>1</sup> / <sub>2</sub> " × 8 <sup>1</sup> / <sub>2</sub> "☐☐, 8 <sup>1</sup> / <sub>2</sub> " × 14"☐, 12" × 18"☐
Booklet finisher	A3☐, B4☐, A4☐☐, B5☐☐, A5☐☐, 11" × 17"☐, 8 <sup>1</sup> / <sub>2</sub> " × 11"☐☐, 5 <sup>1</sup> / <sub>2</sub> " × 8 <sup>1</sup> / <sub>2</sub> "☐☐

### ❖ Stack

- Paper sizes and orientations that can be used with the Stack function are as follows:

	Paper size and orientation
Finisher 3000B (100-sheet staples)	A3☐, B4☐, A4☐☐, B5☐☐, A5☐☐, 11" × 17"☐, 8 <sup>1</sup> / <sub>2</sub> " × 11"☐☐, 5 <sup>1</sup> / <sub>2</sub> " × 8 <sup>1</sup> / <sub>2</sub> "☐☐, 8 <sup>1</sup> / <sub>2</sub> " × 14"☐, 12" × 18"☐
Booklet finisher	A3☐, B4☐, A4☐☐, B5☐☐, A5☐☐, 11" × 17"☐, 8 <sup>1</sup> / <sub>2</sub> " × 11"☐☐, 5 <sup>1</sup> / <sub>2</sub> " × 8 <sup>1</sup> / <sub>2</sub> "☐☐













### ❖ Staple

In the following cases, copies will be delivered to the shift tray without stapling:



















- When the number of sheets for one set is above stapler capacity.
- When memory reaches 0% during copying.
- When using Double copies, or "1 Sided → 1 Sided", "1 Sided → 2 Sided", "2 Sided → 1 Sided" or "2 Sided → 2 Sided" in Combine mode, select ☐ original for ☐ copy and ☐ original for ☐ copy.
- When using Double copies, or "1 Sided 2 Pages → 1 Sided Combine" and "1 Sided 4 Pages → 2 Sided Combine" in Combine mode, select ☐ original for ☐ copy and ☐ original for ☐ copy.
- When using "Left 2" or "Top 2" with Double copies, or "1 Sided → 1 Sided", "1 Sided → 2 Sided", "2 Sided → 1 Sided", or "2 Sided → 2 Sided" in Combine mode, select ☐ original for ☐ copy and ☐ originals for ☐ copy.
- If you use the Auto Paper Select function in Mixed Size mode, the machine selects the proper size of paper and staples it even if you place different sizes of originals. Set the size of paper you want to use in the paper tray beforehand. The sizes of the paper you can staple in Mixed Size mode are as follows:
  - A3☐ and A4 ☐
  - B4 ☐ and B5 ☐
  - 11" × 17"☐ and Letter (8<sup>1</sup>/<sub>2</sub>" × 11")☐

The sizes and orientations of paper you can staple and stapler capacity are as follows.

• **Finisher 3000B (100-sheet staples)**







Paper sizes and orientations	Stapler capacity (sheets)
A4  , B5  , 8 1/2" x 11" 	100
A3  , B4  , 11" x 17"  , 8 1/2" x 14" 	50
In Mixed Size Mode	
A4  / A3  , B5  / B4  , 8 1/2" x 11"  / 11" x 17" 	50

• **Booklet finisher**



Paper sizes and orientation	Stapler capacity (sheets)
A4  , B5  , 8 1/2" x 11" 	50
A3  , B4  , 11" x 17"  , 8 1/2" x 14" 	30
In Mixed Size Mode	
A4  / A3  , B5  / B4  , 8 1/2" x 11"  / 11" x 17" 	30
Saddle stitch	
A3  , B4  , A4  , 11" x 17"  , 8 1/2" x 11" 	15

- When the number of copies exceeds tray capacity, copying stops. If this happens, remove copies from the tray, and then resume copying. The finisher capacities after stapling are as follows.

• **Finisher 3000B (100-sheet staples)**

Paper sizes and orientation	Number of the sheets	Number of stapled copies (sets)
A4  , B5  , 8 1/2" x 11" 	10-100 sheets	200-30
	2-9 sheets	150
A3  , B4  , 11" x 17"  , 8 1/2" x 14" 	10-50 sheets	150-30
	2-9 sheets	150

• **Booklet finisher**

Paper sizes and orientation	Maximum number of sheets	Maximum number of the stapled copies (sets)
<b>Finisher Shift Tray 1</b>		
A4  , 8 1/2" x 11" 	10-50 sheets	50-10
	2-9 sheets	50
Other paper size	10-30 sheets	25-16
	2-9 sheets	25











Paper sizes and orientation		Maximum number of sheets	Maximum number of the stapled copies (sets)
In the Mixed Size Mode		2-30 sheets	16
<b>Finisher Shift Tray 2</b>			
A4 ☐, 8 1/2" × 11" ☐		10-50 sheets	250-50
		2-9 sheets	250
A4 ☐, B5 ☐ ☐, 8 1/2" × 11" ☐		10-50 sheets	125-25
		2-9 sheets	125
Other paper size		10-30 sheets	125-40
		2-9 sheets	125
In the Mixed Size Mode		2-30 sheets	50
Saddle stitch	A4 ☐, 8 1/2" × 11" ☐	2-5 sheets	25
		6-10 sheets	15
		11-15 sheets	10
	Other paper size	2-5 sheets	30
		6-10 sheets	20
		11-15 sheets	10

- You cannot change stapling positions during copying.
- When the original image is rotated, stapling position turns by 90 degrees.
- When **[Top]** or **[Bottom]** is selected and paper with the same orientation as the original is not loaded, the image is rotated and paper of the same size and different orientation is selected.
- With certain stapling settings, you cannot use the Rotate function.
- When **[Saddle Stitch]** is selected, copies are stapled using the saddle stitch stapler, folded in half and then delivered.
- When **[Saddle Stitch]** is selected with the Magazine function, copies are stapled using the saddle stitch stapler, folded like a magazine and then delivered.











#### ❖ Punch

- With certain Punch function settings, the Rotate function cannot be used.
- Since punch holes are made in each copy, positions vary slightly.
- Punchable paper sizes are as follows:

• **Booklet Finisher**

Punch unit type			
2 & 4 holes type	2 holes		A3–A5, 11" × 17"–5 <sup>1</sup> / <sub>2</sub> " × 8 <sup>1</sup> / <sub>2</sub> "
			A4–A5, 8 <sup>1</sup> / <sub>2</sub> " × 11", 5 <sup>1</sup> / <sub>2</sub> " × 8 <sup>1</sup> / <sub>2</sub> "
	4 holes		A3, B4, 11" × 17"
			A4, B5, 8 <sup>1</sup> / <sub>2</sub> " × 11"
4 holes type	4 holes		A3–A5, 11" × 17"–5 <sup>1</sup> / <sub>2</sub> " × 8 <sup>1</sup> / <sub>2</sub> "
			A4–A5, 8 <sup>1</sup> / <sub>2</sub> " × 11", 5 <sup>1</sup> / <sub>2</sub> " × 8 <sup>1</sup> / <sub>2</sub> "
2 & 3 holes type	2 holes		A3–A5, 11" × 17"–5 <sup>1</sup> / <sub>2</sub> " × 8 <sup>1</sup> / <sub>2</sub> "
			A4–A5, 8 <sup>1</sup> / <sub>2</sub> " × 11", 5 <sup>1</sup> / <sub>2</sub> " × 8 <sup>1</sup> / <sub>2</sub> "
	3 holes		A3, B4, 11" × 17"
			A4, B5, 8 <sup>1</sup> / <sub>2</sub> " × 11"

• **Finisher 3000B (100–sheet staples)**

Punch unit type			
2 holes type(metric version) 4 holes type(metric version) 2 & 4 holes type(metric version)	2 holes		A3–A5, 11" × 17"–5 <sup>1</sup> / <sub>2</sub> " × 8 <sup>1</sup> / <sub>2</sub> "
			A4–A5, 8 <sup>1</sup> / <sub>2</sub> " × 11", 5 <sup>1</sup> / <sub>2</sub> " × 8 <sup>1</sup> / <sub>2</sub> "
	4 holes		A3, 11" × 17"
			A4, 8 <sup>1</sup> / <sub>2</sub> " × 11"
4 holes type(narrow 2×2 version)	4 holes		A3–B5, 11" × 17"–8 <sup>1</sup> / <sub>2</sub> " × 11"
			A4–A5, 8 <sup>1</sup> / <sub>2</sub> " × 11", 5 <sup>1</sup> / <sub>2</sub> " × 8 <sup>1</sup> / <sub>2</sub> "
2 holes type(inch version) 3 holes type(inch version) 2 & 3 holes type(inch version)	2 holes		A3–A5, 11" × 17"–5 <sup>1</sup> / <sub>2</sub> " × 8 <sup>1</sup> / <sub>2</sub> "
			A4–A5, 8 <sup>1</sup> / <sub>2</sub> " × 11", 5 <sup>1</sup> / <sub>2</sub> " × 8 <sup>1</sup> / <sub>2</sub> "
	3 holes		A3, B4, 11" × 17"
			A4, B5, 8 <sup>1</sup> / <sub>2</sub> " × 11"

❖ **Duplex**

- When an odd number of originals is placed in the ADF, the back of the last page is blank.
- During copying in Mixed 1 & 2 Sided mode, the image is shifted to allow for the binding margin. Image quality on the front and back of copies may differ.

❖ **Combine**

- If the calculated ratio is under the minimum ratio, it is automatically adjusted to within available range. However, with certain ratios, parts of the image might not be copied.
- You cannot use custom size paper.



- In this mode, the machine automatically selects the ratio. This ratio depends on copy paper size and the number of originals.
- Specifiable reproduction ratios are between 25 – 400%.
- If the orientation of originals is different from that of the copy paper, the machine will automatically rotate the image by 90 degrees to make copies properly.
- If the number of originals placed is less than the number specified for combining, the last page is left blank, as shown in the illustration.

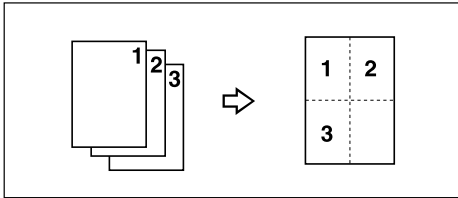

### ❖ Copying Book Originals

- The machine sets the reproduction ratio automatically to fit paper size and copies originals together onto the paper.
- The machine uses ratios in the range of 25 to 400%
- If the calculated ratio is under the available minimum, it will be adjusted to minimum ratio. However, with certain ratios, parts of the image might not be copied.
- Even if the orientation of originals is different from that of the copy paper, the machine will automatically rotate the image by 90 degrees to make copies properly.
- If you mix originals of different sizes or place originals in different orientations, you cannot use this function.
- Four originals are copied onto each sheet of copy paper with this function. If the number of originals scanned is less than a multiple of four, the last page will be blank.
- Copying to make a magazine may take some time after scanning originals.
- If the booklet finisher is installed and you select **[Magazine]** and **[Staple (Saddle Stitch)]**, copies are stacked, stapled at the center, folded in half, and then delivered.

❖ **Repeat**

Depending on paper size, ratio, and orientation, parts of repeated images may not be copied.

- If you use this function with “Custom Size Original”, you can make multiple copies of an image section by specifying the image area's vertical and horizontal length from the base point. In this case, place your original on the exposure glass. See p.18 “Placing custom size originals”.

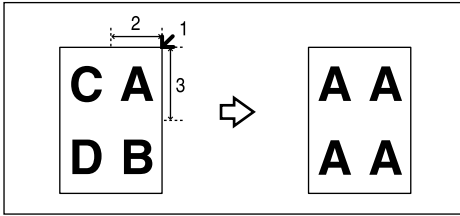

1. Base point

2. Horizontal length

3. Vertical length

❖ **Centering**

Although the original is set at a different orientation to the paper, the machine will not rotate the image by 90 degrees (Rotate copy).

❖ **Erase**

The width of the erased margin varies depending on the reproduction ratio. If the size of the original is different to sizes listed in the following chart, the erased margin might be shifted.

• **Metric version**

Where original is set	Paper size and orientation
Exposure glass	A3☐, B4☐, A4☐☐, B5☐☐, A5☐, 8 <sup>1</sup> / <sub>2</sub> " × 14"☐, 8 <sup>1</sup> / <sub>2</sub> " × 13"☐
ADF	A3☐, B4☐, A4☐☐, B5☐☐, A5☐☐, 8 <sup>1</sup> / <sub>2</sub> " × 13"☐

• **Inch version**

Where original is set	Paper size and orientation
Exposure glass	11" × 17"☐, 8 <sup>1</sup> / <sub>2</sub> " × 14"☐, 8 <sup>1</sup> / <sub>2</sub> " × 11"☐☐, 10" × 14"☐, 8" × 10"☐
ADF	11" × 17"☐, 8 <sup>1</sup> / <sub>2</sub> " × 14"☐, 8 <sup>1</sup> / <sub>2</sub> " × 11"☐☐, 10" × 14"☐, 5 <sup>1</sup> / <sub>2</sub> " × 8 <sup>1</sup> / <sub>2</sub> "☐

You can erase two parts using “Erase Inside 1” with “Erase Inside 2”.

### ❖ Margin Adjustment

If you set a binding margin too wide, part of the image may not be copied. When making copies in Combine mode, the binding margin is added to copies after the combination is finished.

### ❖ Preset Stamp

- You can change the size and density of the stamp with User Tools. Depending on paper size, if you change the stamp size, part of the stamp may not be printed.
- When you use this function with the Magazine or Booklet function, you can print the stamp only on the first page.

### ❖ Date Stamp

- When using Combine mode, the date stamp is printed as follows:

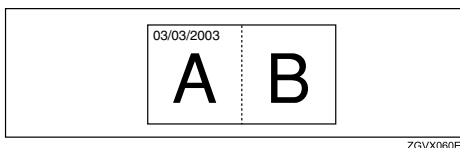

- When using the Magazine or Booklet function, the date stamp is printed as follows:

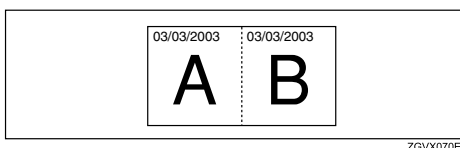

### ❖ Page Numbering

When page numbering is used with Combine mode, page numbers are printed as follows:

- Page Numbering per original:  
Combined with 1 Sided/2 Sided in the Combine function

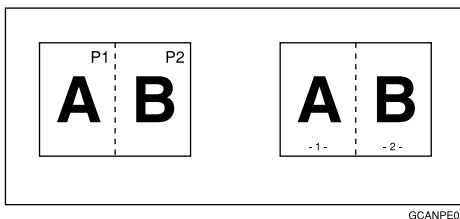

Combined with the Magazine or Booklet function

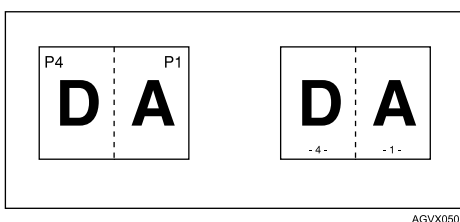

- Page Numbering per copy:  
Combined with 1 Sided/2 Sided in the Combine function

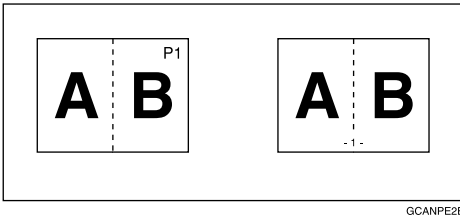

GCANPE2E

If you combine this function with the Duplex (Top to Top) function and select the “P1, P2” or “1/n, 2/n” format, page numbers on the back are printed as follows:

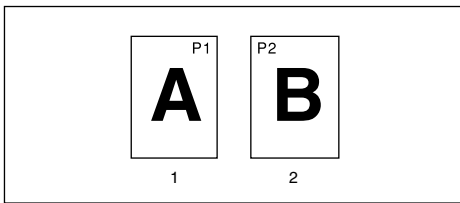

GCSTMPBE

5

### 1. Front

### 2. Back

#### ❖ Front Cover, Front/Back Cover

- In “Cover Sheet Tray” of User Tools (System Settings), if you selected **[On Mode Select]** for **[Display Setting]**, the machine refers to the settings in “Cover Sheet Tray” to ascertain whether the front and back covers are copied one-sided or two-sided. If you selected **[Always Display]** for **[Display Setting]**, the machine refers to the settings in “Paper Type” to ascertain whether the front and back covers are copied one-sided or two-sided. See “Paper Tray Settings” “Paper Type” and “Cover Sheet Tray”, *General Settings Guide*.
- If Blank mode is selected, the cover is not counted as a copy.

#### ❖ Designate

- When **[Combine (1 Sided→2 Sided)]** has been selected, specified pages will always be copied on the front of copies, as in Chapters mode.
- In “Cover Sheet Tray” of User Tools (System Settings), if you selected **[On Mode Select]** for **[Display Setting]**, the machine refers to the settings in “Cover Sheet Tray” to ascertain whether the front and back covers are copied one-sided or two-sided. If you selected **[Always Display]** for **[Display Setting]**, the machine refers to the settings in “Paper Type” to ascertain whether the front and back covers are copied one-sided or two-sided. See “Paper Tray Settings” “Paper Type” and “Cover Sheet Tray”, *General Settings Guide*.
- If Blank mode is selected, the designate sheet is not counted as a copy.

## ❖ Slip Sheets

When not copying onto slip sheets, the sheets are not counted as copies.

- In “(Cover Sheet Tray)” of Tray Paper Settings, if you selected **[On Mode Select]** for **[Display Setting]**, the machine refers to the settings in “Cover Sheet Tray” to ascertain whether the front and back covers are copied one-sided or two-sided. If you selected **[Always Display]** for **[Display Setting]**, the machine refers to the settings in “Paper Type” to ascertain whether the front and back covers are copied one-sided or two-sided. See “Paper Tray Settings” “Paper Type” and “Cover Sheet Tray”, *General Settings Guide*.
- Tab stock are possible to use as slip sheets.

# INDEX

---

- 1 sided → 2 sided, 53
- 1 sided combine
  - 1 sided 2 pages → combine 1 side, 56
  - 1 sided 4 pages → combine 1 side, 56
  - 1 sided 8 pages → combine 1 side, 57
  - 2 sided 1 page → combine 1 side, 57
  - 2 sided 2 pages → combine 1 side, 57
  - 2 sided 4 pages → combine 1 side, 58
- 2 sided → 2 sided, 53
- 2 sided combine
  - 1 sided 16 pages → combine 2 side, 60
  - 1 sided 4 Pages → combine 2 side, 60
  - 1 sided 8 pages → combine 2 side, 60
  - 2 sided 16 pages → combine 2 side, 61
  - 2 sided 4 pages → combine 2 side, 61
  - 2 sided 8 pages → combine 2 side, 61

## A

---

- Adjusting
  - copy image density, 31
- Auto
  - image density, 31
  - paper select, 33
  - paper select priority, 121
  - reduce/enlarge, 37, 143
  - start, 21
  - tray switching, 127
- Auto paper select, 34
- Auto Reduce/Enlarge, 143

## B

---

- Basic procedure, 19
- Batch mode, 15
- Booklet Finisher, 148
- Booklet finisher, 146
- Book originals, copying, 65
- Border erase, 76
- Bypass tray, 27

## C

---

- Center/border erase, 77
- Centering, 150
- Change
  - date format, 103
  - stamp position, 99, 103
- Changing
  - number of sets, 44
  - stamp density, 97
  - stamp position, 105
  - stamp position, size and density, 97
  - stamp size, 97
  - stored program, 113
- Chapters, 89
- Clear key, 5
- Clear Modes/Energy Saver key, 4
- Combination chart, 141
- Combine, 148
- Combined auto and manual image density, 31
- Control Panel, 4
- Copier/document server features, 121
- Copy functions, 31
  - 1 sided combine, 56
  - 2 sided combine, 60
  - adjusting copy image density, 31
  - auto reduce/enlarge, 37
  - centering, 85
  - covers, 86
  - date stamp, 101
  - directional magnification (%), 40
  - directional magnification (inch), 41
  - double copies, 82
  - duplex, 53
  - image repeat, 83
  - margin adjustment, 74
  - page numbering, 103
  - preset reduce/enlarge, 35
  - preset stamp, 95
  - selecting copy paper, 33
  - selecting original type setting, 32
  - series copies, 63
  - size magnification, 39
  - slip sheets, 93
  - sort, 42
  - stack, 46
  - Staple, 46
  - user stamp, 98
  - zoom, 36

Copying, 19  
    *auto start*, 21  
    *Book Originals*, 149  
    *interrupt copy*, 21  
    *job preset*, 22  
    *Left original beeper*, 22  
Copying Book Originals, 149  
Copying from the bypass tray  
    *onto custom size paper*, 29  
    *onto special paper*, 30  
    *onto standard size paper*, 29  
Copying from the multi bypass tray (Tray 7)  
    *onto custom size paper*, 27  
Covers  
    *Front*, 86  
    *front/back*, 87  
Create margin mode, 36

## D

---

Date stamp, 137, 151  
    *change position*, 103  
    *change style*, 103  
    *font*, 138  
    *position*, 138  
    *position and original orientation*, 102  
    *size*, 138  
    *stamp format*, 137  
    *superimpose*, 138  
Deleting  
    *program*, 114  
    *user stamp*, 101  
Designate, 152  
Directional Size Magnification, 143  
Display Panel, 5  
Document server, 110  
Duplex, 148

## E

---

Edit, 122, 131  
    1→2 sided auto back side margins – T to B, 132  
    1→2 sided auto back side margins – T to T, 132  
    *back side margin – left/right*, 131  
    *back side margin – top/bottom*, 132  
    *copy order in combine*, 135  
    *double copies separation line*, 133  
    *erase border width*, 132  
    *erase center width*, 132  
    *erase original shadow in combine*, 132  
    *front cover copy in combine*, 135  
    *front page margin – left/right*, 131  
    *front side margin – top/bottom*, 132  
    *image repeat separation line*, 133  
    *separation line in combine*, 134  
Erase, 75, 150  
    *border*, 75  
    *border width*, 132  
    *center/border*, 75  
    *center width*, 132  
    *original shadow in combine*, 132  
Exposure glass, 7

## F

---

Finisher 3000B (100-sheet staples), 146, 148  
Finisher 3000B(100-sheet staples), 146  
Font, 137  
Format, 137  
Front Cover, Front/Back Cover, 152

## G

---

- General features, 121, 126
  - auto paper select priority*, 126
  - auto tray switching*, 127
  - change initial mode*, 126
  - copy orientation in duplex mode*, 126
  - duplex mode priority*, 126
  - max. number of sets*, 126
  - original orientation in duplex mode*, 126
  - original type priority*, 126
- Generation, 32

## I

---

- Inch version, 150
- Input/Output, 139
  - auto sort*, 139
  - letterhead setting*, 140
  - memory full auto scan restart*, 139
  - SADF auto reset*, 139
- Interrupt key, 4

## M

---

- Manual image density, 31
- Manual paper select, 34
- Manuals for This Machine, i
- Margin Adjustment, 151
- Messages, 115
- Metric Version, 150
- Mixed Size mode, 142
- Mixed size mode, 16
- Multi Bypass tray copy, 142

## N

---

- Number keys, 5

## O

---

- OHP Transparencies, 25
- Original
  - beeper*, 22
  - combine*, 58
  - copy orientation*, 54
  - orientation*, 10
  - orientation and completed copies*, 55
  - orientation in duplex mode*, 126
  - type priority*, 126
- Originals, 7

## P

---

- Page numbering, 137, 151
  - duplex back page stamping position*, 138
  - first printing page*, 105
  - font*, 138
  - page numbering in combine*, 138
  - position*, 105
  - position and original orientation*, 98
  - size*, 138
  - stamp format*, 137
  - stamp on designated slip sheet*, 138
  - stamp position*, 138
  - start number*, 105
  - superimpose*, 138
- Pale, 32
- Photo, 32
- Placing
  - custom size originals*, 18
  - originals*, 7, 10, 13, 14, 18
  - originals in document feeder*, 14
  - originals on exposure glass*, 13
- Preset Reduce/Enlarge, 142
- Preset stamp, 136, 151
  - changing density*, 97
  - changing position*, 97
  - changing size*, 97
  - format*, 136
  - language*, 136
  - position and original orientation*, 96
  - priority*, 136
- Program key, 5
- Programs, 112
- Punch, 147
- Punching copies, 50

## R

---

- Recalling a program, 114
- Repeat, 150
- Reproduction ratio, 122, 131
  - create margin ratio*, 131
  - shortcut R/E*, 131
- Rotated copy, 34



## S

---

- SADF mode, 16
- Sample copy, 43
- Sample Copy key, 5
- Screen Contrast Knob, 4
- Selecting
  - copy paper*, 33
  - original type setting*, 32
- Size, 137
- Size Magnification, 143
- Slip Sheets, 153
- Sort, 144
- Specifications, 141
- Stack, 46, 145
- Stamp, 136
  - date stamp*, 101
  - format*, 136, 137
  - language*, 136
  - page numbering*, 103
  - position*, 137
  - position and orientation of originals*, 104
  - position and original orientation*, 98, 102
  - preset stamp*, 95
  - priority*, 136
  - setting*, 137
  - user stamp*, 98
- Staple, 145
- Stapling position and original setting, 48
- Start key, 5
- Stop, 5
- Storing
  - originals*, 110
  - program*, 112
- Superimpose, 137
- Supplementary specifications, 142
  - Erase*, 150
  - Margin Adjustment*, 151
- System indicators, 5

## T

---

- Text, 32
- Thin mode, 17
- Troubleshooting, 115
  - you cannot make clear copies*, 116
  - you cannot make copies as you want*, 117
  - your machine does not operate as you want*, 115
- Types of duplex copies, iv

## U

---

- User stamp, 137
  - changing position*, 99
  - delete*, 101
  - format*, 137
  - position and original orientation*, 98
  - program*, 99
  - program/delete*, 137
- User tools, 121
- User Tools/Counter key, 5

## W

---

- What you can do with this machine, iv

## Z

---

- Zoom, 143





MEMO



# Operating Instructions

## Connect Copy Reference

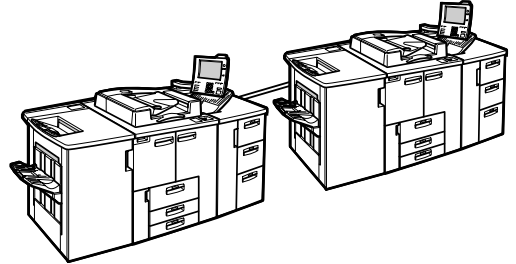

- 
- 1 Connect Copy
  - 2 Remarks
  - 3 Troubleshooting
  - 4 Specifications

## Introduction

This manual describes detailed instructions on the operation and notes about the use of this machine. To get maximum versatility from this machine all operators are requested to read this manual carefully and follow the instructions. Please keep this manual in a handy place near the machine.



### Notes

Some illustrations in this manual might be slightly different from the machine. Certain options might not be available in some countries. For details, please contact your local dealer.



### Notes:

Two kinds of size notation are employed in this manual. With this machine refer to the inch version.

# TABLE OF CONTENTS

How to Read This Manual .....	1
-------------------------------	---

## 1. Connect Copy

---

<b>What is Connect Copy?</b> .....	<b>3</b>
<b>How Connect Copy Works</b> .....	<b>5</b>
Connectable Options.....	5
Interrupt Functions .....	5
Before You Start.....	6
<b>Connect Copy Display Panel</b> .....	<b>7</b>
Sub-machine Display .....	8
<b>Using Connect Copy</b> .....	<b>10</b>
Exiting Connect Copy Mode.....	16
Copying Stored Documents with Connect Copy .....	17
<b>Presetting a Copy Job for Connect Copy</b> .....	<b>21</b>
<b>Connect Copy Job Allocation and Flow</b> .....	<b>23</b>
One of the Connected Machines Is Idle .....	23
Both Machines Are in Use.....	24
<b>Relationship between Main Machine and Sub-Machine System Settings</b> .....	<b>26</b>
<b>Relationship between Main Machine and Sub-Machine Copier</b>	
/Document Server Features .....	<b>29</b>
User Tools (Copier/Document Server Features).....	33

## 2. Remarks

---

Remarks.....	35
--------------	----

## 3. Troubleshooting

---

<b>If Your Machine Does Not Operate As You Want</b> .....	<b>37</b>
When a Message Appears .....	37
When the Service Call Indicator Is lit .....	38
Display .....	39
If Connect Copy Is Cleared .....	40
If You Cannot Exit Connect Copy .....	41
<b>If You Cannot Make Copies As You Want</b> .....	<b>43</b>
General .....	43

## 4. Specifications

---

Specifications.....	45
---------------------	----

INDEX.....	46
------------	----





# How to Read This Manual

---

## Symbols

---

In this manual, the following symbols are used:

 **WARNING:**

This symbol indicates a potentially hazardous situation that might result in death or serious injury if you use this machine without following the instructions under this symbol. Be sure to read these instructions, all of which are included in the Safety Information section.

 **CAUTION:**

This symbol indicates a potentially hazardous situation that might result in minor or moderate injury or material damage not involving physical injury if you use this machine without following the instructions under this symbol. Be sure to read these instructions, all of which are included in the Safety Information section.

- WARNINGS and CAUTIONS are notes for your safety.

 **Important**

If this instruction is not followed, paper might misfeed, originals may get damaged, and data might be lost. Be sure to read this.

 **Preparation**

This symbol indicates the prior knowledge or preparation required before operating.

 **Note**

This symbol indicates precautions for operation or actions to take after mal-operation.

 **Limitation**

This symbol indicates numerical limits, incompatible functions or conditions in which particular functions cannot be used.

 **Reference**

This symbol indicates a reference.

[   ]

Keys that appear on the machine's display panel.

[   ]

Keys built into the machine's control panel.



# 1. Connect Copy

## What is Connect Copy?

Connect Copy allows you to connect two machines together via a cable. When you set up a copy job on one machine (the main machine), data is transferred to the other (the sub-machine) so copies can be made on both machines simultaneously.

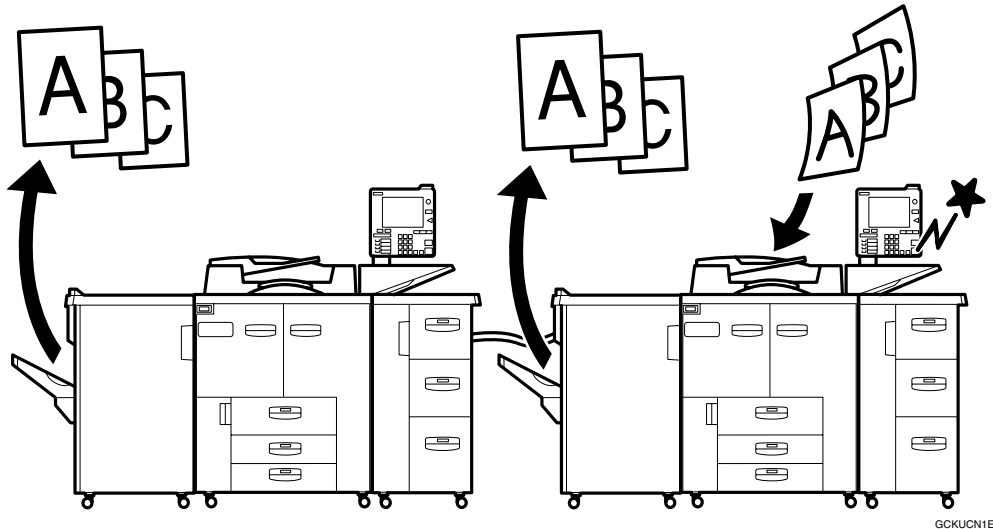

---

### Connect Copy Benefits

---

Connect Copy gives the user the following advantages:

❖ **High-speed copying for greater productivity (theoretical)**

For large volume copy runs, two connected machines form a single system that can complete the job in a shorter time. If two 85 copies/minute (A4  $\square$ , 8 $\frac{1}{2}$ "  $\square$   $\times$  11"  $\square$  size) copiers are connected together, a speed of 170 copies/minute (A4  $\square$ , 8 $\frac{1}{2}$ "  $\square$   $\times$  11"  $\square$  size) is available.

❖ **Auto-backup system for reduced operator participation**

Even if one machine stops due to a paper jamming, or running out of toner/paper, the other machine will automatically take over and finish the job.

 **Note**

- You cannot perform other copy jobs when two machines are working in copy connector mode.
- The two machines automatically share the job and finish it at almost the same time to provide maximum productivity.

- To separate the two machines again, press the  **[Connect]** key to disconnect them.
- When using the Sort/Staple function, copies are organized into copy sets. If there is a paper jam in one machine during this process, it is not possible for the other machine to take over processing the copy set of the inactive machine.

# How Connect Copy Works

In this manual, we refer to the two machines as main machine and sub-machine respectively.

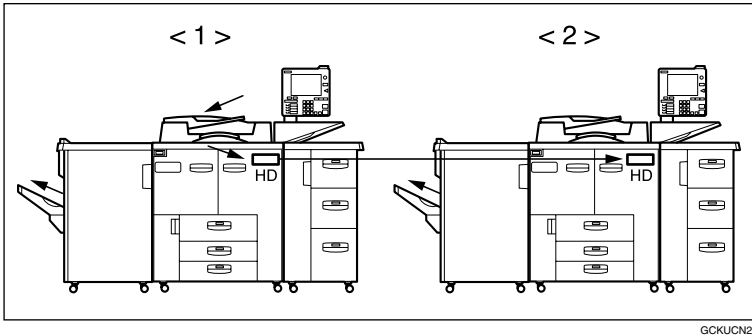

## 1. Main machine

## 2. Sub-machine

When your original is scanned, the image data is stored on the main machine's hard disk. As soon as the main machine starts copying, this data is transferred to the sub-machine's hard disk, and the sub-machine then starts copying.

The main machine is the machine where you press the  **[Connect]** key to make Connect Copy settings. When you do this, the other machine becomes the sub-machine.

You can use either machine as main machine or sub-machine, but you cannot change the relationship before first exiting Connect Copy mode.

---

## Connectable Options

---

You can still use Connect Copy even if no optional finisher or large capacity tray (LCT) is installed. However, the optional finisher must be installed in both machines to use the Staple and Punch functions, and the optional finisher and punch kit must be installed in both machines to use the Punch function.

---

## Interrupt Functions

---

- You cannot use Connect Copy when a job has been paused using the Interrupt function.
- You can use the Interrupt function on the sub-machine while in Connect Copy, not on the main machine.

---

## Before You Start

---

1

Both machines must have paper trays loaded with paper of the same size, direction and type that you want to copy onto.

To make the most out of the Connect Copy feature, we recommend that:

- The paper tray settings of the main machine and sub-machine match each other.
- The “Image Adjustment” of the User Tools settings are the same on each machine. See “General Features”, *Copy Reference*.

# Connect Copy Display Panel

This section describes main and sub-machine displays.

Note that when in Connect Copy mode, you must access all Connect Copy features and menus through the main machine display panel.

## ◆ Initial Display in Connect Copy Mode

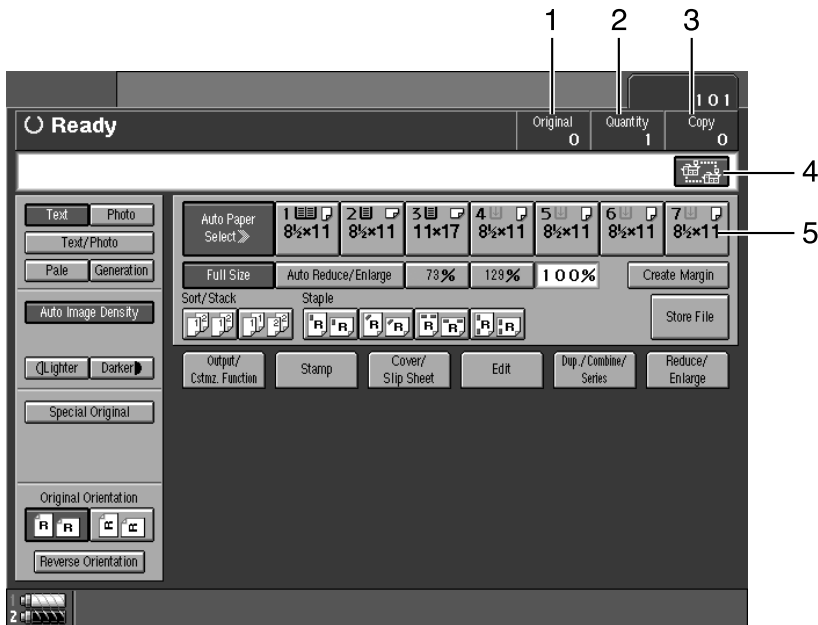

ZKUS030N

### 1. Number of originals

Number of original pages scanned by the main machine so far.

### 2. Number of sets

Number of sets yet to be made on the main machine.

### 3. Number of copies

Number of copies yet to be made on the main machine.

Pressing this displays the total number of copies made on the main machine and sub-machine.

### 4. [Connect] key

Press to switch the initial display from standard copy mode to connect copy mode.

### 5. Copy paper select

Only paper trays loaded with the paper of the same size, direction and type installed in both the main machine and sub-machine are displayed.

Other paper tray types will be grayed out and you cannot select them.

❖ Display when scanning originals on the main machine

1

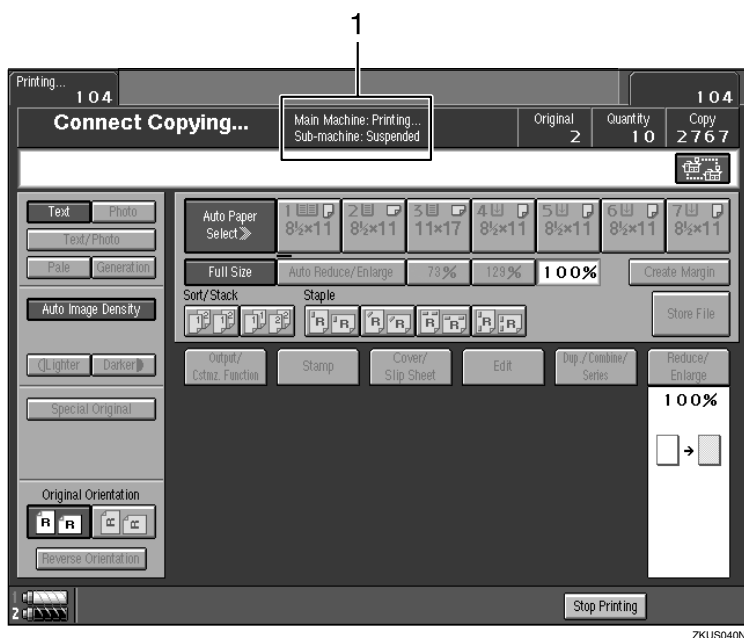

1. Displays the main machine and sub-machine status.

## Sub-machine Display

Even if Connect Copy is selected on the main machine, initial display in standard copy mode appears on the sub-machine. Follow the procedure below to switch to the initial display in Connect Copy mode.

**1** Press the **[Printer/Other Functions]** key on the sub-machine.

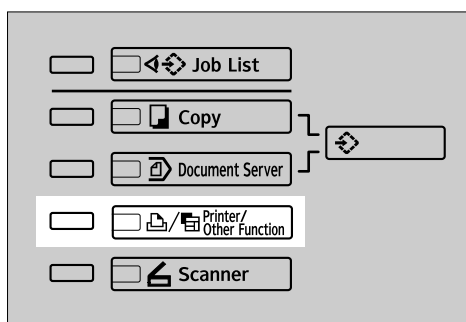



**2** Press the [Sub-machine] key.

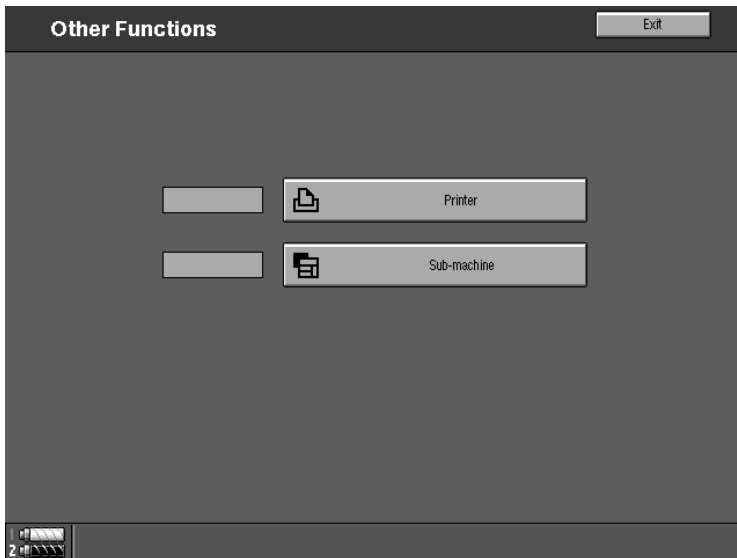

**3** The "Sub-machine" display appears.

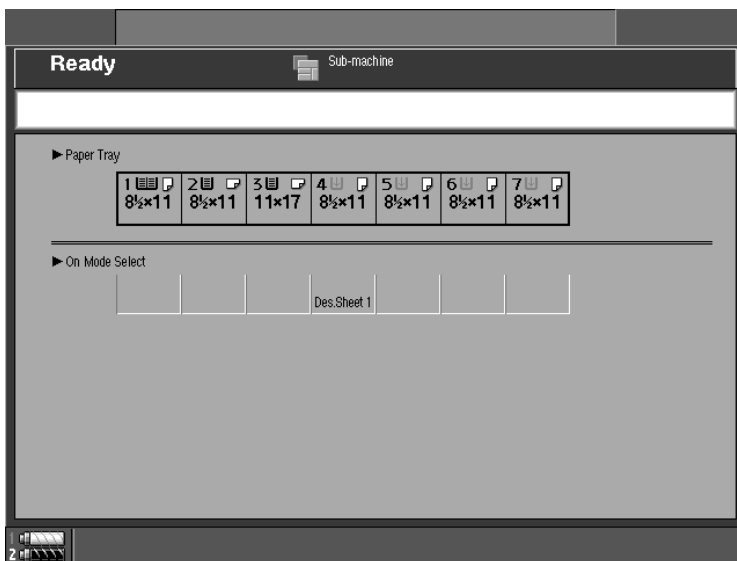

1

# Using Connect Copy

1

You can select Connect Copy mode from either machine by pressing the **[Connect]** key. The machine where you press the **[Connect]** key and make Connect Copy settings becomes the main machine, and the other machine becomes the sub-machine.

**Limitation**

- Once Connect Copy is selected, you must carry out all operations on the main machine.

**Note**

- You can have the **[Connect]** key displayed or not using the User Tools.

**Reference**

p.33 “User Tools (Copier/Document Server Features)”

**1 Make sure the machine is in Copy mode.**

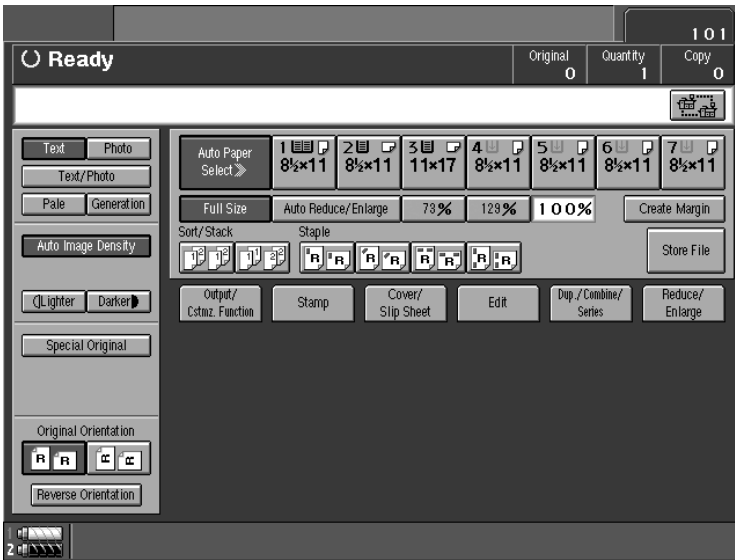

**Note**

- If user codes are enabled, enter a user code programmed in the main machine using the number keys (maximum eight digits), and then press the **[#]** key. You do not need to enter a user code for the sub-machine.

**Reference**

“User Management”, *General Settings Guide*

- 2** Press the  [Connect] key on the machine you want to use as the main machine.

When the key appears highlighted, the two machines are connected.

### ❖ Main machine display

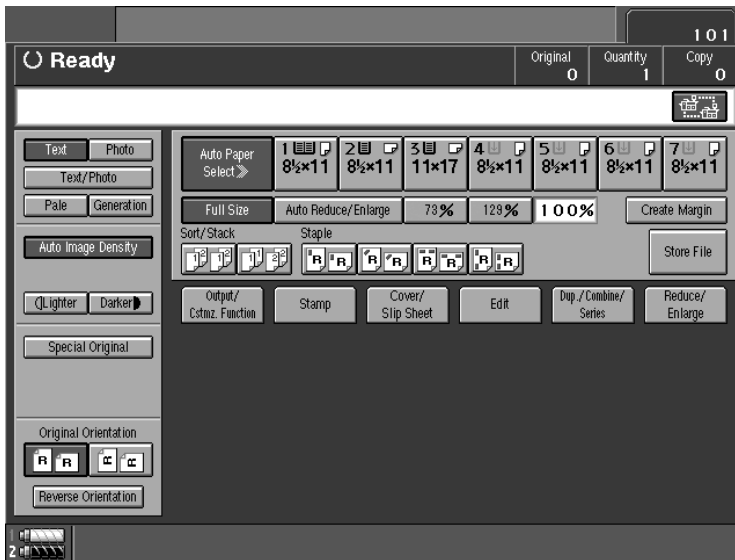

### ❖ Sub-machine display

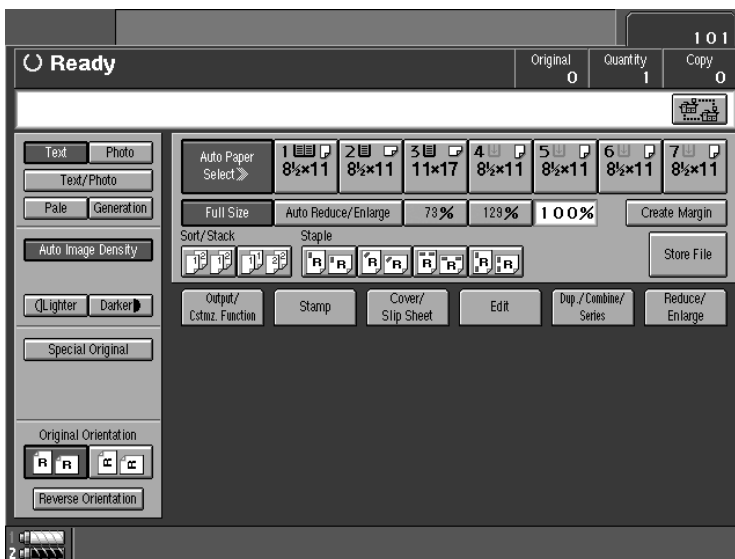





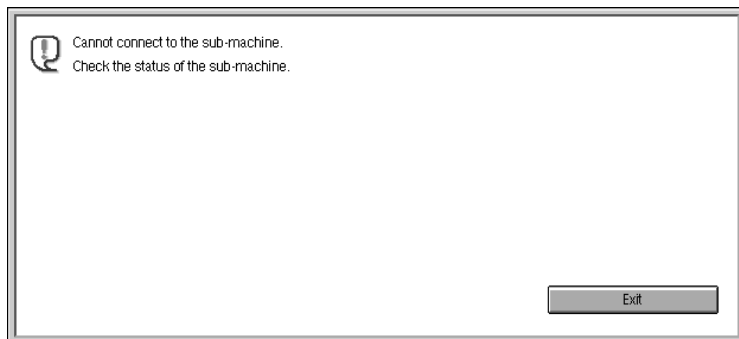







## Reference

If you press the  **[Connect]** key and the message “Cannot connect to the sub-machine. Check the status of the sub-machine.” appears, see p.37 “When a Message Appears”.



## 3 Set your originals in the main machine.

	Original	Exposure glass	Auto Document Feeder (ADF)
Standard			
			
90° Turn			
			

GCGSET10E

## Reference

“Placing Originals”, *Copy Reference*

## 4 Make the necessary settings on the main machine.

### Note

- Any copy settings made before entering Connect Copy mode remain in effect. However, if optional finishers are not installed on both main and sub-machine, the Stack, Staple and Punch functions are automatically disabled.
- To exit Connect Copy mode, press the  **[Connect]** key on the main machine again.

## Reference

For more information about functions you can use with Connect Copy, see “Functions that Require Options”, *Copy Reference*.

## 5 Enter the required number of copies using the number keys.

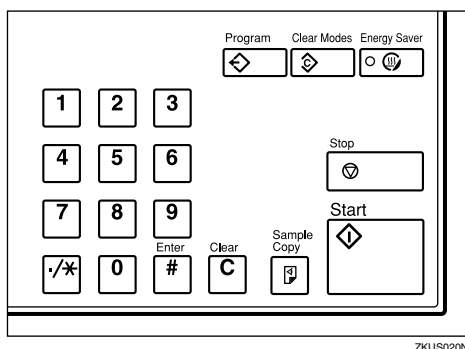

### Note

- You can enter up to 9999.
- If you make a mistake, press the **[Clear]** key and enter a new number.
- Although Connect Copy is selected, only the main machine copies, depending on number of copies and original type.

## 6 Press the **[Start]** key on the main machine.

Copying starts after the original is scanned.

Sub-machine copying starts when data transfer from the main machine is complete.

---

When setting originals on the exposure glass

---

- 1 Set the next page(s) when scanning has finished, and then press the **[Start]** key.
- 2 When all pages are scanned, press the **[#]** key.

### Note

- If the main machine is not in use, it starts copying.

---

When using Batch mode

---

- 1 Set your originals and press the **[Start]** key. After all previously set originals are fed, set the next set of originals.

### Note

- To stop originals being scanned or copied, press the **[Stop]** key on the main machine, and then press the **[Yes]** key following the instructions on the display.

**Reference**

“Batch mode”, *Copy Reference*

If the size of scanned data exceeds memory capacity, a memory overflow message appears. Follow the instructions in “When Memory Is Full”. See “When Memory Is Full”, *Copy Reference*.

**7 Pick up your copies from the main machine and sub-machine.**

**Note**

- Numbers of sheets and sets copied by main and sub-machine may differ.
- Main and sub-machine may not finish copying at the same time.
- When using the Sort/Staple function, copies are organized into copy sets. If there is a paper jam in one machine during this process, it is not possible for the other machine to take over processing the copy set of the inactive machine.

**Copy output order**

**When copying with the Sort/Staple function**

For example, copying six sets of a three sheet original

- Copying with the main machine (face down output)—sub-machine (face down output)

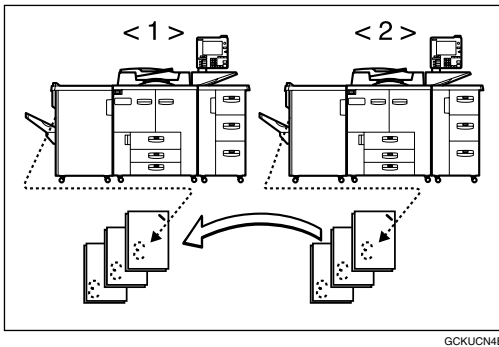

**1. Main machine**

**2. Sub-machine**

**Note**

- When using Sort/Staple, copy sets are not split between main and sub-machine.

## ◆ When copying with the stack function

For example, making two copies of each page of a six sheet original

- Copying with the main machine (face down output)—sub-machine (face up output)

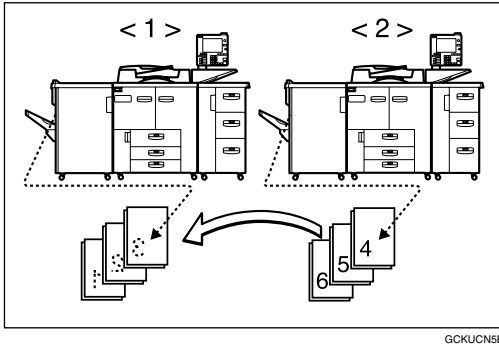

### 1. Main machine

### 2. Sub-machine

#### Note

- Combine copy stacks from main and sub-machine as shown in the diagram.

## System Reset

After a specified period of time elapses following job completion, the machine exits Connect Copy mode and automatically returns to the initial condition. This function is called “Auto Reset”.

#### Note

- When the main machine's “System Auto Reset Timer” period in User Tools elapses, the main machine resets automatically.
- When the sub-machine's “System Auto Reset Timer” period in User Tools (System Settings) elapses, sub-machine Interrupt mode cancels.

#### Reference

“System Auto Reset Timer”, *General Settings Guide*

### **Auto Off**

After a specified period of time following job completion, the machine automatically turns itself off. This function is called “Auto Off”. The sub machine does not turn itself off in Connect Copy mode.

#### **Note**

- You can change the Auto Off time.

#### **Reference**

“Auto Off Timer”, *General Settings Guide*

---

## Exiting Connect Copy Mode

---

This procedure describes how to exit Connect Copy mode and return to standard copying mode.

- 1** Press the  **[Connect]** key on the main machine.

The **[Connect]** key is deselected.

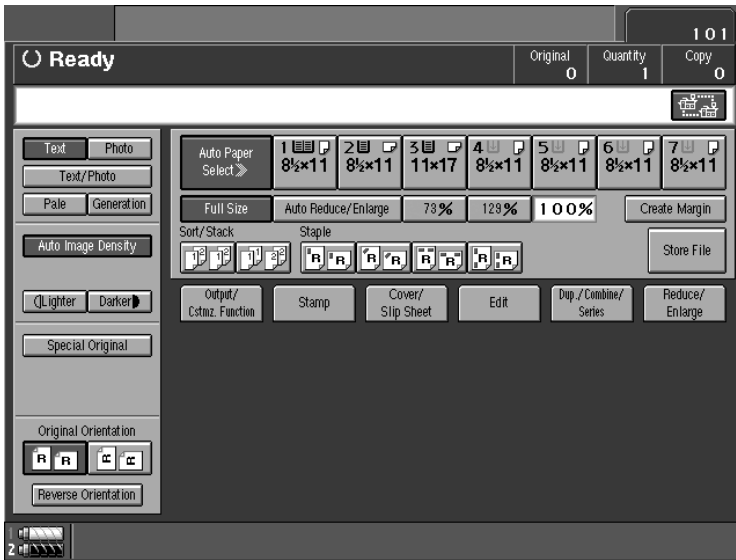

#### **Note**

- Settings selected on the main machine while in Connect Copy mode are not cleared.
- If you press the **[Clear Modes]** key on the main machine, Connect Copy mode is canceled and the main machine returns to the Copy mode initial condition.

#### **Reference**

If you cannot exit Connect Copy Mode by pressing the **[Connect]** key, see p.41 “If You Cannot Exit Connect Copy”.



## Copying Stored Documents with Connect Copy

You can print any document stored in the Document Server using Connect Copy.

### Note

- Use the machine that stored the documents in the Document Server as the main machine.

### **1** Press the **[Document Server]** key on the main machine.

The “Document Server: Files” display appears.

### **2** Press the line for the document you want to print.

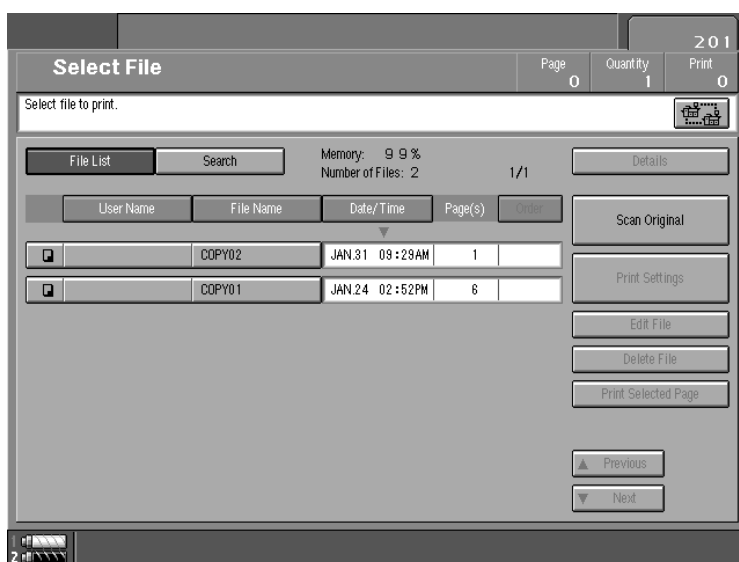

The selected line appears highlighted.

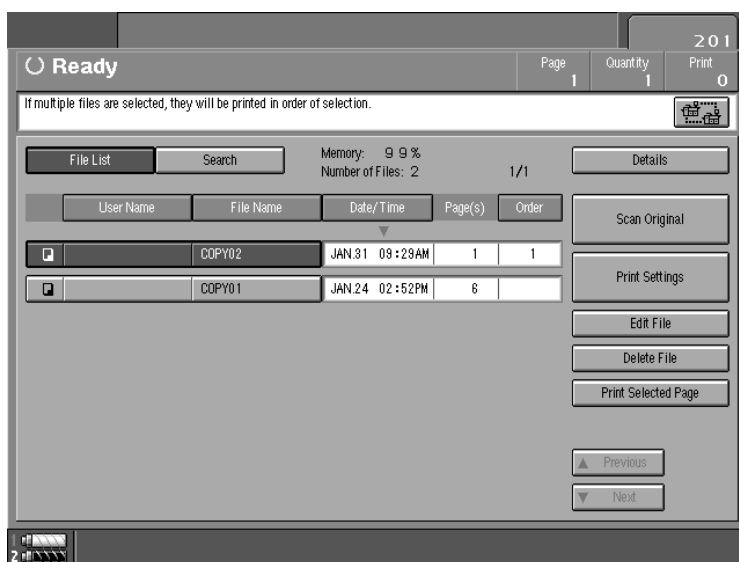

1

**Note**

- You can search for the document you desire by file name. See “Searching for Stored Documents”, *General Settings Guide*
- You can sort files in order of **[User Name]**, **[File Name]** or **[Date/Time]**. Press the key corresponding to your desired sort method.
- If the desired file name does not appear, look at the next or previous screens by pressing the **[▼ Next]** and **[▲ Previous]** keys.
- If you cannot identify the contents of a document by file name alone, you can print out the first page to check its contents. To do this, press the desired document's line, press the **[Print Selected Page]** key, and then press the **[1st Page Only]** key.
- Press the selected line again to cancel the print job.
- If a password is set, enter the password, and then press the **[OK]** key.

**3 To print more than one document, repeat step 2 to select them in the order you want to print.**

The selected order appears in the priority column next to the selected document(s).

**Note**

- To change the print order, press the line to deselect, and then select them again in the order you want to print.
- Press the **[Clear Modes]** key to cancel all the settings.

**4 If you need to change any print settings, press the [Print Settings] key.**

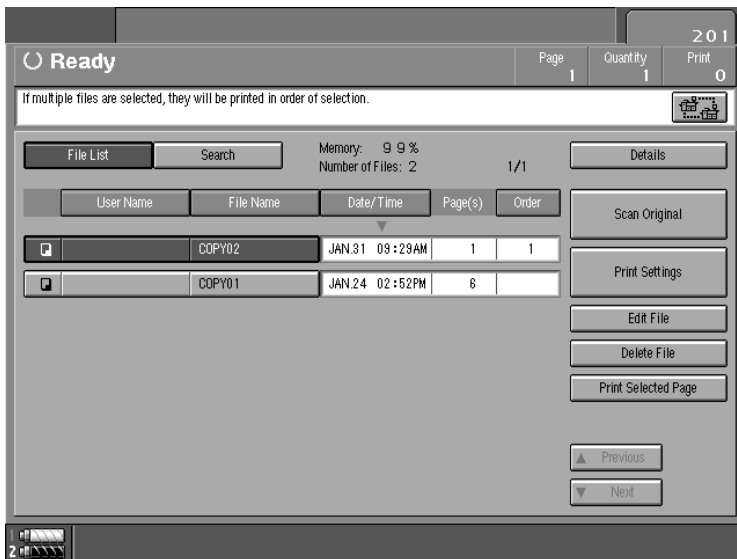

The “Document Server: Print Settings” display appears.

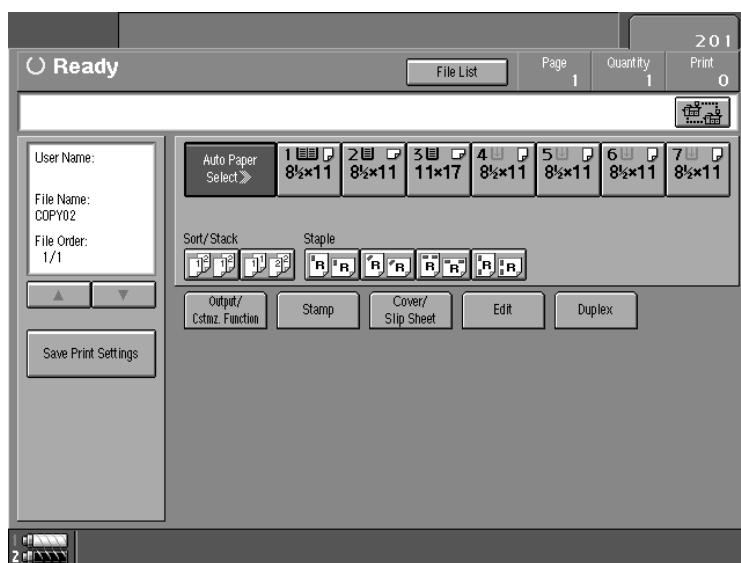

### Note

- Pressing the **[Save Print Settings]** key saves changes made to print and number of copies settings.
- If you select multiple files, you can check file names or print order of files selected in step **3** by scrolling through the list using the **[▼]** and **[▲]** keys.
- Press the **[File List]** key to return to the “Document Server: Select Files to Print” display.

### Reference

For details of printing settings, see the explanations of each function in this manual.

## 5 Press the **[Connect]** key.

When the key appears highlighted, the two machines are connected.

## 6 Enter the required number of prints using the number keys.

### Note

- Up to 9999 can be entered.
- To change an entered value, press the **[Clear]** key and enter a new value.
- You can check the contents of a Sort function multiple print job by printing a sample copy before beginning. See “Sample Copy”, *General Settings Guide*.
- Sample copying is possible only on the main machine when using Connect Copy.

**7** Press the **【Start】** key.

Copying starts after image data stored in the main machine is transferred to the sub-machine.

**Note**

- The main machine starts copying the document stored in the Document Server. Sub-machine copying starts when the document is transferred from the main machine, so there is a slight delay beforehand.
- To stop originals being printed, press the **【Stop】** key on the main machine, and then press the **【Yes】** key following the instructions on the display.
- Numbers of sheets and sets printed by main and sub-machine may differ.
- Main and sub-machine may not finish copying at the same time.

# Presetting a Copy Job for Connect Copy

You can reserve copy jobs in Connect Copy mode. Make Connect Copy settings for a copy job while the current job is in progress on the main machine. The copy job will start automatically in Connect Copy mode when the current job is complete.

## Note

- The maximum number of job sets you can set with this function is ten.

- On the main machine, check the message, "Press [New Job] to reserve a new job.", is displayed, and then press the [New Job] key.

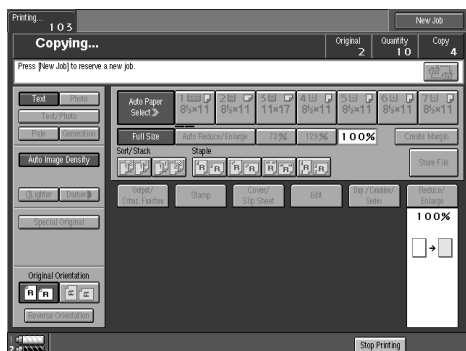

## Note

- The number that appears in the upper right of the display indicates preset copy jobs.
- To cancel the settings, press the [Clear Job] key.

- Check the message, "Ready", is displayed, and then press the [Connect] key.

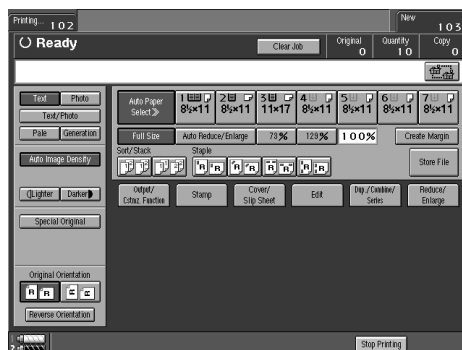

- Set your originals in the main machine.

- Check the message, "Ready", is displayed, and then make settings for the copy job.

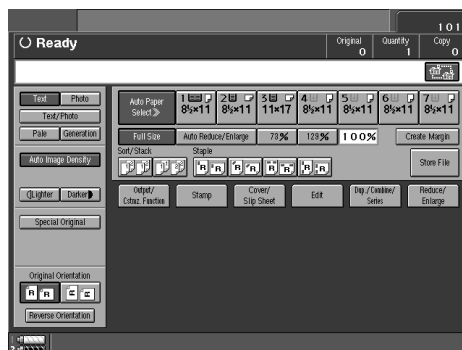

1

**5** Press the **[Start]** key on the main machine.

Scanning starts. As soon as the current copy job is complete, the copy job in Connect Copy mode will start automatically.

---

When setting originals in the Auto Document Feeder

---

- 1 The main machine scans originals. Sub-machine copying starts after data transfer from the main machine is complete.

---

When setting originals on the exposure glass

---

- 1 When the first page is scanned, set the next, and then press the **[Start]** key. Repeat this step until all pages are scanned.
- 2 The main machine scans originals. Sub-machine copying starts when data transfer from the main machine is complete.

 **Note**

- Settings for copy jobs in Connect Copy mode can be changed only when:
  - Main machine scanning of the copy job is complete.
  - Copying started from neither main nor sub-machine.

 **Reference**

“Editing job preset”, *Copy Reference*

# Connect Copy Job Allocation and Flow

Depending on the status of the connected machines, allocation and flow of copy jobs will differ.

## One of the Connected Machines Is Idle

The other machine copies original A.

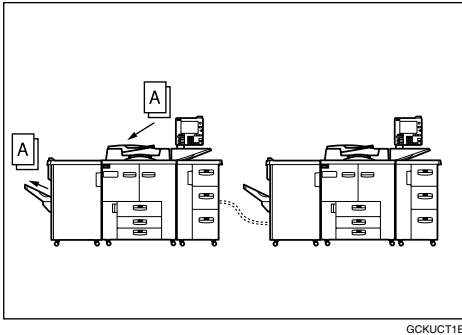

## When the idle machine is the main machine (Connect Copy)

**1** Make Connect Copy settings for original B on the machine <2>.

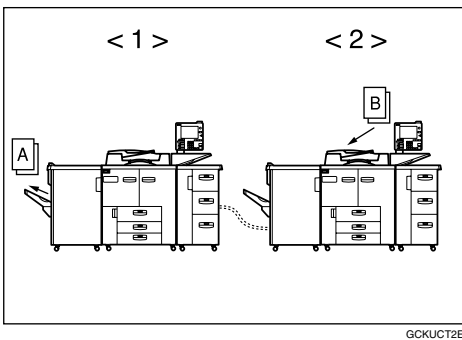

**2** The machine <2> starts copying original B. The machine <1> starts copying original B after it finishes copying original A.

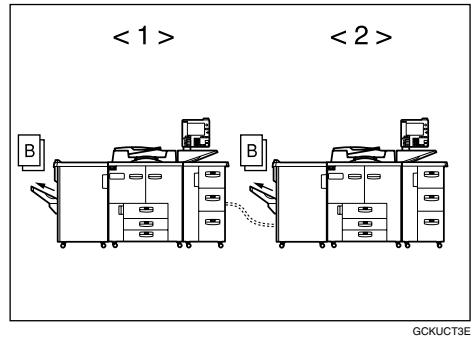

1. Sub-machine
2. Main machine

## When the machine currently copying is the main machine (Connect Copy: Reserved)

**1** Make Connect Copy settings for original B on the machine <1>.

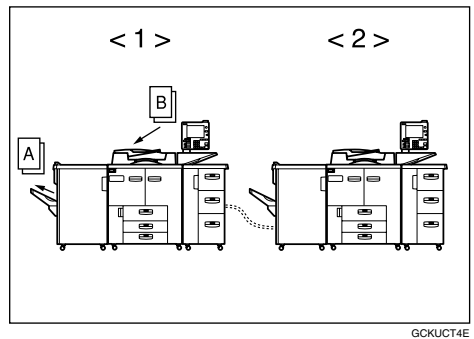

**2** When the machine <1> finishes copying original A, Connect Copy starts, copying original B from both main and sub-machine.

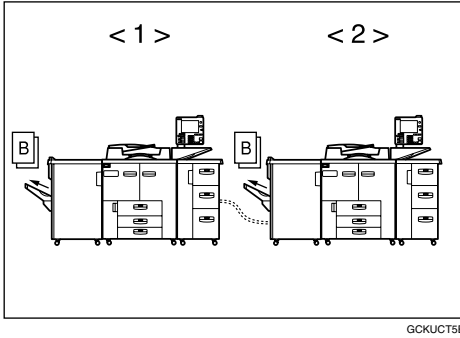

1. Sub-machine
2. Main machine

**Both Machines Are in Use**

One of the connected machines is copying original A, the other, original B.

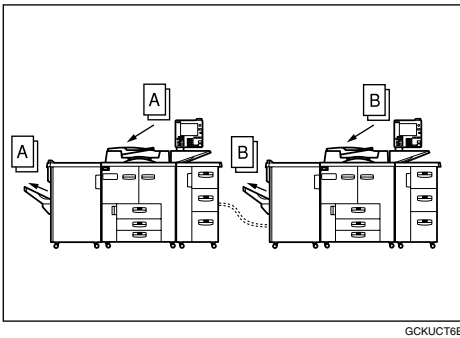

**When both machines have similar numbers of originals (Connect Copy: Reserved)**

**1** Make Connect Copy settings for original C on the machine <1>.

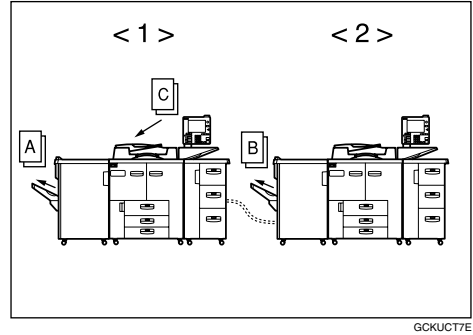

**2** When the machine <1> finishes copying original A, it starts copying original C.

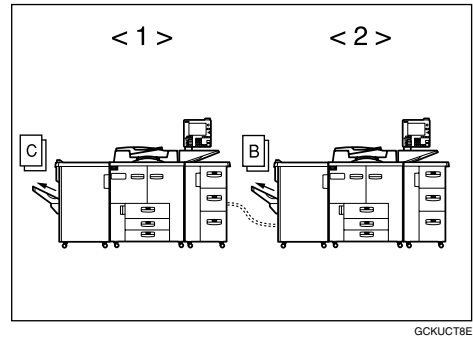

**3** When the machine <2> finishes copying original B, Connect Copy starts copying original C from both main and sub-machine.

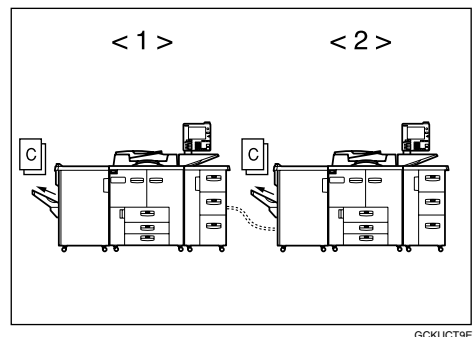

1. Sub-machine
2. Main machine



**When one of the connected machines has a higher number of originals (Connect Copy: Reserved)**

- 1** Make Connect Copy settings for original C on the machine <1>.

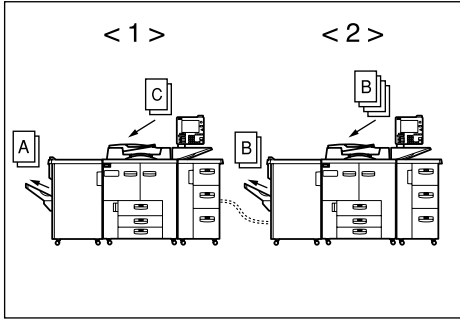

GCKUCTAE

- 2** When the machine <1> finishes copying original A, it starts copying original C. If the machine <2> has not finished copying original B when the machine <1> finishes its allocated copies of original C, the machine <1> takes over the remaining copying of original C to complete the job.

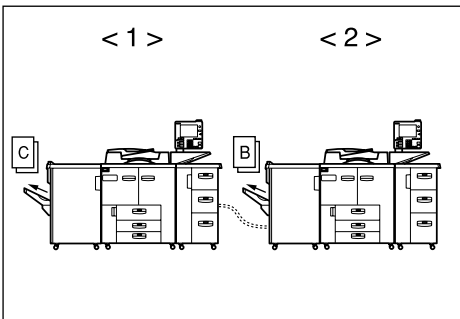

GCKUCTBE

1. Sub-machine
2. Main machine

# Relationship between Main Machine and Sub-Machine System Settings

1

This section describes System Settings used by the main machine and sub-machine in Connect Copy mode.

## Note

- ❑ To access the sub-machine User Tools, exit Connect Copy mode by pressing the highlighted  **[Connect]** key on the main machine.

## Reference

*General Settings Guide*

Symbol	Meaning
☆	The main machine and sub-machine setting is independent
←	Both machines use the main machine setting
—	Unrelated
★	Depends on the function

## ◆ General Features

Menu	Main machine	Sub-machine	Remarks
Panel Tone	☆	☆	
Warm Up Notice	☆	☆	
Copy Count Display	—	—	The copy counter always displays as count up.
Function Priority	—	—	When the time set in “System Auto Reset Timer” in User Tools on the main machine passes and Connect Copy is canceled, and then the time set in “System Auto Reset Timer” passes, the function selected in “Function Priority” returns.
Print Priority	—	—	
Function Reset Timer	—	—	
Interleave Print	—	—	
Status Indicator	☆	☆	
Screen Color Setting	☆	☆	
Output: Copier	☆	☆	
Output: Document Server	☆	☆	
Output: Printer	☆	☆	
Paper Tray Priority: Copier	☆	☆	
Paper Tray Priority: Printer	☆	☆	

Menu	Main machine	Sub-machine	Remarks
Job List Display Time	☆	—	
Time Interval between Printing Jobs	☆	—	
ADF Original Table Elevation	☆	—	
ADF Feed Speed	☆	—	
Optimum for Thick Paper	☆	—	

### ❖ Timer Settings

Menu	Main machine	Sub-machine	Remarks
Auto Off Timer	☆	—	
Energy Saver Timer	—	—	In Connect Copy mode, neither machine will enter any Energy Saver modes (Low Power mode, Energy Saver mode). When Connect Copy is exited, the machines will enter Energy Saver mode when the specified period has elapsed.
Panel Off Timer	—	—	
System Auto Reset Timer	—	★	Interrupt mode on the sub-machine is cleared by this timer.
Copier/ Document Server Auto Reset Timer	—	—	
Scanner Auto Reset Timer	—	—	Date settings depend on the main machine.
Set Date	☆	☆	
Set Time	☆	☆	
Weekly Timer Code	—	—	The function is disabled on the main machine in Connect Copy Mode. When Connect Copy is exited, the power will switch off at the time specified by the timer.
Weekly Timer: Monday	☆	—	
Weekly Timer: Tuesday	☆	—	
Weekly Timer: Wednesday	☆	—	
Weekly Timer: Thursday	☆	—	
Weekly Timer: Friday	☆	—	
Weekly Timer: Saturday	☆	—	
Weekly Timer: Sunday	☆	—	

## ◆ Key Operator Tools

Menu	Main machine	Sub-machine	Remarks
User Code Management	☆	—	Access these settings through the main machine. Main machine settings override those of the sub-machine.
Key Counter Management	—	—	Access these settings through the main machine. Main machine settings override those of the sub-machine.
External Charge Unit Management	—	—	Access these settings through the main machine. Main machine settings override those of the sub-machine.
Key Operator Code	—	—	When <b>[All Features]</b> is selected, the sub-machines operates according to main machine settings.
Display User Code	—	—	
Display/ Print Counter	—	—	
Display/Clear/Print Counter per User Code	—	—	In Connect Copy mode, the number of copies on the sub-machine is shown in User Code on the main machine.
Print Address Book	—	—	
Address Book Management	—	—	
Address Book: Program/Change/Delete Group	—	—	
Address Book: Change Order	—	—	
Address Book: Edit Title	—	—	
Select Title	—	—	
Auto Delete File	—	—	
Delete All Files	—	—	
Extended Security	—	—	
Password Management for Stored Files	—	—	
Key Operator's E-mail Address	—	—	
AOF (Always On)	—	—	Neither the main machine nor sub-machine is turned off by this function while in Connect Copy mode. The power will go off after you exit Connect Copy mode and the AOF Delay has elapsed.

# Relationship between Main Machine and Sub-Machine Copier/Document Server Features

This section describes Copier/Document Server Features used by the main machine and sub-machine in Connect Copy mode.

## Note

- When Connect Copying, the **[User Tools]** key on the sub-machine is disabled. To access User Tools on the sub-machine, you need to exit Connect Copy mode first.

## Reference

*Copy Reference*

Symbol	Meaning
☆	The main machine and sub-machine setting is independent
←	Both machines use the main machine setting
—	Unrelated

## ◆ General Features

Menu	Main machine	Sub-machine	Remarks
Auto Paper Select Priority	☆	—	Tray with the same size and direction of paper are selected from the main machine and sub-machine automatically.
Auto Image Density Priority	☆	—	
Original Type Priority	☆	—	
Duplex Mode Priority	☆	—	
Original Orientation in Duplex Mode	☆	—	
Copy Orientation in Duplex Mode	☆	—	
Change Initial Mode	☆	—	
Reserve Job Mode	☆	—	
Max. Number of Sets	☆	—	
Manual Original Counter Reset	☆	—	
Auto Tray Switching	☆	☆	

## ❖ Image Adjustment

Menu	Main machine	Sub-machine	Remarks
Text	☆	☆	
Text/ Photo	☆	☆	
Photo	☆	☆	
Pale	☆	☆	
Generation Copy	☆	☆	
Dark Background	☆	☆	

## ❖ Display/ Tone

Menu	Main machine	Sub-machine	Remarks
Original Type Display	☆	—	
Special Original Display	☆	—	
Paper Display	☆	—	The sub-machine will always display the paper type, regardless of whether or not this function is selected.
Panel Features Default	☆	—	
Image Adjustment Priority	☆	—	
Tone: Original Remains	☆	—	
Job End Call	☆	☆	When turned on, only the main machine beeper sounds when copying is complete. (If the "Panel Tone" of System Settings is set to "Low", "Medium" or "High".
Customize Function: Copy	☆	—	
Customize Function:Store Document Server	☆	—	
Customize Function:Print Document Server	☆	—	
Special Original Display Defaults	☆	—	
Connect Copy Key Display	☆	☆	

❖ **Reproduction Ratio**

Menu	Main machine	Sub-machine	Remarks
Preset Reduce/ Enlarge	☆	—	
Preset Reduce/ Enlarge Priority	☆	—	
Shortcut R/ E	☆	—	
Create Margin Ratio	☆	—	

❖ **Edit**

Menu	Main machine	Sub-machine	Remarks
Copy Back Cover	☆	←	
Front Page Margin: Left/ Right	☆	←	
Back Side Margin: Left/ Right	☆	←	
Front Side Margin: Top/ Bottom	☆	←	
Back Side Margin: Top/ Bottom	☆	←	
1 → 2 Sided Auto Back Side Margin: T to T	☆	←	
1 → 2 Sided Auto Back Side Margin: T to B	☆	←	
Erase Border Width	☆	←	
Erase Original Shadow in Combine	☆	←	
Erase Center Width	☆	←	
Image Repeat Separation Line	☆	←	
Double Copies Separation Line	☆	←	
Separation Line in Combine	☆	←	
Copy Order in Combine	☆	←	
Orientation: Booklet, Magazine	☆	←	
Front Cover Copy in Combine	☆	←	
Copy on Designating Page in Combine	☆	←	
Double Copies Position	☆	←	

## ◆ Stamp

Menu	Main machine	Sub-machine	Remarks
<b>Background Numbering</b>			
Size	☆	←	
Density	☆	←	
<b>Preset Stamp</b>			
Stamp Language	☆	←	Main machine settings always take priority, but it is best to match settings on both machines.
Stamp Priority	☆	←	
Stamp Format	☆	←	
<b>User Stamp</b>			
Program/ Delete Stamp	☆	←	Make the same stamp settings on both machines.
Stamp Format	☆	←	
<b>Date Stamp</b>			
Stamp Format	☆	←	
Stamp Font	☆	←	
Stamp Position	☆	←	
Page to Stamp	☆	←	
Stamp Size	☆	←	
Superimpose	☆	←	
<b>Page Numbering</b>			
Stamp Format	☆	←	
Stamp Font	☆	←	
Stamp Size	☆	←	
Back Side Stamp Position in Duplex	☆	←	
Page Numbering in Combine	☆	←	
Stamp on Designation Sheet Page	☆	←	
Superimpose	☆	←	
Stamp Position: P1,P2	☆	←	
Stamp Position: 1/5,2/5	☆	←	
Stamp Position:-1,-2-	☆	←	
Stamp Position: P.1,P.2	☆	←	
Stamp Position: 1,2	☆	←	



Menu	Main machine	Sub-machine	Remarks
Stamp Position: 1-1,2-2	☆	←	
<b>Stamp Text</b>			
Stamp Font	☆	←	
Stamp Position	☆	←	
Page to Stamp	☆	←	
Stamp Size	☆	←	
Superimpose	☆	←	

### ❖ Input/Output

Menu	Main machine	Sub-machine	Remarks
SADF Auto Reset	☆	—	
Eject Copy Face Up/ Down in Glass Mode	—	—	In Connect Copy mode, this setting is ineffective when using functions such as Sort/Staple and Stack.
Auto Sort	☆	—	
Memory Full Auto Scan Restart	☆	←	
Sort/Stack Shift Tray Setting	☆	—	
Insert Separation Sheet	☆	←	
Select Staple Position	☆	—	
Letterhead Setting	☆	←	

## User Tools (Copier/Document Server Features)

### General Features

#### ❖ Connect key

You can select whether or not to display the  [Connect] key. If you select [Hide], it will not be displayed and this machine cannot be used as the main machine.

#### Note

Default: *Display*

1

## Remarks

### Important

- ❑ Do not connect any other equipment to the Connect Copy port.
- ❑ Be sure to turn off the main power switch on both main and sub-machine before disconnecting the Connect Copy cable. Unplugging it while the power is on could damage the machines.

### Note

- ❑ You can store the setting to automatically select the Connect Copy function in a program.
- ❑ In Connect Copy mode, select the copy paper in the main machine.
  - When you press the **[Connect]** key, only paper trays that with the same settings in both machines are displayed. Other trays appear grayed out and cannot be selected.
  - If multiple trays are available in Connect Copy mode, each machine selects the paper tray detected in each "Paper Tray Priority" setting. See "Tray Paper Settings", *General Settings Guide*.
  - If the sub-machine paper tray in use runs out of paper, the paper tray with the same size paper but different direction is selected, and the original image is rotated (if "With Image Rotation" is selected in "Auto Tray Switching"). See "General Features 1/5", *Copy Reference*.
- ❑ If you press the **[Clear Modes]** key while making Connect Copy settings, Connect Copy mode is canceled and the standard copy mode initial display returns.
- ❑ In Connect Copy mode, even if the sub-machine is still in Energy Saver mode, it starts copying automatically.
- ❑ In Connect Copy mode, after finishing a sub-machine interrupt copy job, be sure to exit Interrupt mode on the sub-machine.
- ❑ The job in Connect Copy mode appears in the sub-machine Job List; however, it cannot be deleted from that machine.
- ❑ You can turn user codes on or off with the main machine User Tools (System Settings).
  - You can monitor the total number of copies made by main and sub-machine with the main machine's user codes function.
  - If user codes are set to on in the sub-machine and a code was entered before Connect Copy was selected, the main machine cannot record the number of copies made.
  - If user codes are set to on in the sub-machine only, you can enter Connect Copy mode and make copies without entering a code. In this case the number of copies made, not recorded.

 **Reference**

For details about how to set up User Codes, see “Key Operator Tools”, *General Settings Guide*.



For details about how to register, change and delete User Codes, see “User Codes”, *General Settings Guide*.

# 3. Troubleshooting

## If Your Machine Does Not Operate As You Want

### When a Message Appears

#### ❖ Main Machine

Message	Causes	Solutions
Cannot connect to the sub-machine. Check the status of the sub-machine.	 indicator is lit.	Press the <b>[Exit]</b> key on the main machine, and then follow the instructions on the display.
	Hard disk error on the sub-machine	Press the <b>[Exit]</b> key on the main machine, and then follow the instructions on the display.
Sub-machine is in Interrupt mode.	The sub-machine is in Interrupt mode.	Press the <b>[Interrupt]</b> key on the sub-machine to exit Interrupt mode.  <b>Reference</b> "Interrupt Copy", <i>Copy Reference</i>
Sub-machine does not have the same paper setting(s).	Paper type or tray set on the sub-machine is not the same as that set on the main machine.	Match paper type or tray on main and sub-machine.
The Cover Sheet setting(s) of the sub-machine is different from the main machine.	Cover settings on the main machine and sub-machine are different.	Match settings on main and sub-machine.
The Slip Sheet N setting(s) of the sub-machine is different from the main machine.	Designate settings on the main machine and sub-machine are different.	Match settings on main and sub-machine.
The Slip Sheet setting(s) of the sub-machine is different from the main machine.	Slip Sheet settings on the main machine and sub-machine are different.	Match settings on the main machine and sub-machine.
This tray is unavailable because the sub-machine does not have the same paper setting(s).	The grayed out tray is selected because the paper type is different.	Select the tray that is not grayed out.

Message	Causes	Solutions
No stamp data in the sub-machine.	The programmed sub-machine stamp was deleted before making print settings and copying on the main machine.	Program the stamp on the sub-machine and make the stamp settings again.
Sub-machine memory is full. Sub-machine will be disconnected.	Sub-machine memory reached capacity during connect copying.	Continue copying on the main machine.
Cannot print from the sub-machine. Sub-machine will be disconnected.	Sub-machine was stopped during connect copying due to power failure or communication error.	Continue copying on the main machine.

❖ **Sub-Machine**

Message	Causes	Solutions
Cannot connect Check the main power switch of the sub-machine or the cable to connect.	Sub-machine was stopped during connect copying due to power failure or communication error.	Continue copying on the main machine.



---

## When the Service Call Indicator Is lit



---

Problem	Causes	Solutions
An error message indicating a breakdown appears on the display.	ⓘ indicator is lit.	<ul style="list-style-type: none"> <li>Follow the instructions on the display.</li> <li>Exit Connect Copy mode, and continue copying on the main machine where the error message no longer appears.</li> </ul>

## Display





Problem	Causes	Solutions
The <b>[Connect]</b> key does not appear on the display.	The sub-machine's main power switch is off.	Turn the sub-machine's main power switch on.
	Functions that cannot be used with Connect Copy are selected on the main machine, such as copying the first page and storing documents in Document Server mode.	Cancel the selected function that cannot be used in Connect Copy mode.
	The main machine is in Interrupt mode.	Press the <b>[Interrupt]</b> key on the main machine to exit Interrupt mode.
	The "Connect Copy Key Display" of the User Tools setting is "Hide".	Change the setting to "Display" or press the <b>[Connect]</b> key on the other machine.   <b>Reference</b> p.10 "Using Connect Copy"
	The Connect Copy cable is damaged.	Contact your service representative.
	 indicator is lit.	Follow the instructions on the display.
The <b>[Connect]</b> key is grayed out.	Functions are programmed that cannot be used with Connect Copy.	Press the main machine <b>[Clear Modes]</b> key to clear the programmed functions.   <b>Reference</b> "Functions that Require Options", <i>Copy Reference</i> .







## If Connect Copy Is Cleared

Problem	Causes	Solutions
Exited Connect Copy.	The main machine's main power switch is turned off or the operation switch was pressed.	Connect Copy is canceled. On the main machine, either turn on the main power switch or press the operation switch, and then press the <b>[Connect]</b> key and start your copy job again.
	The sub-machine main power switch is turned off.	A message requesting you to check the sub-machine appears on the main machine. Press the <b>[Exit]</b> key and clear connect-copying. Copying continues on the main machine only. Turn on the sub-machine's main power switch, press the <b>[Connect]</b> key, and then make the settings again.
	The Weekly Timer function has automatically turned off the main machine.	Press the main machine operation switch to "On", then press the <b>[Connect]</b> key and begin copying.   <b>Reference</b> "Weekly Timer Code", <i>General Settings Guide.</i>
An error message indicating a breakdown is shown on the main machine display.	 indicator is lit.	Copying is not possible. Follow the instructions in the error message.



## If You Cannot Exit Connect Copy

Machine Status	Causes	Solutions
Nothing happens when you press the  [Connect] key.	Originals are being scanned or copied.	Press the main machine <b>[Stop]</b> key and then press <b>[Yes]</b> key to cancel scanning or copying.
	There is a paper misfeed in either the main machine or sub-machine.	Clear the paper jam in the main machine or sub-machine.   <b>Reference</b> “  Clearing Missfeed”, General settings Guide “  Removing Jammed Staples”, General settings Guide  If the “Open Cover” display appears, follow the instructions given.  For any other problems, follow the instructions that are displayed.  To exit Connect Copy mode, press the main machine <b>[Stop]</b> key, then press the <b>[Connect]</b> key.
	The main machine <b>[Stop]</b> key was pressed and scanning of the original has been interrupted.	To exit Connect Copy mode, follow the instructions on the display, then press the <b>[Yes]</b> key.
	The <b>[Stop]</b> key was pressed on either the main machine or sub-machine and copying has been interrupted.	To exit Connect Copy mode, follow the instructions on the display, then press the <b>[Yes]</b> key.

Machine Status	Causes	Solutions
Nothing happens when you press the  <b>[Connect]</b> key.	The main machine or sub-machine needs a fresh supply of toner or staples.	Solve the problem in the appropriate unit.   <b>Reference</b> “  Loading Paper”, General settings Guide “  Changing the Toner Bottle”, General settings Guide “  Adding Staples”, General settings Guide “  Removing Punch Waste”, General settings Guide  For any other problems, follow the instructions that are displayed.  To exit Connect Copy mode, press the main machine <b>[Stop]</b> key. then press the <b>[Yes]</b> key.
	A paper misfeed occurred during stapling.	Remove the misfed paper.  To exit Connect Copy mode, press the <b>[Stop]</b> key, then press the <b>[Connect]</b> key.

# If You Cannot Make Copies As You Want

## General

Problem	Causes	Solutions
Cannot staple or punch.	The optional finisher or punch kit is not installed in the sub-machine.	Press the <b>[Connect]</b> key to exit Connect Copy mode, and then copy using staple/punch.
The copied images differ.	"Image Adjustment" set in User Tools is not the same.	"General Features", <i>Copy Reference</i>
	The options (finisher or booklet finisher installed on main and sub-machine are different.	Press the <b>[Connect]</b> key to exit Connect Copy mode, and then copy using stack/staple/punch.



# 4. Specifications

## Specifications

- ❖ **Theoretical continuous copying speed (85 copies/per minute — 85 copies/per minute):**
  - 170 copies/per minute (A4, 8<sup>1</sup>/<sub>2</sub> × 11 in)
  - 82 copies/per minute (A3, 11 × 17 in)
- ❖ **Theoretical continuous copying speed (85 copies/per minute — 105 copies/per minute):**
  - 190 copies/per minute (A4, 8<sup>1</sup>/<sub>2</sub> × 11 in)
  - 90 copies/per minute (A3, 11 × 17 in)
- ❖ **Theoretical continuous copying speed (105 copies/per minute — 105 copies/per minute):**
  - 210 copies/per minute (A4, 8<sup>1</sup>/<sub>2</sub> × 11 in)
  - 98 copies/per minute (A3, 11 × 17 in)
- ❖ **Maximum continuous copy run:**  
9999 sets

# INDEX

## C

---

- Connect Copy, 3, 10
  - Exiting*, 16
  - Presetting*, 21
- Copier/Document Server Features, 29

## F

---

- Finisher, 5

## I

---

- Image Adjustment, 6

## M

---

- Main machine, 5, 7

## O

---

- Originals, 12

## S

---

- Specifications, 45
- Sub-machine, 5, 7
- Symbols, 1
- System Reset, 15
- System Setting, 26
  - Copier/Document Server Features*, 29

## U

---

- User Code, 10

## Note to users in the United States of America

### Notice:

This equipment has been tested and found to comply with the limits for a Class A digital devices, pursuant to Part 15 of the FCC Rules. These limits are designed to provide reasonable protection against harmful interference when the equipment is operated in a commercial environment. This equipment generates, uses, and can radiate radio frequency energy and, if not installed and used in accordance with the instruction manual, might cause harmful interference to radio communications. Operation of this equipment in a residential area is likely to cause harmful interference in which case the user will be required to correct the interference at his own expense.

### Warning

Changes or modifications not expressly approved by the party responsible for compliance could void the user's authority to operate the equipment.

## Note to users in Canada

### Warning:

This Class A digital apparatus complies with Canadian ICES-003.

## Remarque concernant les utilisateurs au Canada

### Avertissement:

Cet appareil numérique de la classe A est conforme à la norme NMB-003 du Canada.

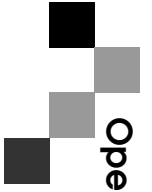

**Operating Instructions   Connect Copy Reference**